



TRANE

Installation Operation Maintenance

CMAF Air-to-water Multi-pipe Scroll Unit

Cooling capacity: 142-323 kW

Heating capacity (Heat Pump mode): 146 - 344 kW

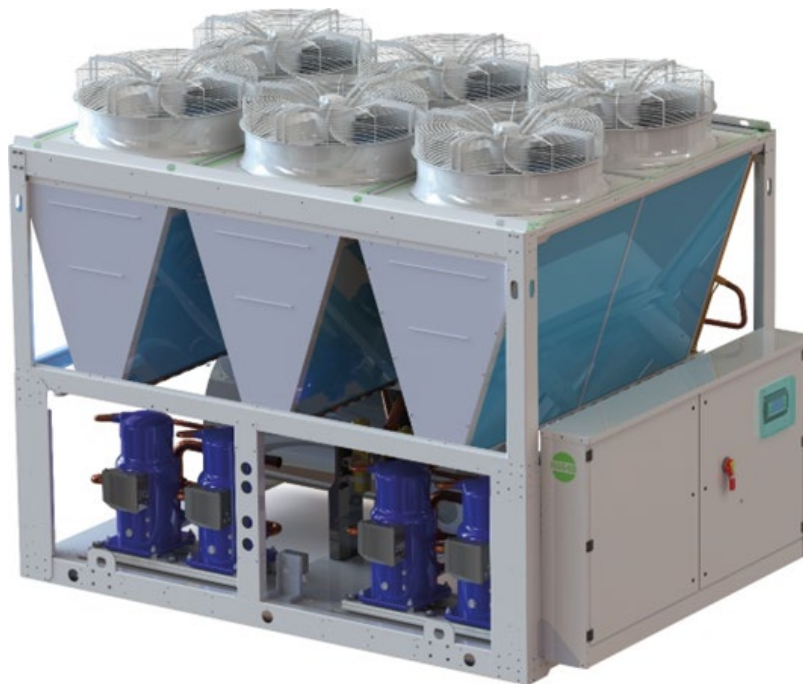

July 2023

CG-SVX062B-GB

Confidential and proprietary Trane information
Original instructions

TRANE
TECHNOLOGIES



Contents

Contents	2
General Information	8
Foreword	8
Warnings and Cautions	8
Safety Recommendations	8
Reception.....	8
Warranty.....	9
Maintenance contract	9
Training	9
Refrigerant	9
Unit Description	10
Nameplates.....	10
Unit Nameplate	10
Compressor Nameplate	10
Unit model number description	11
Pre-Installation	13
Inspection checklist.....	13
Mandatory Start-up Checklist.....	13
Unit storage	13
General Data	15
Table 1 - General data CMAF 040-045-050-055-065 SE (standard efficiency):	15
Table 2 - General data CMAF 070-075-085-095-105 SE (standard efficiency):	19
Table 3 - General data CMAF 040-045-050-055-065 HE (high efficiency):	23
Table 4 - General data CMAF 070-075-085-095-105 HE (high efficiency):	27

Typical component's location	31
General view	31
Illustration of Hydraulic module	32
Installation Requirements	33
Location Requirements.....	33
Installation Responsibilities	33
Lifting and Moving Instructions.....	33
Dimension andWeights	34
Center of Gravity.....	34
Unit Isolation and Leveling	34
Elastomeric Isolators Installation(Optional).....	34
Chilled/hot water piping.....	35
Drainage.....	35
WaterTreatment	35
Piping	35
Entering Water Piping.....	36
Leaving Water Piping	36
Pressure Gauges.....	36
Chilled/Hot Water Flow Switch	36
Minimum/recommended watercontent	37
Chilled/hot water exchanger pressure drop	39
Integrated pump package	39
Installation - Mechanical (Water pumps)	39
Schematic pump package	40
Installation - Mechanical (Water pumps)	41
Integrated Pump Available Pressure	42



Chilled water integrated pump available pressure.....	42
Performance curves.....	43
Pumps available High Head:	47
Performance curves.....	48
Chilled/hot water freeze protection	51
Freeze Protection	51
Freeze protection with glycol.....	52
Using glycol with hydraulic module.....	52
General Electrical Recommendations	54
Electrical Parts.....	54
Electrical data	54
Installer-Supplied Components	55
Power SupplyWiring.....	55
Control Power Supply	55
Heater Power Supply	55
Water Pump Power Supply	55
Interconnecting Wiring.....	55
Alarm and Status Relay Outputs(Programmable Relays)	55
Supplemental heat option.....	56
Operating Principles	57
Arbitration Rules	57
CMAF refrigerant schematic.....	58
Operating Maps	60
CMAF Operating Maps	60
Controls/Tracer TD7 Operator Interface.....	62

Controls Overview 62

TracerTD7 Operator Interface..... 62

Tracer™TU 62

Tracer™TU Set-Up..... 62

Pre-Start Checkout 63

Installation Checklist 63

General 63

Unit Voltage Power Supply 63

Unit Voltage Imbalance 63

Unit Voltage Phasing 63

Unit Start Up Procedures 65

Daily Unit Start Up 65

General 65

Seasonal Unit Startup Procedure 65

System Restart after ExtendedShutdown 65

Temporary Shutdown and Restart..... 66

Extended Shutdown Procedure 66

Periodic Maintenance 67

General 67

Monthly Maintenance 68

Annual Maintenance..... 68

Refrigerant Emission Control 68

Refrigerant and Oil-chargeManagement..... 69

Compressor Service Information 70

Compressor Electrical Connections 70

Oil Level 70



Oil Fill, Removal and Capacity	70
Oil Testing	70
Oil Equalizer Line.....	70
Tandem and Trio Compressor Suction Restrictors	70
Compressor Replacement.....	70
Refrigerant System Open Time.....	70
Mechanical Compressor Failure	71
Electrical Compressor Failure	71
Compressor Motor Megging	71
Compressor Current Imbalance	71
Compressor Electrical Terminal Box	71
Compressor Crankcase Heaters.....	71
Refrigerant Piping.....	71
Integrated Pump Maintenance	72
Water Pump Maintenance	72
Lubrication	72
Exchanger Maintenance	73
Coil Condenser Maintenance	73
BPHE Maintenance.....	73
BPHE replacement	73
Log Check Sheet.....	74
Recommended service routine frequencies	75
Additional services	76
Oil analysis.....	76
Vibration analysis.....	76



System upgrade..... 76

Water treatment 76

Refrigerant analysis..... 76

Annual cooling tower maintenance 76

24 hours duty 76

Trane Select Agreements..... 76

5 years motor-compressor warranty..... 76

Energy enhancement 76

General Information

Foreword

These instructions are given as a guide to good practice in the installation, start-up, operation, and maintenance by the user of Trane CMAF multi-pipe units.

A separate manual is available for the use and maintenance of the unit's controller. They do not contain full-service procedures necessary for the continued successful operation of this equipment. The services of a qualified technician should be employed through the medium of a maintenance contract with a reputable service company. Read this manual thoroughly before unit start-up.

Note: All units are assembled, pressure tested, dehydrated, charged and tested in accordance with factory standard before shipment.

Warnings and Cautions

Warnings and Cautions appear at appropriate sections throughout this manual. Your personal safety and the proper operation of this machine require that you follow them carefully. The constructor assumes no liability for installations or servicing performed by unqualified personnel.

WARNING: Indicates a potentially hazardous situation which, if not avoided, could result in death or serious injury.

CAUTION: Indicates a potentially hazardous situation which, if not avoided, may result in minor or moderate injury. It may also be used to alert against unsafe practices or for equipment or property-damage-only accidents.

Safety Recommendations

To avoid death, injury, equipment or property damage, the following recommendations should be observed during maintenance and service visits:

1. The maximum allowable pressures for system leak testing on low- and high- pressure side are given in the chapter "Installation". Ensure that the pressures are within the specified limits by using appropriate devices.
2. Disconnect all power supplies before the start of any service activity on the unit.
3. Service work on the refrigeration system and the electrical system should be carried out only by qualified and experienced personnel.
4. To avoid any risk, it is recommended to place the unit on an area with limited access.

The following pictograms can be found on the unit. Take necessary precautions to avoid damage and injury.

Figure 1 - Warning pictograms



- 1 = Risk that unit is powered up
- 2 = Risk hazard due to fan rotation
- 3 = Risk hazard of burns on compressors or refrigeration piping
- 4 = Unit contains refrigerant gas. See specific warnings.
- 5 = Risk of residual voltage when speed drive, capacitor or soft-starter options are present
- 6 = Unit under pressure
- 7 = Risk to cut, particularly on heat exchanger fins
- 8 = Read instructions before installation
- 9 = Disconnect all electric power before servicing
- 10 = Read technical instructions

Reception

On arrival,

- Inspect the unit before signing the delivery note.
- Specify any visible damage on the delivery note.
- Notify the local TRANE sales office at the same time.

Note: The delivery note must be clearly signed after inspection and countersigned by the driver.

Also send a registered letter of protest to the last carrier of the goods within 7 days of delivery.

Concealed damage also shall be notified by a registered letter of protest to the last carrier of the goods within 7 days of delivery. Notify the local TRANE sales office at the same time.

Important notice: No shipping claims will be accepted by TRANE if the above-mentioned procedure is not respected.

For more information, refer to the general sales conditions of your local TRANE sales office.

Note: For unit's delivered in France, scheduled time for unit inspection and notifying through registered letter in case of visible and concealed damage is only 72 hours.

Loose Parts Inventory

Check all the accessories and loose parts that are shipped with the unit against the shipping list. Included in these items will be the water vessel drain plugs, rigging and electrical diagrams, service literature, which are placed inside the control panel and/or starterpanel for shipment. If optional elastomeric isolators are ordered with the unit, they are shipped mounted on the horizontal support frame of the unit. The isolators' location and distribution weight diagram are placed with the service literature inside the starter/ control panel.

Warranty

Warranty is based on the general terms and conditions of the manufacturer. The warranty is void if the equipment is repaired or modified without the written approval of the manufacturer if the operating limits are exceeded or if the control system or the electrical wiring is modified. Damage due to misuse, lack of maintenance or failure to comply with the manufacturer's instructions or recommendations is not covered by the warranty obligation. If the user does not conform to the rules of this manual, it may entail cancellation of warranty and liabilities by the manufacturer.

Startup **MUST** be performed by Trane, or an authorized agent of Trane, to **VALIDATE** this **WARRANTY**.

Maintenance contract

It is strongly recommended that you sign a maintenance contract with your local Service Agency.

This contract provides regular maintenance of your installation by a specialist in our equipment. Regular maintenance ensures that any malfunction is detected and corrected in good time and minimizes the possibility that serious damage will occur. Finally, regular maintenance ensures the maximum operating life of your equipment. We would remind you that failure to respect these installation and maintenance instructions may result in immediate cancellation of the warranty.

Training

To assist you in obtaining the best use of it and maintaining it in perfect operating condition over a long period of time, the manufacturer has at your disposal

a refrigeration and air conditioning service school. The principal aim of this is to give operators and technicians a better knowledge of the equipment they are using,

or that is under their charge. Emphasis is particularly given to the importance of periodic checks on the unit operating parameters as well as on preventive

maintenance, which reduces the cost of owning the unit by avoiding serious and costly breakdown.

Refrigerant

The refrigerant provided by the manufacturer meets all the requirements of our units. When using recycled or reprocessed refrigerant, it is advisable to ensure its quality is equivalent to that of a new refrigerant. For this, it is necessary to have a precise analysis made by a specialized laboratory. If this condition is not respected, the manufacturer warranty could be cancelled.



Unit Description

Multi-Pipe CMAF is an Air-to-Water scroll compressor unit designed for outdoor installation. The unit can work in different operating modes as below:

1. Heat recovery Mode (Simultaneous Cooling + Heating)
2. Cooling Mode
3. Heat Pump Mode

The units have two independent refrigerant circuits, two compressors per circuit. Units are designed with a brazed plate exchanger for both chilled/hot water exchanger and a fin and tube coil exchanger which work as air evaporator/ condenser

Each unit is completely assembled, hermetic packaged, refrigerant circuit factory piped, electrical components wired, leak tested, dehydrated, charged, and tested.

The water inlets and outlets openings are covered for shipment.

Units feature Trane's exclusive Tracer Symbio™ 800 Control logic and controls. It monitors the control variables that govern the operation of the unit. Control logic can correct these variables, when necessary, to optimize operational efficiencies, avoid unit shut down, and keep producing chilled or hot water.

These units come with various options and can be customized depending on capacity, efficiencies, acoustic levels, applications requirements at the time of order placement.

Unit received and its options can be cross-checked with the serial and model number provided in unit nameplate and description provided under unit model number description provided in manual.

Nameplates

The nameplates are applied to the exterior of the control panel. A compressor nameplate is located on each compressor.

Unit Nameplate

The unit nameplate provides:

- Unit model and size description
- Unit serial number
- Unit electrical requirements
- Operating charges of refrigerant and refrigerant oil
- Unit service pressures

Compressor Nameplate

The compressor nameplate provides:

- Compressor model number.
- Compressor serial number.
- Compressor electrical characteristics.
- Utilization range.
- Refrigerant type(s).
- Oil type.

Unit model number description

Digit 1, 2, 3, 4 - Unit Model

CMAF = Air-to-water Multi-pipe Scroll Unit

Digit 5-6-7 - Unit Nominal Tonnage

040 = 40 t
 045 = 45 t
 050 = 50 t
 055 = 55t
 060 = 60 t
 065 = 65 t
 070 = 70 t
 075 = 75 t
 085 = 85 t
 095 = 95 t
 105 = 105 t

Digit 8 - Unit voltage

D = 400V/50Hz/3ph
 G = 400V/50Hz/3ph Compatible with IT Neutral

Digit 9 - Manufacturing Location

I = Bari, Italy (TRANE)
 T = Bari, Italy (ICS)

Digit 10, 11 - Design sequence

* = Major Design Sequence
 A = Major Design Sequence

Digit 12 - Efficiency

N = Standard Efficiency
 H = High Efficiency

Digit 13 - Agency listing

C = CE Certification (Europe)
 U = UKCA mark (UK, excl Northern Ireland)

Digit 14 - Not Used

Digit 15 - Acoustic level

X = Standard noise
 L = Low noise
 E = Extra low noise

Digit 16 - Unit Application

L = Low Ambient Air (CM -20°C/+52°C; HM -18°C/+35°C)

Digit 17 - Relief valve option

W = Without

Digit 18 - Water connection

X = Standard grooved pipe connection
 W = Grooved pipe + welded coupling

Digit 19 - Evaporator Application

N = Standard cooling (4.5°C up to + 20°C)

Digit 20 - Evaporator Configuration

B = Brazed plate heat exchanger

Digit 21 - Thermal Insulation

N = Standard thermal insulation (10 mm)
 D = Double thermal insulation on BPHE (20 mm)

Digit 22 - Condenser Coating

B = Hydrophilic (blue) Coated Fin
 E = Epoxy Coated Aluminum Fin

Digit 23 - Heat Recovery

X = Without

Digit 24 - Hydraulic module

X = Pump signal On/Off
 1 = Dual pump standard pressure
 2 = Single pump standard pressure
 3 = Dual pump high pressure
 4 = Single pump high pressure

Digit 25 - Free Cooling

X = Without

Digit 26 - Power line type connection

B = Disconnect switch

Digit 27 - Control Panel Accessories

X = Without
 1 = Under/Over Voltage Protection
 2 = Under/Over Voltage Protection with ground fault protection

Digit 28 - Human Interface language

C = Spanish
 D = German
 E = English
 F = French
 H = Dutch
 I = Italian
 M = Swedish
 P = Polish
 R = Russian
 T = Czech
 U = Greek
 V = Portuguese
 2 = Romanian
 6 = Hungarian
 8 = Turkish

Digit 29 - Remote Interface

X = Without
 B = BACnet MS/TP interface
 M = Modbus RTU interface
 L = L-LonTalk interface
 C = BACnet TCP/IP interface
 N = ModBusTCP Interface

Digit 30 - External Control Package

X = Without
 A = External set point and Capacity outputs

Digit 31 - Flow switch

2 = Mechanical flow switch, to be installed on the job site by the contractor

Digit 32 - Electrical Panel Protection

1 = Enclosure with IP 20 internal protection

Digit 33 - Master Slave

X = Without
 A = With

Digit 34 - Human Interface

L = Standard, Local UI supplied

Digit 35 - Energy meter

X = Without
 M = With

Digit 36 - Not used

Digit 37 - Chilled Loop Primary Flow Control

X = Constant speed pump (no VFD)
 F = Constant speed pump with VFD adjustment on each pump

Digit 38 - Refrigerant Loss alarm

X = Without
 V = With

Digit 39 - Web server

X = Without

Digit 40 - Power socket

X = Without
 P = With (230V - 100W)



Digit 41 - Factory tests

X = Without
B=Visual Inspection with customer

Digit 42 - Unit isolation

X = Without
1 = Rubber Isolators
6 = Spring Isolators

Digit 43 - Literature language

B = Bulgarian
C = Spanish
D = German
E = English
F = French
H = Dutch
I = Italian
K = Finnish
L = Danish
M = Swedish
N = Norwegian
P = Polish
R = Russian
T = Czech
U = Greek
V = Portuguese
Z = Slovene
2 = Romanian
3 = Serbian
4 = Slovak
5 = Croatian
6 = Hungarian
8 =Turkish

Digit 44 - Shipping package

X = Standard protection
A = Unit containerization package

Digit 45 - Refrigerant

X = Without
B= R454B Factory Refrigerant Charge

Digit 46 - Isolator Valve per Manifold Compressor

A = With (Discharge and Liquid)

Digit 47 - Power Factor Correction Capacitors

X = Without
A = With

Digit 48 - Not Used

Digit 49 - Freeze Protection (Factory Installed)

X = Without
2 = With

Digit 50 - Evaporator Buffer Tank

X = Without

Digit 51 - Evaporator Water Strainer

X = Without
B = With (loose accessory to be mounted on job site)

Digit 52 - Appearance Options

X = Without
B = Complete anti-intrusion grilles
C = Condensing coil protection grilles

Digit 53 - Staged Auxiliary heater

X = Without
1 = With Auxiliary heater relays

Digit 54 - Starter type

A = Across the line starter/Direct in Line
B = Soft starter

Digit 55 - Annunciation Relay

X = Without
A = With

Digit 56 - Fan type

1 = AC fan
3 = EC for HESP up to 80 Pa
4 = AC with phase cut modulation

Digit 57 - Night Noise Setback (NNSB)

X = Without
1 = With (With EC fans only)

Digit 58 - Not Used

Digit 59 - Hot Loop Hydraulic Module

X = Signal On/Off Pump
2 = Single Pump Standard Pressure
4 = Single Pump High Pressure
1 = Dual Pump standard pressure, alternate running
3 = Dual Pump high pressure, alternate running
5 = Dual Pump standard pressure, simultaneous running
6 = Dual Pump high pressure, simultaneous running
A = Single pump standard pressure, 5K delta T
B = Single pump high pressure, 5K delta T
C = Dual pump standard pressure, alternate running, 5K delta T
D = Dual pump high pressure, alternate running, 5K delta T

Digit 60 - Hot Loop Primary flow control

X = Without VFD
F = Constant speed pump_VFD Adjustment

Digit 61 - Hot Loop water strainer

X = Without
B = With (loose accessory to be mounted on job site)

Digit 62 - Not Used

Digit 63 - Not Used

Digit 64 - Not Used

Digit 65 - Special

X = Standard catalog
S = Special Requirement

Pre-Installation

Inspection checklist

When the unit is delivered, verify that it is the correct unit and that it is properly equipped. Compare the information which appears on the unit nameplate with the ordering and submittal information.

Inspect all exterior components for visible damage. Report any apparent damage or material shortage to the carrier and make a “unit damage” notation on the carrier’s delivery receipt. Specify the extent and type of damage found and notify the appropriate Trane Sales Office. Do not proceed with installation of a damaged unit without sales office approval.

Mandatory Start-up Checklist

This checklist is not intended to be a substitution for the contractor’s installation instruction. This checklist is intended to be a guide for the Trane technician just prior to unit ‘start-up’. Many of the recommended checks and actions could expose the technician to electrical and mechanical hazards. Refer to the appropriate sections in the unit manual for appropriate procedures, component specifications and safety instructions.

Except where noted; it is implied that the technician is to use this checklist for inspection / verification of prior task completed by the general contractor at installation.

1. Unit clearances adequate for service and to avoid air recirculation, etc
2. Unit exterior inspected. Condenser coils shall not be obstructed at any time by snow or ice during winter conditions
3. Unit properly grounded
4. Crankcase heaters working for 24 hours prior to arrival of Trane technician performing start up
5. Correct voltage supplied to unit and electric heaters (imbalance not to exceed 2%)
6. Unit power phasing (A-B-C sequence) proper for compressor rotation
7. Copper power wiring meets sizing requirement in job submittal
8. All automation and remote controls installed/ wired
9. All wiring connections tight
10. Prove chilled water side Interlock and Interconnecting
11. Wiring Interlock and externals (chilled water pump)
12. Field installed control wiring landed on correct terminals (external start/stop, emergency stop, chilled water reset...)
13. Verify all refrigerant and oil valves are open/back seated
14. Compressor oil levels (1/2 -3/4 high in glass) proper
15. Verify chilled water strainer is clean and free of debris and chilled/hot water circuits are filled
16. A pressure switch device to detect lack of water is not included in the pump package. Installation of this type of device is highly recommended to avoid sealing damage due to operation of pump without enough water
17. Close the fused-disconnect switches that supplies power to the chilled water pump starter
18. Start the chilled water pump to begin circulation of the water. Inspect piping for leaks and repair as necessary. Check the physical presence of the waterpressure switch
19. With water circulating through the system, adjust water flow and check water pressure drop through Chilled/Hot Water Exchanger.
20. Return water pumps to auto
21. Verify all the unit controller Menu Items
22. All panels/doors secured prior to start-up
23. All coil fins inspected and straightened
24. Rotate fans before starting unit to inspect for potential audible and visual signs of rubbing. Start unit
25. Press AUTO key. The unit will start if the unit control calls for cooling or heating and the safety interlocks are closed
26. Check the suction and discharge refrigerant pressure on the unit controller
27. Confirm Superheat and sub-cooling values are normal
28. Compressor operation normal and within amperage rating
29. Operating log completed
30. Press stop key
31. Inspect fans again after being under load to ensure no signs or rubbing exist
32. Verify the water pumps run for at least 1 minute (possibility to configure maxi 10 mn) after the unit is commanded to stop (for normal chilled water systems)

Unit storage

If the unit is to be stored for more than one month prior to installation, observe the following precautions:

- Store the unit in a secured area, to avoid intentional damages.
- Close the suction, discharge and liquid-line isolation valves.
- Store the unit in a dry, vibration-free, secure area.
- At least every three months, attach a gauge and manually check the pressure in the refrigerant circuit.
- If the refrigerant pressure is below 13 bar at 20°C (or 10 bar at 10°C), call a qualified service organization and the appropriate Trane sales office.

Note: If the unit is stored before servicing near a construction site it is highly recommended to protect coils from any concrete and iron element. Failure to do so may considerably reduce reliability of the unit.



Installation requirements and contractor responsibilities

A list of the contractor responsibilities typically associated with the unit installation process is provided.

Type of requirement	Trane-supplied Trane-installed	Trane-supplied Field-installed	Field-supplied Field-installed
Foundation			<ul style="list-style-type: none"> • Meet foundation requirements
Rigging			<ul style="list-style-type: none"> • Safety chains • Clevis connectors • Lifting beams
Isolation		<ul style="list-style-type: none"> • Rubber Isolators • Spring Isolator 	<ul style="list-style-type: none"> • Isolators (Customer Supplied)
Electrical	<ul style="list-style-type: none"> • Disconnect Switch • Unit mounted starter 		<ul style="list-style-type: none"> • Wiring sizes per submittals and local codes and regulations • Terminal lugs • Ground connection(s) • BAS Wiring (optional) • Control voltage wiring • Chilled water pump contactor and wiring including interlock • Option relays and wiring • Optional supplemental heaters
Water piping	<ul style="list-style-type: none"> • Flow Switch • Water Strainer (Optional) 		<ul style="list-style-type: none"> • Taps for thermometers and gauges • Thermometers • Water flow pressure gauges • Isolation and balancing valves in water piping • Vents and drains • Pressure relief valves • Pressure switch device to detect lack of water
Insulation	<ul style="list-style-type: none"> • Insulation 		<ul style="list-style-type: none"> • Insulation (Piping)
Water piping connection elements	<ul style="list-style-type: none"> • Grooved pipe 	<ul style="list-style-type: none"> • Grooved pipe couplings (or) Flanged Adapters 	

General Data

Table 1 - General data CMAF 040-045-050-055-065 SE (Standard Efficiency)

Unit size		040	045	050	055	065
Total cooling capacity (1)	kW	139	151	162	197	226
Total heating capacity (1)	kW	178	193	208	251	288
Total power Input (1)	kW	39	42	46	54	63
Unit Electrical Data (2) (3) (4)						
Short Circuit Unit Capacity (9)	kA	15	15	15	15	15
Power Cable Cross Section (max)	mm ²	1*240	1*240	1*240	1*240	1*240
Disconnect switch size	A	400	400	400	400	400
Digit 56=1 AC fan						
Max Power Input per Motor	kW	60.3	65.8	71.2	82.4	87.9
Max Amps per Motor	A	130.5	140.8	151.0	166.5	182.0
Unit start up amps (w/o soft starter - Digit 54=A) (4)	A	268.2	314.4	321.6	366.1	380.7
Unit start up amps (with soft starter - Digit 54=B) (4)	A	187.7	220.1	225.1	256.3	266.5
Displacement power factor (dpf)	-	0.83	0.83	0.83	0.83	0.83
Compressors						
Manifold Tonnage (Ton) Circuit 1 and 2		25+25T	25+30T	30+30T	30+40T	40+40T
Max Comp Power input Circuit 1 / Circuit 2	kW	25,6/29	32,8/27,3	32,8/32,8	25,6/31	44/44
Rated Amps Circuit 1 / Circuit 2 (4)	A	43,5/43,5	48,6/56,3	48,6/56,3	84,8/36	72/72
Start Amps Circuit 1 / Circuit 2 (Digit 54=A) (4)	A	174/188	174/230	230/230	230/268	271/271
Start Amps Circuit 1 / Circuit 2 (Digit 54=B) (4)	A	122/132	122/161	161/161	161/188	190/190
Locked Rotor Amps Circuit 1 / Circuit 2 (4)	A	147+147/	147+147/	197+197/	197+197/	227+227/
		158+158	158+197	197+197	227+227	227+227
Motor speed	rpm	2900	2900	2900	2900	2900
Oil sump heater Circuit 1 / Circuit 2	W	180/180	180/180	180/180	180/180	180/180
Number of refrigerant circuits	-	2	2	2	2	2
Number of part load steps	-	8	11	4	8	4
Minimum capacity step	%	24	27	25	29	25
Dual Circuit Chilled Water Exchanger						
Brazed Plate Heat Exchanger Materials (model)	-	Stainless steel/copper				
Plate number	-	130	130	130	202	202
Water Content	l	25.0	27.1	29.2	33.7	38.0
Nominal water connection size	in.	3	3	3	3	4
(Grooved coupling) - With or without HYM	mm	114,3	114,3	114,3	114,3	114,3
Water Pressure Drop (1)	kPa	19.0	22.3	25.8	22.7	28.9
Dual Circuit Hot Water exchanger						
Brazed Plate Heat Exchanger Materials (model)	-	Stainless steel/copper				
Plate number	-	202	202	202	250	250
Water Content	l	24.1	25.9	27.7	32.5	36.4
Nominal water connection size	in.	3	3	3	3	4
(Grooved coupling) - With or without HYM	mm	114,3	114,3	114,3	114,3	114,3
Water Pressure Drop (1)	kPa	32.6	37.6	42.8	25.0	31.2



Condenser Module						
Coils						
Type	-	Aluminum/copper fin and tube				
Total Quantity	-	4	4	4	4	4
Face area per circuit	m ²	4.7	4.7	4.7	4.7	4.7
Fans						
Type	-	AC + PCM				
Number of fans	-	4	4	4	4	4
Air flow (1), cooling mode	m ³ /h	72,827	72,663	72,585	71,973	71,972
Air flow (2), heating/ heat pump mode	m ³ /h	78,400	78,153	77,851	77,348	77,350
Digit 56=1 AC fan						
Max Power Input per Motor	kW	1.4	1.4	1.4	1.4	1.4
Max Amps per Motor	A	2.8	2.8	2.8	2.8	2.8
Motor RPM (Cooling mode)	rpm	870	870	870	870	870
Chilled Water Pump Package options						
Single pump - Standard head pressure (digit 24=2)						
Available Head Pressure (1)	kPa	202	271	201	225	214
Motor Power	kW	3.44	6.09	4.52	3.44	3.44
Rated Amps	A	6.4	10.6	8.7	6.4	6.4
Single pump - High head pressure (digit 24=4)						
Available Head Pressure (1)	kPa	281	337	323	305	294
Motor Power	kW	4.52	8.26	8.26	4.52	4.52
Rated Amps	A	8.7	13.6	13.6	8.7	8.7
Dual pump - Standard head pressure (digit 24=1)						
Available Head Pressure (1)	kPa	202	271	201	225	214
Motor Power	kW	3.44	6.09	4.52	3.44	3.44
Rated Amps	A	6.4	10.6	8.7	6.4	6.4
Dual pump - High head pressure (digit 24=3)						
Available Head Pressure (1)	kPa	281	337	323	305	294
Motor Power	kW	4.52	8.26	8.26	4.52	4.52
Rated Amps	A	8.7	13.6	13.6	8.7	8.7
Hot Water Pump Package Options						
Single pump - Standard head pressure (digit 59=2)						
Available Head Pressure (5)	kPa	229	223	219	229	220
Motor Power	kW	2.55	2.55	2.55	1.77	1.77
Rated Amps	A	4.7	4.7	4.7	3.3	3.3
Single pump - High head pressure (digit 59=4)						
Available Head Pressure (5)	kPa	354	347	343	306	298
Motor Power	kW	4.52	4.52	4.52	2.55	2.55
Rated Amps	A	8.7	8.7	8.7	4.7	4.7
Dual pump- Alternate running - Standard head pressure (digit 59=1)						
Available Head Pressure (5)	kPa	229	223	219	229	220
Motor Power	kW	2.55	2.55	2.55	1.77	1.77
Rated Amps	A	4.7	4.7	4.7	3.3	3.3
Dual pump - Alternate running - High head pressure (digit 59=3)						



Available Head Pressure (5)	kPa	354	347	343	306	298
Motor Power	kW	4.52	4.52	4.52	2.55	2.55
Rated Amps	A	8.7	8.7	8.7	4.7	4.7
Dual pump - Simultaneous running - Standard head pressure (digit 59=5)						
Available Head Pressure (5)	kPa	212	201	203	215	203
Motor Power	kW	5.1	5.1	5.1	3.54	3.54
Rated Amps	A	9.4	9.4	9.4	6.6	6.6
Dual pump - Simultaneous running - High head pressure (digit 59=6)						
Available Head Pressure (5)	kPa	337	325	327	292	281
Motor Power	kW	9.04	9.04	9.04	5.1	5.1
Rated Amps	A	17.4	17.4	17.4	9.4	9.4
Single pump - Standard head pressure (digit 59 = A)						
Available Head Pressure (1)	kPa	199	270	216	236	225
Motor Power	kW	3.44	6.09	4.52	3.44	3.44
Rated Amps	A	6.4	10.6	8.7	6.4	6.4
Single pump - High head pressure (digit 59 = B)						
Available Head Pressure (1)	kPa	279	337	337	315	305
Motor Power	kW	4.52	8.26	8.26	4.52	4.52
Rated Amps	A	8.7	13.6	13.6	8.7	8.7
Dual pump - Alternate running - Standard head pressure (digit 59 = C)						
Available Head Pressure (1)	kPa	199	270	216	236	225
Motor Power	kW	3.44	6.09	4.52	3.44	3.44
Rated Amps	A	6.4	10.6	8.7	6.4	6.4
Dual pump - Alternate running -High head pressure (digit 59 = D)						
Available Head Pressure (1)	kPa	279	337	337	315	305
Motor Power	kW	4.52	8.26	8.26	4.52	4.52
Rated Amps	A	8.7	13.6	13.6	8.7	8.7
Antifreeze protection option						
Without any Water Pump Package						
WITH DIGIT 24_X and/or DIGIT 59_X	kW	0.36	0.36	0.36	0.36	0.36
Combinations without Hot Water Pump Package						
WITH DIGIT 24_2 and 24_4(B1_A1)	kW	0.76	0.76	0.76	0.76	0.76
	kW	0.76	0.76	0.76	0.76	0.76
Combinations with Hot water Package						
WITH DIGIT 59_2 and 59_4 and 59_A and 59_B (L1 H1)	kW	0.76	0.76	0.76	0.76	0.76
WITH DIGIT 59_1 and 59_3 and 59_C and 59_D (L2 H2)	kW	0.76	0.76	0.76	0.76	0.76
Dimensions and weight (basic model only)						
Length	mm	2505	2505	2505	2505	2505
Width	mm	1997	1997	1997	1997	1997
Height	mm	2412	2412	2412	2412	2412
Pump Package Option - (Additional length)	mm	555	555	555	555	555
Weights						
Operating Weight	kg	1631	1707	2115	1631	1707
Additional Shipping Weight	kg	1612	1689	2092	1612	1689
Additional Weight of options						



Chilled water pump						
Single pump - Standard head pressure	kg	254	254	254	254	254
Single pump - High head pressure	kg	301	301	301	301	301
Twin pump - Standard head pressure	kg	343	343	343	343	343
Twin pump - High head pressure	kg	425	425	425	425	425
Hot water pump						
Single pump - Standard head pressure	kg	145	145	145	145	145
Single pump - High head pressure	kg	187	187	187	187	187
Double pump - Standard head pressure	kg	225	225	225	225	225
Double pump - High head pressure	kg	307	307	307	307	307
Extra Low Noise (XLN) Option	kg	115	115	115	115	115
Optional Pump VFD	kg	85	85	85	85	85
Optional Chilled Water Buffer tank	kg	253	253	253	253	253
Oil and Refrigerant Charge (R454B)						
Total Refrigerant charge (6)	kg	45	45	45	45	45
Refrigerant Charge per cooling kW (6)	kg/kW	0.33	0.31	0.29	0.25	0.22
POE Oil Type		OIL058E/OIL057E				
Oil charge Circuit 1 / 2 (6)	l	14,8/14,8	14,8/14,8	14,8/14,8	14,8/14,8	14,8/14,8

- (1) Indicative performance at chilled water exchanger water temperature : 12°C / 7°C and air temperature 35°C for cooling only mode & hot water exchanger temperature: 40°C / 45°C and air temperature 7°C (6°C) for heating only mode for- detailed performances, on a given unit, consult Order Write Up.
- (2) Under 400V/3/50Hz.
- (3) Rated Condition without Pump Package.
- (4) Electrical system data are indicative and subject to change without notice. Please refer to unit nameplate data.
- (5) Hot water exchanger temperature 40°C / 50°C and air temperature 7°C (6°C) for heating only mode.
- (6) Refrigerant and oil charges are indicative. Refer to unit nameplate for real charges.

Table 2 - General data CMAF 070-075-085-095-105 SE (Standard Efficiency)

Unit size		070	075	085	095	105
Total cooling capacity (1)	kW	241	252	274	311	338
Total heating capacity (1)	kW	306	320	348	395	433
Total power Input (1)	kW	65	69	75	85	96
Unit Electrical Data (2) (3) (4)						
Short Circuit Unit Capacity (9)	kA	15	15	15	15	15
Power Cable Cross Section (max)	mm ²	1*240	1*240	1*240	1*240	1*240
Disconnect switch size	A	400	400	400	400	400
Digit 56=1 AC fan						
Max. power input	kW	104.2	108.9	118.3	133.9	149.6
Max. Amps	A	229.9	238.2	254.8	277.9	301.0
Unit start up amps (w/o soft starter - Digit 54=A) (4)	A	459.5	465.7	478.0	532.5	553.0
Unit start up amps (with soft starter - Digit 54=B) (4)	A	297.4	326.0	334.6	372.8	387.1
Displacement power factor (dpf)	-	0.83	0.83	0.84	0.84	0.84
Compressors						
Manifold Tonnage (Ton) Circuit 1 and 2		45+40T	45+45T	50+50T	55+55T	60+60T
Max Comp Power input Circuit 1 / Circuit 2	kW	66/26,7	44,0/22,0	53,4/53,4	53,4/69	69/69
Rated Amps Circuit 1 / Circuit 2 (4)	A	107/36	71,8/88,4	88,4/88,4	88,4/111,5	112/112
Start Amps Circuit 1 / Circuit 2 (Digit 54=A) (4)	A	274/316	274/316	316/316	316/361	361/361
Start Amps Circuit 1 / Circuit 2 (Digit 54=B) (4)	A	190/221	192/221	221/221	221/253	252/252
Locked Rotor Amps Circuit 1 / Circuit 2 (4)	A	227+227/	227+227/	260+260/	260+260/	294+294/
		227+260	260+260	260+260	294+294	294+294
Motor speed	rpm	2900	2900	2900	2900	2900
Oil sump heater Circuit 1 / Circuit 2	W	180/180	180/180	180/180	180/180	180/180
Number or refrigerant circuits	-	2	2	2	2	2
Number of part load steps	-	7	8	4	8	4
Minimum capacity step	%	24	22	25	23	25
Dual Circuit Chilled Water Exchanger						
Brazed Plate Heat Exchanger Materials (model)	-	Stainless steel/copper				
Plate number	-	138	138	138	166	166
Water Content	l	41.0	42.6	45.9	50.9	54.6
Nominal water connection size	poll.	4	4	4	4	4
(Grooved coupling) - With or without HYM	mm	114,3	114,3	114,3	114,3	114,3
Water Pressure Drop (1)	kPa	37.5	23.9	28.0	24.3	39.3
Dual Circuit Hot Water exchanger						
Brazed Plate Heat Exchanger Materials (model)	-	Stainless steel/copper				
Plate number	-	106	106	138	138	138
Water Content	l	41.9	44.6	48.5	53.9	58.7
Nominal water connection size	poll.	4	4	4	4	4
(Grooved coupling) - With or without HYM	mm	114,3	114,3	114,3	114,3	114,3
Water Pressure Drop (1)	kPa	21.4	23.9	28.0	24.3	28.6
Condenser Module						
Coils						
Type	-	Aluminum/copper fin and tube				
Total Quantity	-	6	6	6	6	6
Face area per circuit	m ²	7	7	7	7	7



Fans						
Type	-	AC				
Number of fans	-	6	6	6	6	6
Air flow (1), cooling mode	m3/h	108,674	108,680	108,441	108,128	107,818
Air flow (2), heating/ heat pump mode	m3/h	116,045	116,046	115,908	116,046	116,160
Digit 56 = 1 fan AC						
Max Power Input per Motor	kW	1.4	1.4	1.4	1.4	1.4
Max Amps per Motor	A	2.8	2.8	2.8	2.8	2.8
Motor RPM (Cooling mode)	rpm	870	870	870	870	870
Chilled Water Pump Package options						
Single pump - Standard head pressure (digit 24=2)						
Available Head Pressure (1)	kPa	202	196	184	185	194
Motor Power	kW	3.44	4.52	4.52	4.52	6.09
Rated Amps	A	6.4	8.7	8.7	8.7	10.6
Single pump - High head pressure (digit 24=4)						
Available Head Pressure (1)	kPa	282	317	304	303	292
Motor Power	kW	4.52	8.26	8.26	8.26	10.12
Rated Amps	A	8.7	13.6	13.6	13.6	17.2
Dual pump - Standard head pressure (digit 24=1)						
Available Head Pressure (1)	kPa	202	196	184	185	194
Motor Power	kW	3.44	4.52	4.52	4.52	6.09
Rated Amps	A	6.4	8.7	8.7	8.7	10.6
Dual pump - High head pressure (digit 24=3)						
Available Head Pressure (1)	kPa	282	317	304	303	292
Motor Power	kW	4.52	8.26	8.26	8.26	10.12
Rated Amps	A	8.7	13.6	13.6	13.6	17.2
Hot Water Pump Package Options						
Single pump - Standard head pressure (digit 59=2)						
Available Head Pressure (5)	kPa	210	214	250	242	232
Motor Power	kW	1.77	2.55	3.44	3.44	3.44
Rated Amps	A	3.3	4.7	6.4	6.4	6.4
Single pump - High head pressure (digit 59=4)						
Available Head Pressure (5)	kPa	289	338	330	322	311
Motor Power	kW	2.55	4.52	4.52	4.52	4.52
Rated Amps	A	4.7	8.7	8.7	8.7	8.7
Dual pump- Alternate running - Standard head pressure (digit 59=1)						
Available Head Pressure (5)	kPa	210	214	250	242	232
Motor Power	kW	1.77	2.55	3.44	3.44	3.44
Rated Amps	A	3.3	4.7	6.4	6.4	6.4
Dual pump - Alternate running - High head pressure (digit 59=3)						
Available Head Pressure (5)	kPa	289	338	330	322	311
Motor Power	kW	2.55	4.52	4.52	4.52	4.52
Rated Amps	A	4.7	8.7	8.7	8.7	8.7
Dual pump - Simultaneous running - Standard head pressure (digit 59=5)						
Available Head Pressure (5)	kPa	191	196	229	223	210
Motor Power	kW	3.54	5.1	6.88	6.88	6.88
Rated Amps	A	6.6	9.4	12.8	12.8	12.8



Dual pump - Simultaneous running - High head pressure (digit 59=6)						
Available Head Pressure (5)	kPa	270	320	309	303	290
Motor Power	kW	5.1	9.04	9.04	9.04	9.04
Rated Amps	A	9.4	17.4	17.4	17.4	17.4
Single pump - Standard head pressure (digit 59 = A)						
Available Head Pressure (1)	kPa	214	208	196	188	198
Motor Power	kW	3.44	4.52	4.52	4.52	6.09
Rated Amps	A	6.4	8.7	8.7	8.7	10.6
Single pump - High head pressure (digit 59 = B)						
Available Head Pressure (1)	kPa	293	329	315	305	297
Motor Power	kW	4.52	8.26	8.26	8.26	10.12
Rated Amps	A	8.7	13.6	13.6	13.6	17.2
Dual pump - Alternate running - Standard head pressure (digit 59 = C)						
Available Head Pressure (1)	kPa	214	208	196	188	198
Motor Power	kW	3.44	4.52	4.52	4.52	6.09
Rated Amps	A	6.4	8.7	8.7	8.7	10.6
Dual pump - Alternate running -High head pressure (digit 59 = D)						
Available Head Pressure (1)	kPa	293	329	315	305	297
Motor Power	kW	4.52	8.26	8.26	8.26	10.12
Rated Amps	A	8.7	13.6	13.6	13.6	17.2
Antifreeze protection option						
Without any Water Pump Package						
WITH DIGIT 24_X and/or DIGIT 59_X	kW	0.36	0.36	0.36	0.36	0.36
Combinations without Hot Water Pump Package						
WITH DIGIT 24_2 and 24_4(B1_A1)	kW	0.76	0.76	0.76	0.76	0.76
	kW	0.76	0.76	0.76	0.76	0.76
Combinations with Hot water Package						
WITH DIGIT 59_2 and 59_4 and 59_A and 59_B (L1 H1)	kW	0.76	0.76	0.76	0.76	0.76
WITH DIGIT 59_1 and 59_3 and 59_C and 59_D (L2 H2)	kW	0.76	0.76	0.76	0.76	0.76
Dimensions and weight (basic model only)						
Length	mm	3295	3295	3295	3295	3295
Width	mm	2232	2232	2232	2232	2232
Height	mm	2513	2513	2513	2513	2513
Pump Package Option - (Additional length)	mm	555	555	555	555	555
Weights						
Operating Weight	kg	2115	2122	2132	2275	2376
Additional Shipping Weight	kg	2092	2095	2101	2239	2340
Additional Weight of options						
Chilled water pump						
Single pump - Standard head pressure	kg	254	254	254	254	254
Single pump - High head pressure	kg	301	301	301	301	301
Twin pump - Standard head pressure	kg	343	343	343	343	343
Twin pump - High head pressure	kg	425	425	425	425	425
Hot water pump						
Single pump - Standard head pressure	kg	145	145	145	145	145
Single pump - High head pressure	kg	187	187	187	187	187
Double pump - Standard head pressure	kg	225	225	225	225	225
Double pump - High head pressure	kg	307	307	307	307	307



Extra Low Noise (XLN) Option	kg	115	115	115	115	115
Optional Pump VFD	kg	85	85	85	85	85
Optional Chilled Water Buffer tank	kg	253	253	253	253	253
Oil and Refrigerant Charge (R454B)						
Total Refrigerant charge (6)	kg	60	60	60	60	60
Refrigerant Charge per cooling kW (6)	kg/kW	0.25	0.24	0.22	0.20	0.19
POE Oil Type		OIL058E/OIL057E				
Oil charge Circuit 1 / 2 (6)	l	14,9/14,9	14,8/14,8	14,8/14,8	14,9/14,9	14,8/14,8

- (1) Indicative performance at chilled water exchanger water temperature : 12 °C / 7 °C and air temperature 35 °C for cooling only mode & hot water exchanger temperature: 40 °C / 45 °C and air temperature 7 °C (6 °C) for heating only mode for- detailed performances, on a given unit, consult Order Write Up.
- (2) Under 400V/3/50Hz.
- (3) Rated Condition without Pump Package.
- (4) Electrical system data are indicative and subject to change without notice. Please refer to unit nameplate data.
- (5) Hot water exchanger temperature 40 °C / 50 °C and air temperature 7 °C (6 °C) for heating only mode.
- (6) Refrigerant and oil charges are indicative. Refer to unit nameplate for real charges

Table 3 - General data CMAF 040-045-050-055-065 HE (High Efficiency)

Unit size		040	045	050	055	065
Total cooling capacity (1)	kW	139	151	162	197	226
Total heating capacity (1)	kW	178	193	208	251	288
Total power Input (1)	kW	39	42	46	54	63
Unit Electrical Data (2) (3) (4)						
Short Circuit Unit Capacity (9)	kA	15	15	15	15	15
Power Cable Cross Section (max)	mm ²	1*240	1*240	1*240	1*240	1*240
Disconnect switch size	A	400	400	400	400	400
Digit 56=1 AC fan						
Max Power Input per Motor	kW	N.A.	N.A.	N.A.	N.A.	N.A.
Max Amps per Motor	A	N.A.	N.A.	N.A.	N.A.	N.A.
Unit start up amps (w/o soft starter - Digit 54=A) (4)	A	N.A.	N.A.	N.A.	N.A.	N.A.
Unit start up amps (with soft starter - Digit 54=B) (4)	A	N.A.	N.A.	N.A.	N.A.	N.A.
Displacement power factor (dpf)	-	N.A.	N.A.	N.A.	N.A.	N.A.
Digit 56=3 EC fan HESP						
Max Power Input per Motor	kW	62.0	67.4	72.9	84.0	98.8
Max Amps per Motor	A	103.7	114.0	124.2	139.7	155.2
Unit start up amps (w/o soft starter - Digit 54=A) (4)	A	241.4	287.6	294.8	339.3	353.9
Unit start up amps (with soft starter - Digit 54=B) (4)	A	169.0	201.3	206.3	237.5	247.8
Displacement power factor (dpf)	-	0.83	0.83	0.83	0.83	0.83
Compressors						
Manifold Tonnage (Ton) Circuit 1 and 2		25+25T	25+30T	30+30T	30+40T	40+40T
Max Comp Power input Circuit 1 / Circuit 2	kW	25,6/29	32,8/27,3	32,8/32,8	25,6/31	44/44
Rated Amps Circuit 1 / Circuit 2 (4)	A	43,5/43,5	48,6/56,3	48,6/56,3	84,8/36	72/72
Start Amps Circuit 1 / Circuit 2 (Digit 54=A) (4)	A	174/188	174/230	230/230	230/268	271/271
Start Amps Circuit 1 / Circuit 2 (Digit 54=B) (4)	A	122/132	122/161	161/161	161/188	190/190
Locked Rotor Amps Circuit 1 / Circuit 2 (4)	A	147+147/	147+147/	197+197/	197+197/	227+227/
		158+158	158+197	197+197	227+227	227+227
Motor speed	rpm	2900	2900	2900	2900	2900
Oil sump heater Circuit 1 / Circuit 2	W	180/180	180/180	180/180	180/180	180/180
Number of refrigerant circuits	-	2	2	2	2	2
Number of part load steps	-	8	11	4	8	4
Minimum capacity step	%	24	27	25	29	25
Dual Circuit Chilled Water Exchanger						
Brazed Plate Heat Exchanger Materials (model)	-	Stainless steel/copper				
Plate number	-	130	130	130	202	202
Water Content	l	25.0	27.1	29.2	33.7	38.0
Nominal water connection size	poll.	3	3	3	3	4
(Grooved coupling) - With or without HYM	mm	114,3	114,3	114,3	114,3	114,3
Water Pressure Drop (1)	kPa	19.0	22.3	25.8	22.7	28.9
Dual Circuit Hot Water exchanger						
Brazed Plate Heat Exchanger Materials (model)	-	Stainless steel/copper				
Plate number	-	202	202	202	250	250
Water Content	l	24.1	25.9	27.7	32.5	36.4



Nominal water connection size	poll.	3	3	3	3	4
(Grooved coupling) - With or without HYM	mm	114,3	114,3	114,3	114,3	114,3
Water Pressure Drop (1)	kPa	32.6	37.6	42.8	25.0	31.2
Condenser Module						
Coils						
Type	-	Aluminum/copper fin and tube				
Total Quantity	-	4	4	4	4	4
Face area per circuit	m ²	4.7	4.7	4.7	4.7	4.7
Fans						
Type	-	EC				
Number of fans	-	4	4	4	4	4
Air flow (1), cooling mode	m ³ /h	72,827	72,663	72,585	71,973	71,972
Air flow (2), heating/ heat pump mode	m ³ /h	78,400	78,153	77,851	77,348	77,350
Digit 56=3 EC fan HESP						
Max Power Input per Motor	kW	1.82	1.82	1.82	1.82	1.82
Max Amps per Motor	A	2.9	2.9	2.9	2.9	2.9
Motor RPM (Cooling mode field setting)	rpm	1020	1020	1020	1020	1020
Chilled Water Pump Package options						
Single pump - Standard head pressure (digit 24=2)						
Available Head Pressure (1)	kPa	202	271	201	225	214
Motor Power	kW	3.44	6.09	4.52	3.44	3.44
Rated Amps	A	6.4	10.6	8.7	6.4	6.4
Single pump - High head pressure (digit 24=4)						
Available Head Pressure (1)	kPa	281	337	323	305	294
Motor Power	kW	4.52	8.26	8.26	4.52	4.52
Rated Amps	A	8.7	13.6	13.6	8.7	8.7
Dual pump - Standard head pressure (digit 24=1)						
Available Head Pressure (1)	kPa	202	271	201	225	214
Motor Power	kW	3.44	6.09	4.52	3.44	3.44
Rated Amps	A	6.4	10.6	8.7	6.4	6.4
Dual pump - High head pressure (digit 24=3)						
Available Head Pressure (1)	kPa	281	337	323	305	294
Motor Power	kW	4.52	8.26	8.26	4.52	4.52
Rated Amps	A	8.7	13.6	13.6	8.7	8.7
Hot Water Pump Package Options						
Single pump - Standard head pressure (digit 59=2)						
Available Head Pressure (5)	kPa	229	223	219	229	220
Motor Power	kW	2.55	2.55	2.55	1.77	1.77
Rated Amps	A	4.7	4.7	4.7	3.3	3.3
Single pump - High head pressure (digit 59=4)						
Available Head Pressure (5)	kPa	354	347	343	306	298
Motor Power	kW	4.52	4.52	4.52	2.55	2.55
Rated Amps	A	8.7	8.7	8.7	4.7	4.7
Dual pump- Alternate running - Standard head pressure (digit 59=1)						
Available Head Pressure (5)	kPa	229	223	219	229	220



Motor Power	kW	2.55	2.55	2.55	1.77	1.77
Rated Amps	A	4.7	4.7	4.7	3.3	3.3
Dual pump - Alternate running - High head pressure (digit 59=3)						
Available Head Pressure (5)	kPa	354	347	343	306	298
Motor Power	kW	4.52	4.52	4.52	2.55	2.55
Rated Amps	A	8.7	8.7	8.7	4.7	4.7
Dual pump - Simultaneous running - Standard head pressure (digit 59=5)						
Available Head Pressure (5)	kPa	212	201	203	215	203
Motor Power	kW	5.1	5.1	5.1	3.54	3.54
Rated Amps	A	9.4	9.4	9.4	6.6	6.6
Dual pump - Simultaneous running - High head pressure (digit 59=6)						
Available Head Pressure (5)	kPa	337	325	327	292	281
Motor Power	kW	9.04	9.04	9.04	5.1	5.1
Rated Amps	A	17.4	17.4	17.4	9.4	9.4
Single pump - Standard head pressure (digit 59 = A)						
Available Head Pressure (1)	kPa	199	270	216	236	225
Motor Power	kW	3.44	6.09	4.52	3.44	3.44
Rated Amps	A	6.4	10.6	8.7	6.4	6.4
Single pump - High head pressure (digit 59 = B)						
Available Head Pressure (1)	kPa	279	337	337	315	305
Motor Power	kW	4.52	8.26	8.26	4.52	4.52
Rated Amps	A	8.7	13.6	13.6	8.7	8.7
Dual pump - Alternate running - Standard head pressure (digit 59 = C)						
Available Head Pressure (1)	kPa	199	270	216	236	225
Motor Power	kW	3.44	6.09	4.52	3.44	3.44
Rated Amps	A	6.4	10.6	8.7	6.4	6.4
Dual pump - Alternate running -High head pressure (digit 59 = D)						
Available Head Pressure (1)	kPa	279	337	337	315	305
Motor Power	kW	4.52	8.26	8.26	4.52	4.52
Rated Amps	A	8.7	13.6	13.6	8.7	8.7
Antifreeze protection option						
Without any Water Pump Package						
WITH DIGIT 24_X and/or DIGIT 59_X	kW	0.36	0.36	0.36	0.36	0.36
Combinations without Hot Water Pump Package						
WITH DIGIT 24_2 and 24_4(B1_A1)	kW	0.76	0.76	0.76	0.76	0.76
	kW	0.76	0.76	0.76	0.76	0.76
Combinations with Hot water Package						
WITH DIGIT 59_2 and 59_4 and 59_A and 59_B (L1 H1)	kW	0.76	0.76	0.76	0.76	0.76
WITH DIGIT 59_1 and 59_3 and 59_C and 59_D (L2 H2)	kW	0.76	0.76	0.76	0.76	0.76
Dimensions and weight (basic model only)						
Length	mm	2505	2505	2505	2505	2505
Width	mm	1997	1997	1997	1997	1997
Height	mm	2412	2412	2412	2412	2412
Pump Package Option - (Additional length)	mm	555	555	555	555	555
Weights						



Operating Weight	kg	1631	1707	2115	1631	1707
Additional Shipping Weight	kg	1612	1689	2092	1612	1689
Additional Weight of options						
Chilled water pump						
Single pump - Standard head pressure	kg	254	254	254	254	254
Single pump - High head pressure	kg	301	301	301	301	301
Twin pump - Standard head pressure	kg	343	343	343	343	343
Twin pump - High head pressure	kg	425	425	425	425	425
Hot water pump						
Single pump - Standard head pressure	kg	145	145	145	145	145
Single pump - High head pressure	kg	187	187	187	187	187
Double pump - Standard head pressure	kg	225	225	225	225	225
Double pump - High head pressure	kg	307	307	307	307	307
Extra Low Noise (XLN) Option	kg	115	115	115	115	115
Optional Pump VFD	kg	85	85	85	85	85
Optional Chilled Water Buffer tank	kg	253	253	253	253	253
Oil and Refrigerant Charge (R454B)						
Total Refrigerant charge (6)	kg	45	45	45	45	45
Refrigerant Charge per cooling kW (6)	kg/kW	0.33	0.31	0.29	0.25	0.22
POE Oil Type		OIL058E/OIL057E				
Oil charge Circuit 1 / 2 (6)	l	14,8/14,8	14,8/14,8	14,8/14,8	14,8/14,8	14,8/14,8

- (1) Indicative performance at chilled water exchanger water temperature : 12 °C / 7 °C and air temperature 35 °C for cooling only mode & hot water exchanger temperature: 40 °C / 45 °C and air temperature 7 °C (6 °C) for heating only mode for- detailed performances, on a given unit, consult Order Write Up.
- (2) Under 400V/3/50Hz.
- (3) Rated Condition without Pump Package.
- (4) Electrical system data are indicative and subject to change without notice. Please refer to unit nameplate data.
- (5) Hot water exchanger temperature 40 °C / 50 °C and air temperature 7 °C (6 °C) for heating only mode.
- (6) Refrigerant and oil charges are indicative. Refer to unit nameplate for real charges.

Table 4 - General data CMAF 070-075-085-095-105 HE (High Efficiency)

Unit size		070	075	085	095	105
Total cooling capacity (1)	kW	241	252	274	311	338
Total heating capacity (1)	kW	306	320	348	395	433
Total power Input (1)	kW	65	69	75	85	96
Unit Electrical Data (2) (3) (4)						
Short Circuit Unit Capacity (9)	kA	15	15	15	15	15
Power Cable Cross Section (max)	mm ²	1*240	1*240	1*240	1*240	1*240
Disconnect switch size	A	400	400	400	400	400
Digit 56=3 EC fan HESP						
Max. power input	kW	103.5	108.2	117.6	133.2	148.8
Max. Amps	A	169.3	177.6	194.2	217.3	240.4
Unit start up amps (w/o soft starter - Digit 54=A) (4)	A	398.9	405.1	417.4	471.9	492.4
Unit start up amps (with soft starter - Digit 54=B) (4)	A	297.4	283.6	292.2	330.3	344.7
Displacement power factor (dpf)	-	0.83	0.83	0.83	0.83	0.83
Compressors						
Manifold Tonnage (Ton) Circuit 1 and 2		45+40T	45+45T	50+50T	55+55T	60+60T
Max Comp Power input Circuit 1 / Circuit 2	kW	66/26,7	44,0/22,0	53,4/53,4	53,4/69	69/69
Rated Amps Circuit 1 / Circuit 2 (4)	A	107/36	71,8/88,4	88,4/88,4	88,4/111,5	112/112
Start Amps Circuit 1 / Circuit 2 (Digit 54=A) (4)	A	274/316	274/316	316/316	316/361	361/361
Start Amps Circuit 1 / Circuit 2 (Digit 54=B) (4)	A	190/221	192/221	221/221	221/253	252/252
Locked Rotor Amps Circuit 1 / Circuit 2 (4)	A	227+227/	227+227/	260+260/	260+260/	294+294/
		227+260	260+260	260+260	294+294	294+294
Motor speed	rpm	2900	2900	2900	2900	2900
Oil sump heater Circuit 1 / Circuit 2	W	180/180	180/180	180/180	180/180	180/180
Number or refrigerant circuits	-	2	2	2	2	2
Number of part load steps	-	7	8	4	8	4
Minimum capacity step	%	24	22	25	23	25
Dual Circuit Chilled Water Exchanger						
Brazed Plate Heat Exchanger Materials (model)	-	Stainless steel/copper				
Plate number	-	138	138	138	166	166
Water Content	l	41.0	42.6	45.9	50.9	54.6
Nominal water connection size	poll.	4	4	4	4	4
(Grooved coupling) - With or without HYM	mm	114,3	114,3	114,3	114,3	114,3
Water Pressure Drop (1)	kPa	37.5	23.9	28.0	24.3	39.3
Dual Circuit Hot Water exchanger						
Brazed Plate Heat Exchanger Materials (model)	-	Stainless steel/copper				
Plate number	-	106	106	138	138	138
Water Content	l	41.9	44.6	48.5	53.9	58.7
Nominal water connection size	poll.	4	4	4	4	4
(Grooved coupling) - With or without HYM	mm	114,3	114,3	114,3	114,3	114,3
Water Pressure Drop (1)	kPa	21.4	23.9	28.0	24.3	28.6
Condenser Module						
Coils						
Type	-	Aluminum/copper fin and tube				
Total Quantity	-	6	6	6	6	6
Face area per circuit	m ²	7	7	7	7	7



Fans						
Type	-	EC				
Number of fans	-	6	6	6	6	6
Air flow (1), cooling mode	m3/h	108,674	108,680	108,441	108,128	107,818
Air flow (2), heating/ heat pump mode	m3/h	116,045	116,046	115,908	116,046	116,160
Digit 56=3 EC fan HESP						
Max Power Input per Motor	kW	1.82	1.82	1.82	1.82	1.82
Max Amps per Motor	A	2.9	2.9	2.9	2.9	2.9
Motor RPM (Cooling mode field setting)	rpm	1020	1020	1020	1020	1020
Chilled Water Pump Package options						
Single pump - Standard head pressure (digit 24=2)						
Available Head Pressure (1)	kPa	202	196	184	185	194
Motor Power	kW	3.44	4.52	4.52	4.52	6.09
Rated Amps	A	6.4	8.7	8.7	8.7	10.6
Single pump - High head pressure (digit 24=4)						
Available Head Pressure (1)	kPa	282	317	304	303	292
Motor Power	kW	4.52	8.26	8.26	8.26	10.12
Rated Amps	A	8.7	13.6	13.6	13.6	17.2
Dual pump - Standard head pressure (digit 24=1)						
Available Head Pressure (1)	kPa	202	196	184	185	194
Motor Power	kW	3.44	4.52	4.52	4.52	6.09
Rated Amps	A	6.4	8.7	8.7	8.7	10.6
Dual pump - High head pressure (digit 24=3)						
Available Head Pressure (1)	kPa	282	317	304	303	292
Motor Power	kW	4.52	8.26	8.26	8.26	10.12
Rated Amps	A	8.7	13.6	13.6	13.6	17.2
Hot Water Pump Package Options						
Single pump - Standard head pressure (digit 59=2)						
Available Head Pressure (5)	kPa	210	214	250	242	232
Motor Power	kW	1.77	2.55	3.44	3.44	3.44
Rated Amps	A	3.3	4.7	6.4	6.4	6.4
Single pump - High head pressure (digit 59=4)						
Available Head Pressure (5)	kPa	289	338	330	322	311
Motor Power	kW	2.55	4.52	4.52	4.52	4.52
Rated Amps	A	4.7	8.7	8.7	8.7	8.7
Dual pump- Alternate running - Standard head pressure (digit 59=1)						
Available Head Pressure (5)	kPa	210	214	250	242	232
Motor Power	kW	1.77	2.55	3.44	3.44	3.44
Rated Amps	A	3.3	4.7	6.4	6.4	6.4
Dual pump - Alternate running - High head pressure (digit 59=3)						
Available Head Pressure (5)	kPa	289	338	330	322	311
Motor Power	kW	2.55	4.52	4.52	4.52	4.52
Rated Amps	A	4.7	8.7	8.7	8.7	8.7
Dual pump - Simultaneous running - Standard head pressure (digit 59=5)						
Available Head Pressure (5)	kPa	191	196	229	223	210
Motor Power	kW	3.54	5.1	6.88	6.88	6.88
Rated Amps	A	6.6	9.4	12.8	12.8	12.8



Dual pump - Simultaneous running - High head pressure (digit 59=6)						
Available Head Pressure (5)	kPa	270	320	309	303	290
Motor Power	kW	5.1	9.04	9.04	9.04	9.04
Rated Amps	A	9.4	17.4	17.4	17.4	17.4
Single pump - Standard head pressure (digit 59 = A)						
Available Head Pressure (1)	kPa	214	208	196	188	198
Motor Power	kW	3.44	4.52	4.52	4.52	6.09
Rated Amps	A	6.4	8.7	8.7	8.7	10.6
Single pump - High head pressure (digit 59 = B)						
Available Head Pressure (1)	kPa	293	329	315	305	297
Motor Power	kW	4.52	8.26	8.26	8.26	10.12
Rated Amps	A	8.7	13.6	13.6	13.6	17.2
Dual pump - Alternate running - Standard head pressure (digit 59 = C)						
Available Head Pressure (1)	kPa	214	208	196	188	198
Motor Power	kW	3.44	4.52	4.52	4.52	6.09
Rated Amps	A	6.4	8.7	8.7	8.7	10.6
Dual pump - Alternate running -High head pressure (digit 59 = D)						
Available Head Pressure (1)	kPa	293	329	315	305	297
Motor Power	kW	4.52	8.26	8.26	8.26	10.12
Rated Amps	A	8.7	13.6	13.6	13.6	17.2
Antifreeze protection option						
Without any Water Pump Package						
WITH DIGIT 24_X and/or DIGIT 59_X	kW	0.36	0.36	0.36	0.36	0.36
Combinations without Hot Water Pump Package						
WITH DIGIT 24_2 and 24_4(B1_A1)	kW	0.76	0.76	0.76	0.76	0.76
	kW	0.76	0.76	0.76	0.76	0.76
Combinations with Hot water Package						
WITH DIGIT 59_2 and 59_4 and 59_A and 59_B (L1 H1)	kW	0.76	0.76	0.76	0.76	0.76
WITH DIGIT 59_1 and 59_3 and 59_C and 59_D (L2 H2)	kW	0.76	0.76	0.76	0.76	0.76
Dimensions and weight (basic model only)						
Length	mm	3295	3295	3295	3295	3295
Width	mm	2232	2232	2232	2232	2232
Height	mm	2513	2513	2513	2513	2513
Pump Package Option - (Additional length)	mm	555	555	555	555	555
Weights						
Operating Weight	kg	2115	2122	2132	2275	2376
Additional Shipping Weight	kg	2092	2095	2101	2239	2340
Additional Weight of options						
Chilled water pump						
Single pump - Standard head pressure	kg	254	254	254	254	254
Single pump - High head pressure	kg	301	301	301	301	301
Twin pump - Standard head pressure	kg	343	343	343	343	343
Twin pump - High head pressure	kg	425	425	425	425	425
Hot water pump						
Single pump - Standard head pressure	kg	145	145	145	145	145
Single pump - High head pressure	kg	187	187	187	187	187
Double pump - Standard head pressure	kg	225	225	225	225	225
Double pump - High head pressure	kg	307	307	307	307	307



Extra Low Noise (XLN) Option	kg	115	115	115	115	115
Optional Pump VFD	kg	85	85	85	85	85
Optional Chilled Water Buffer tank	kg	253	253	253	253	253
Oil and Refrigerant Charge (R454B)						
Total Refrigerant charge (6)	kg	60	60	60	60	60
Refrigerant Charge per cooling kW (6)	kg/kW	0.25	0.24	0.22	0.20	0.19
POE Oil Type		OIL058E/OIL057E				
Oil charge Circuit 1 / 2 (6)	l	14,9/14,9	14,8/14,8	14,8/14,8	14,9/14,9	14,8/14,8

- (1) Indicative performance at chilled water exchanger water temperature: 12 °C / 7 °C and air temperature 35 °C for cooling only mode & hot water exchanger temperature: 40 °C / 45 °C and air temperature 7 °C (6 °C) for heating only mode for- detailed performances, on a given unit, consult Order Write Up.
- (2) Under 400V/3/50Hz.
- (3) Rated Condition without Pump Package.
- (4) Electrical system data are indicative and subject to change without notice. Please refer to unit nameplate data.
- (5) Hot water exchanger temperature 40 °C / 50 °C and air temperature 7 °C (6 °C) for heating only mode.
- (6) Refrigerant and oil charges are indicative. Refer to unit nameplate for real charges.

Typical components location

General view

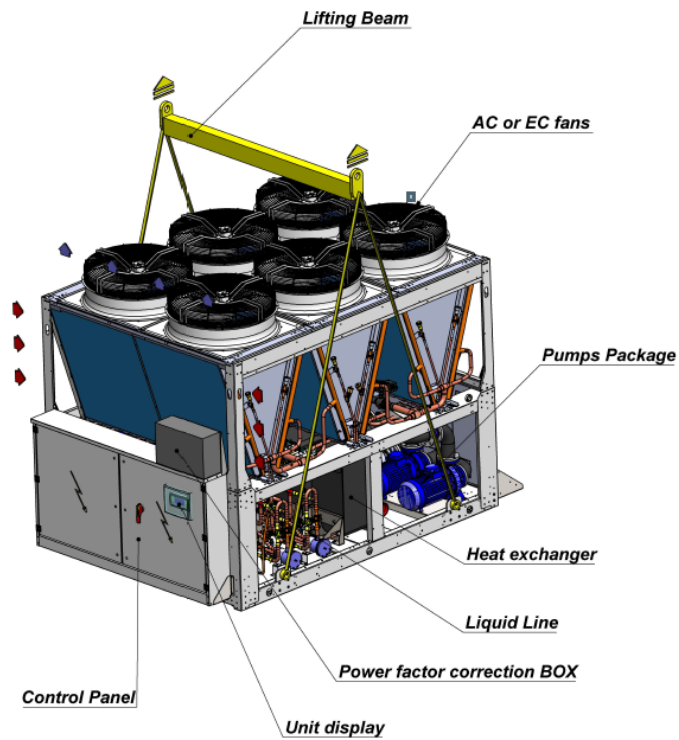

Frontal

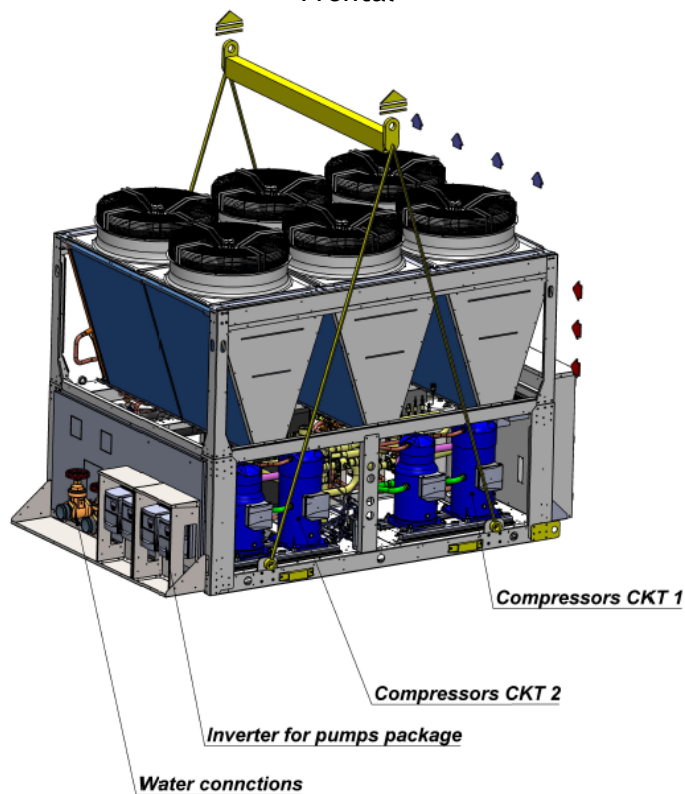

Back

Illustration of Hydraulic module

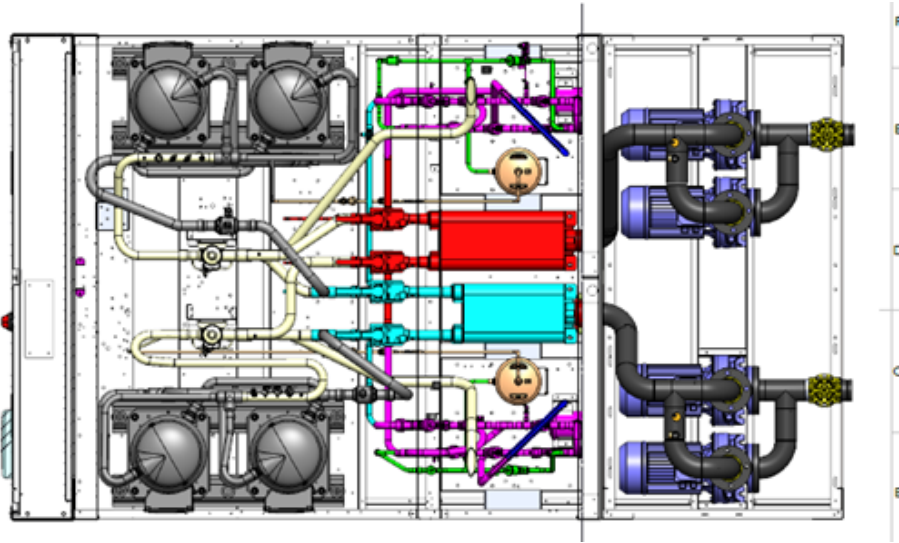

2V models

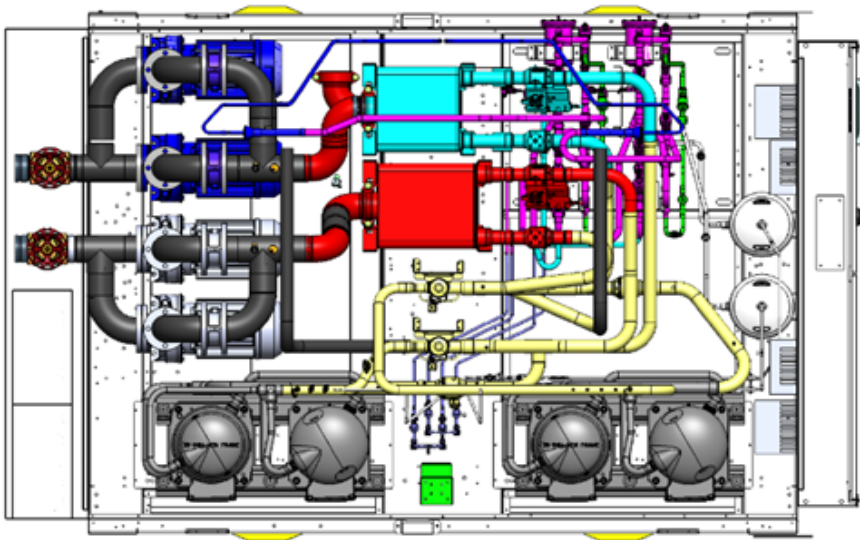

3V models

Installation Requirements

Location Requirements

Sound consideration

The most effective form of acoustical isolation is to locate the unit away from any sound sensitive area.

Structurally transmitted sound can be reduced by elastomeric vibration eliminators. Consult an acoustical engineer in critical sound applications.

For maximum isolation effect, isolate water lines and electrical conduit. Rubber isolated piping hangers can be used to reduce the sound transmitted through water piping. To reduce sound transmitted through electrical conduit, use flexible electrical conduit.

EU and Local Regulations codes on sound emissions should always be considered. Since the environment in which a sound source is located affects the sound pressure, unit placement must be carefully evaluated.

Clearances

When installing the unit, provide enough space around the unit to allow the installation and maintenance personnel unrestricted access to all service points.

Unobstructed flow of condenser air is essential to maintain unit capacity and operating efficiency. When determining unit placement, consider ensuring a sufficient air flow across the condenser coils heat-transfer surface.

In case of enclosure around the unit, the height of the enclosure must not be higher than the unit itself. If the enclosure is higher than the unit, restrictive airflow louvers should be fitted to ensure fresh air supply. Refer to submittal drawings for complementary information.

Installation Responsibilities

Generally, contractor must do the following Items when installing a CMAF Multi-Pipe unit:

1. Install the unit on a flat foundation strong enough to support unit loading and leveling within 5 mm over its length and width.
2. Install the units as per instructions contained in this manual.
3. Where specified, provide and install valves in the water piping upstream and downstream of the water exchanger water connections, to isolate both chilled/hot water exchangers for maintenance, and to balance and trim the system.
4. Furnish and install water pressure gauges in the water inlet and outlet of the Chilled/Hot Water Exchanger.
5. Furnish and install an expansion tank on pump suction of hot water loop when unit is common with heat recovery pump
6. Supply and install an air vent cock to the top of the chilled and hot water loop.
7. Furnish and install strainers ahead of all pumps and automatic modulating valves.
8. Provide and install field wiring according to schematics provided in the control panel.

9. Install heat tape and insulate the chilled water lines and any other portion of the system, as required, to prevent sweating or excessive heat loss under normal operating conditions or freezing during low ambient temperature conditions.
10. Ensure that the compressor and compressor heaters have been operating for a minimum of 24 hours before starting. Failure to do so may result in equipment damage.
11. Start the unit under supervision of a qualified service technician

Lifting and Moving Instructions

A specific lifting method is recommended, which can be described as follow:

1. Lifting points are built into the unit, see lifting instruction label on the unit.
2. Slings and spreader bar must be provided by crane operator and attached on the lifting points.
3. Use the 4 rigging points which are built into the unit.
4. The minimum lifting capacity of each sling as well as the spreader bar must be higher than the tabulated unit shipping weight.

Figure 2 - Typical handling

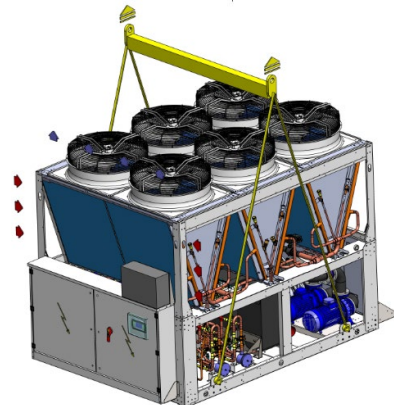

CAUTION! Lift and handle with care. Avoid shocks while handling.

Details of lifting instruction and container pull out are given in the drawings specific for lifting and handling shipped with the unit.

WARNING! Heavy Objects! Ensure that all the lifting equipment used is properly rated for weight of the unit being lifted. Each of the cables (chains or slings), hooks, and shackles used to lift the unit must be capable of supporting the entire weight of unit. Lifting cables (chains or slings) may not be the same length. Adjust as necessary for even unit lift. Other lifting arrangements could cause equipment or property damage. Failure to follow instructions above or properly lift unit could



result in unit dropping and possibly crushing operator/ technician which could result in death or serious injury.

WARNING! Improper Unit Lift! Test lift unit approximately 10 cm to verify proper center of gravity lift point. To avoid dropping of unit, reposition lifting point if unit is not level. Failure to properly lift unit could result in unit dropping and possibly crushing operator/ technician which could result in death or serious injury and possible equipment or property- only damage.

Dimension and Weights

Dimensions details, dimensions of hydraulic connections, electrical connections, isolator positioning, specific features for heat recovery and free cooling are included in submittals and diagrams provided in documentation package.

Center of Gravity

See instructions on lifting drawings available on request.

Unit Isolation and Leveling

Provide a foundation with sufficient strength and mass to support the unit operating weight (that is, including completed piping, full operating charges of refrigerant and oil, and water). Refer to unit operating weights.

The unit must be leveled within 5 mm over its length and width. Use shims as necessary to level the unit. For additional reduction of sound and vibration, install the optional elastomeric isolators.

Elastomeric Isolators Installation (Optional)

Isolators are ready to install. Mountings must be placed on a rigid and level foundation. External equipment should not transmit additional vibration to the unit. The position of elastomeric isolator and weight per point are given the submittals drawing, which is supplied with the unit, and on the website. Wrong placement along the unit may result in excessive deflection.

Secure the isolators to the mounting surface using the mounting slots in the isolator's base plate. Do NOT fully tighten the isolators mounting bolts currently. See the isolators submittals for isolators location, maximum weights.

Align the mounting holes in the base of the unit with the threaded positioning pins on the top of the isolators. Install the unit on the isolators and secure the isolators to the unit with a nut.

Level the unit carefully. Fully tighten the isolator mounting bolts.

Chilled/hot water piping

CAUTION The CMAF unit must be connected to both hydraulic circuits, being the chilled water loop and the hot water loop. The CMAF unit cannot work without having both cooling and heating water loops connected.

Chilled/Hot Water Exchanger water connections are grooved. Thoroughly flush all water piping to the unit before making the final piping connections to the unit.

Components and layout will vary slightly, depending on the location of connections and the water sources.

CAUTION Equipment Damage! If using an acidic commercial flushing solution, construct a temporary bypass around the unit to prevent damage to internal components of chilled/hot water exchanger.

CAUTION Proper Water Treatment! The use of untreated or improperly treated water in the unit may result in scaling, erosion, corrosion, algae or slime. It is recommended that the service of a qualified water treatment specialist be engaged to determine what water treatment, if any, is required. Trane assumes no responsibility for equipment failures which results from untreated or improperly treated water or saline or brackish water.

Drainage

Locate the unit near a large capacity drain for water vessel draining down during shutdown or repair. Chilled/hot water exchangers are provided with drain connections. Refer to “Water Piping.” All local and national codes apply.

Water Treatment

In the Chilled/Hot Water Exchanger the following material are in contact with water:

- Plate material: AISI 316 EN 10028-7 - 1.4401 +2B/2R
- Connection: AISI 316 EN 10272 -1.4401/1.4404/1.4435/1.4436 - 1E
- Braze alloy: EN-13388, ISO Copper CU-HCP

When the unit is supplied with hydraulic module, the following additional materials are in contact with water:

- Pump frame and connections are made of cast iron
- Water pipes are made of carbon steel
- Pipe sealings are made of EPDM rubber (ethylene propylene diene monomer rubber)
- Pump sealings are made of silicon carbide
- Strainer is made of stainless steel

Dirt, scale, products of corrosion, and other foreign material will adversely affect heat transfer between the water and system components. Foreign matter in the chilled-water system can also increase pressure drop and consequently, reduce water flow. Proper water treatment must be determined locally, depending on the type of system and local water characteristics.

Neither salt nor brackish water is recommended for use in Trane air-cooled unit. Use of either will lead to an unpredictably shorter life cycle. Trane encourages the employment of a reputable water treatment specialist, familiar with local water conditions, to assist in this determination and in the establishment of a proper water treatment program.

If calcium chloride is used for water treatment, an applicable corrosion inhibitor must also be used. Failure to do so may result in damage to system components. Do not use untreated or improperly treated water.

Equipment damage may occur.

Piping

Piping components include all devices and controls used to provide proper water system operation and unit operating safety. A typical Chilled/Hot Water Exchanger piping is shown below.

Figure 5 - Unit typical water circuit

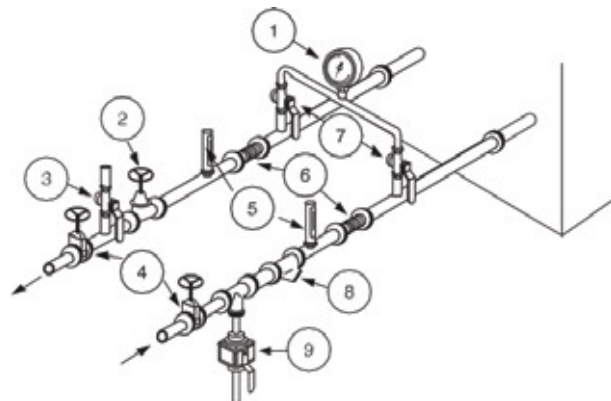

1 = Pressure gauges: show entering and leaving water pressure

2 = Balancing valve: adjusts water flow.

3 = Air purge allows to remove the air from the water circuit during fill up.

4 = Stop valves: isolate the unit and water circuiting pump during maintenance operations.

5 = Thermometers: indicate chilled water entering and leaving temperatures.

6 = Expansion compensators: avoid mechanical stress between the unit and piping installation.

7 = Stop valve located on the outlet connection: used to measure the water pressure inlet or outlet of chilled/hot water exchanger.

8 = Strainer: avoid getting heat exchangers dirty. All installation must be equipped with efficient strainer in order that only clean water enters exchanger. If there is no strainer, reserve will be formulated by the Trane technician at the start-up of the unit. The trainer used must be able to stop all particles with a diameter greater than 1 mm.

9 = Draining: used as the draining the plate heat exchanger.

10 = Do not start the unit with low water volume or not enough pressurized circuit.

Note: A pressure switch device to detect lack of water is not included in the pump package. Installation of this type of device is highly recommended to avoid sealing damage due to operation of pump without enough water.



An air vent is located on top of the Chilled/Hot Water Exchanger at the unit water outlet. Be sure to provide additional air vents at the highest points in the piping to remove air from the chilled water system. Install necessary pressure gauges to monitor the entering and leaving water pressure.

Provide shut off valves in lines to the gauges to isolate them from the system when they are not in use. Use rubber vibration eliminators to prevent vibration transmission through the water lines.

If desired, install thermometers in the lines to monitor entering and leaving water temperatures.

Install a balancing valve in the leaving water line to control water flow balance.

Install shutoff valves on both the entering and leaving water lines so that the Chilled/Hot Water Exchanger can be isolated for service.

CAUTION! The water connections to the chilled/ hot water exchangers must be “grooved pipe” type connections. Do not attempt to weld these connections, because the heat generated from welding can cause microscopic and macroscopic fractures on the heat exchanger connection that can lead to premature failure of the connection. An optional grooved pipe stub and coupling should be used for welding on flanges.

To prevent damage to chilled-water components, do not allow Chilled/Hot Water Exchanger pressure (maximum working pressure) to exceed 10 Bar. The maximum service pressure depends on free cooling type and potential pump package option. The value of max service pressure is indicated on unit nameplate.

Entering Water Piping

- Air vents to bleed the air from the system (to be placed on the highest point)
- Water pressure gauges with shutoff valves
- Vibration eliminators
- Shutoff (isolation) valves
- Thermometers if desired (temperature readings available on unit controller display)
- Clean-out tees
- Pipe strainer

Leaving Water Piping

- Air vents to bleed the air from the system (to be placed on the highest point)
- Water pressure gauges with shut off valves
- Vibration eliminators
- Shutoff (isolation) valves
- Thermometers (temperature readings available on the unit controller display)
- Clean-out tees
- Balancing valve
- Flow Proving Device

Pressure Gauges

Install field-supplied pressure components. Locate pressure gauges or taps in a straight run of pipe; avoid placing them near elbow (at least at 10 pipe diameters from discontinuity).

To read manifold pressure gauges, open one valve and close the other (depending on the side of the desired reading), this eliminates errors resulting from differently calibrated gauges installed at unmatched elevations.

Chilled/Hot Water Flow Switch

The flow switch to be installed on customer plant evaporator side are obligatory to keep the warranty. No water flow control device is installed on the unit so, flow switch is always provided as a loose accessory and must be installed by the customer on the plant evaporator side

Minimum/recommended water content

The water volume is an important parameter because it permits several things:

1. It avoids short cycle operation of the compressors. Parameters which influence the minimum compressor running time
 - Water loop volume
 - Load fluctuation
 - Number of capacity steps
 - Compressors rotation
 - Dead band (adjustable on unit controller)
 - Minimum running time of a compressor
2. On both chilled and hot water loops, it permits to smooth water temperature fluctuations leaving the CMAF unit whilst a circuit transitions from a mode to another.
3. On hot water loop it permits to keep a leaving temperature hot enough when defrosting cycles occur:
 - Assures the unit to defrost both circuits in a row
 - Assures continuous operation and to run

Exchangers the most effective way.

For chilled water loop, the minimum water content shall be in accordance with point 1.

For hot water loop, the minimum water content shall be the maximum of recommendations #1 and #2.

1. Avoid short cycles

For comfort application, we can allow water temperature fluctuation at part load. The parameter to consider is the minimum operating time of the compressor. To avoid lubrication problem on a scroll compressor it must run at least 2 minutes

(120 seconds) before it stops.

The minimum volume can be determined by using the following formula:

$$\text{Volume} = \frac{(\text{Maximum unit capacity} \times \text{time} \times \text{step high})}{(\text{specific heat} \times \text{dead band})}$$

With:

- Maximum unit capacity (kW) at full load
- time (seconds), 120s minimum operating time
- $\text{step}_{\text{high}}$ (%), $\frac{(\text{Largest compressor Tonnage})}{(\text{Unit tonnage})}$
- specific heat (kJ/kg) e.g., 4.18 for water
- dead band (K) (default value see Table 9)

Table 8 - Brine specific heat (kJ/kg) at 30% concentration

Temperature (°C)	Propylene Glycol	Ethylene Glycol
-10	4.80	4.30
0	4.44	4.22
10	4.18	4.07
20	4.00	3.87
30	3.86	3.65
40	3.72	3.41
50	3.55	3.18
60	3.31	2.97
70	2.96	2.80

Table 9 - Default Dead band and highest compressor step

Unit Size	040	045	050	055	065
Highest Step	24%	27%	25%	29%	25%
Default Dead Band	1.8				
Unit Size	070	075	085	095	105
Highest Step	29%	28%	25%	27%	25%
Default Dead Band	1.3				

Note: To estimate the capacity, it is recommended to select at full load according ambient temperature which the needs are the lowest and the unit cooling/heating capacities the highest, e.g.

- The lowest ambient air temperature for cooling mode
- The highest ambient air temperature for heat pump mode.

It is also essential to consider the brine specific heat, in case of the use of glycol refer to Table 6.

Process applications will need more water volume to minimize the water temperature fluctuation at part load.

2. Coil defrosting

When the unit is running in heat pump mode with ambient air temperature below +7°C coils may be subject to ice formation. The unit controller can initiate a defrost cycle to melt the ice to recover a reasonable capacity.

In case ambient air will not drop below +7°C recommendations below do not apply.

The leaving temperature may be colder during few minutes defrosting and shall be mixed into a buffer tank.

Table 10a - Typical water content (m3) including buffer SE Versions

Size	Content m3
040	0,7
045	0,9
050	0,9
055	1,2
065	1,2
070	1,5
075	1,5
085	1,5
095	1,8
105	1,8

Table 10b - Typical water content (m3) including buffer HE version

Size	Content m3
040	0,7
045	0,9
050	0,9
055	1,2
065	1,2
070	1,6
075	1,5
085	1,5
095	1,8
105	1,8

3. Mode transitioning

For both chilled and hot water loop, when the unit is transitioning a circuit from a mode to another, e.g., heat recovery to heat pump / cooling or vice-versa the minimum content against short cycle is largely sufficient to smooth the supply temperature.

Chilled/hot water exchanger pressure drop

Table 11 - Plate number of CMAF Chilled / Hot Water Exchanger

Unit Size	040	045	050	055	065	070	075	085	095	105
Chilled water	130	130	130	202	202	138	138	138	166	166
Hot Water	202	202	202	250	250	106	106	138	138	138

Flow rates below the minimum recommendation must be avoided to avoid laminar flow, potential exchanger freezing scaling and poor temperature control.

Integrated pump package

Installation - Mechanical (Water pumps)

Unit can be ordered with optional integrated hydraulic modules, provided with the following components factory mounted and tested:















- Centrifugal water pump, Low pressure, or High pressure (option)
- Water strainer to protect the pump against impurities in the circuit
- Expansion module with expansion vessel and pressure relief valve sufficient to ensure the expansion of the water loop ability (chilled water pump only)
- Thermal insulation for antifreeze protection
- Variable speed drive (Optional) for equilibrate the flow of water circuit
- Drain valve
- Temperature sensor

Note: A pressure switch device to detect lack of water is not included in the pump package. Installation of this type of device is highly recommended to avoid sealing damage due to operation of pump without enough water.

Pump package schematics is supplied in the documentation set shipped with the unit.

Schematic pump package

Figure 11 - Example of Hydronic Group Schematic Single Pump Package for chilled water exchanger

	Temperature Probe
	Relief Valve
	Expansion Vessel
	Gauges
	Safety Valve (6 bar)
	Shut Off Valve
	Pump
	Water Charge
	Water Discharge
	Check Valve
	Water Tank
	Antivibration System
	Flow Switch
	Filter
	2 Way Valve With ON/OFF Servo Control

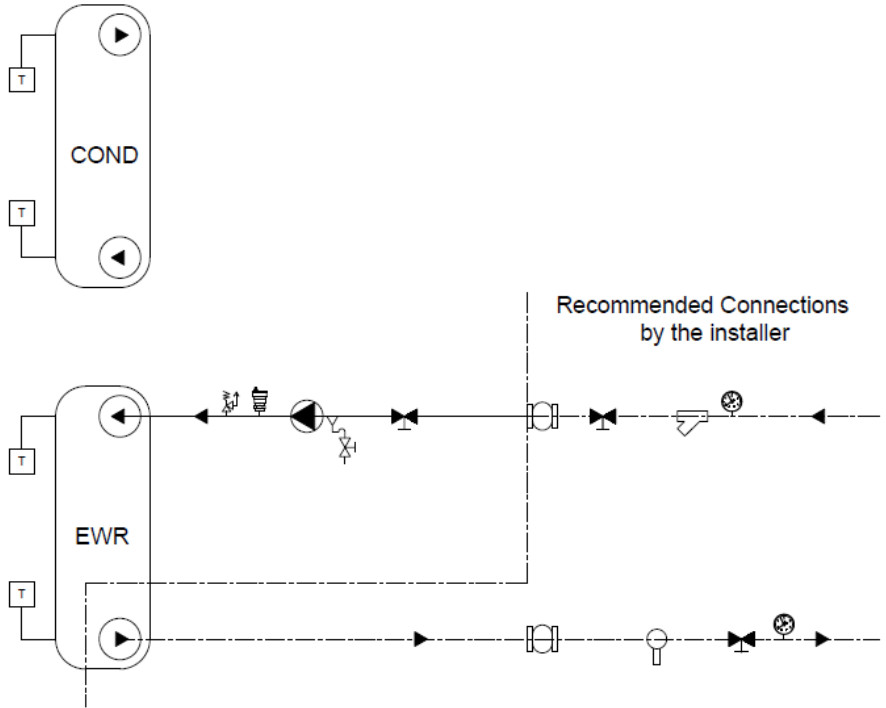















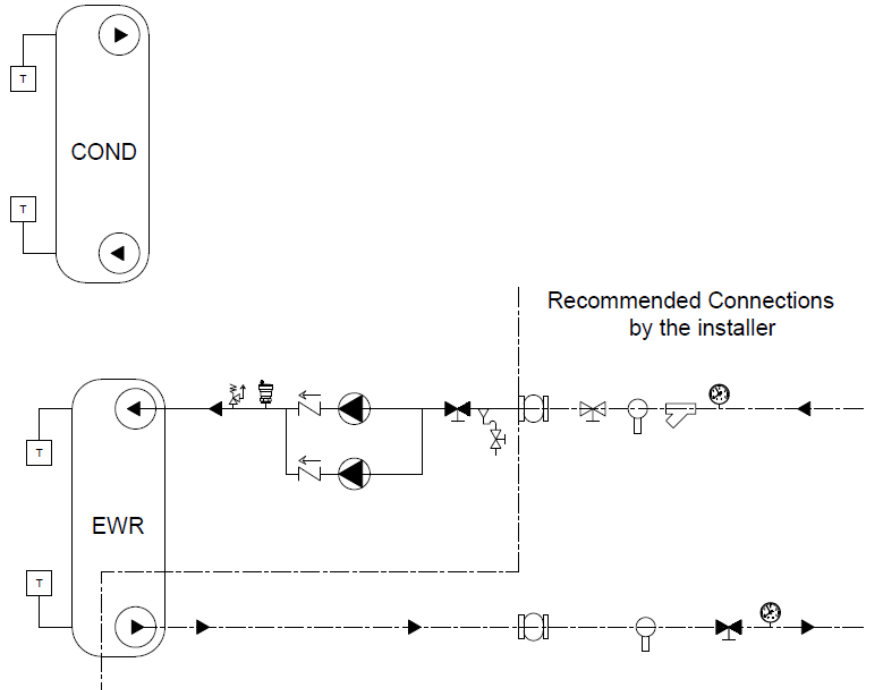

















Figure 11b - Example of Hydronic Group Schematic Double Pump Package for chilled water exchanger

	Temperature Probe
	Relief Valve
	Expansion Vessel
	Gauges
	Safety Valve (6 bar)
	Shut Off Valve
	Pump
	Water Charge
	Water Discharge
	Check Valve
	Water Tank
	Antivibration System
	Flow Switch
	Filter
	2 Way Valve With ON/OFF Servo Control



Installation - Mechanical (Water pumps)

Figure 12 - Example of Hydronic Group Schematic Single Pump Package for Hot Water Exchanger

	Temperature Probe
	Relief Valve
	Expansion Vessel
	Gauges
	Safety Valve (6 bar)
	Shut Off Valve
	Pump
	Water Charge
	Water Discharge
	Check Valve
	Water Tank
	Antivibration System
	Flow Switch
	Filter
	2 Way Valve With ON/OFF Servo Control

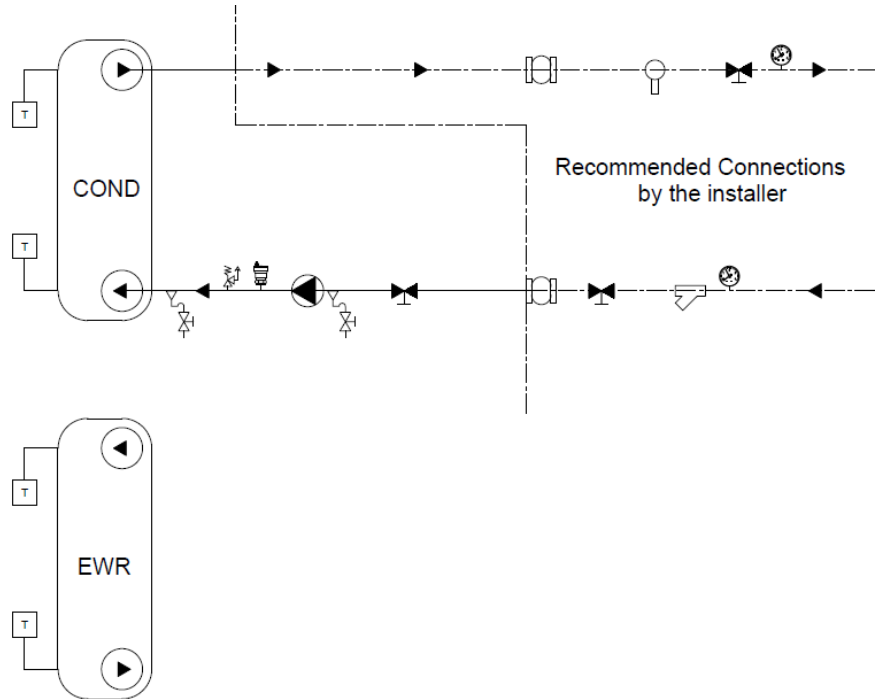















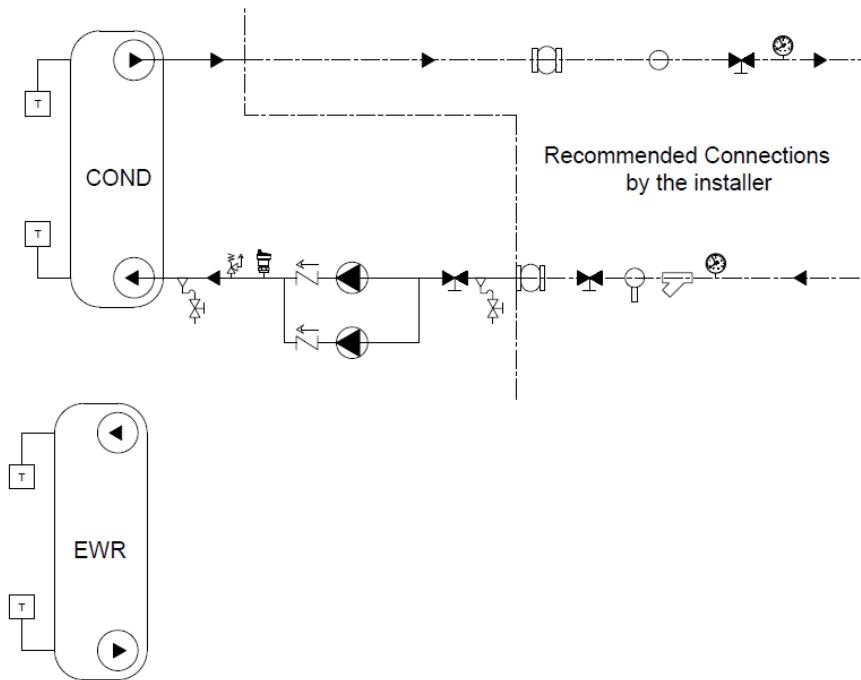

Figure 12b - Example of Hydronic Group Schematic Double Pump Package for Hot Water Exchanger

	Temperature Probe
	Relief Valve
	Expansion Vessel
	Gauges
	Safety Valve (6 bar)
	Shut Off Valve
	Pump
	Water Charge
	Water Discharge
	Check Valve
	Water Tank
	Antivibration System
	Flow Switch
	Filter
	2 Way Valve With ON/OFF Servo Control



Integrated Pump Available Pressure

Chilled water integrated pump available pressure

In the figures below are described pump curves (Standard Head and High head) for the whole CMAF unit range.

Pumps available standard head:

Unit sizes	Standard head Pump	P2 (kW)	Efficiency Class IE (motor)	Max flow m ³ /h
40	3D-40-160/3,0	3.44	IE3	42
45				
50				
55				
65	3D-50-160/5,5	6.09	IE3	72
70	3D 50-125/4	4.52	IE3	72
75				
85				
95				
105	3D 65-125/5,5	6.09	IE3	126

Performance curves

40-160/3.0 (3.0kW) MEI > 0.70 – Impeller diameter = 151 mm

40-160/4.0 (4.0kW) MEI > 0.70 – Impeller diameter = 166 mm

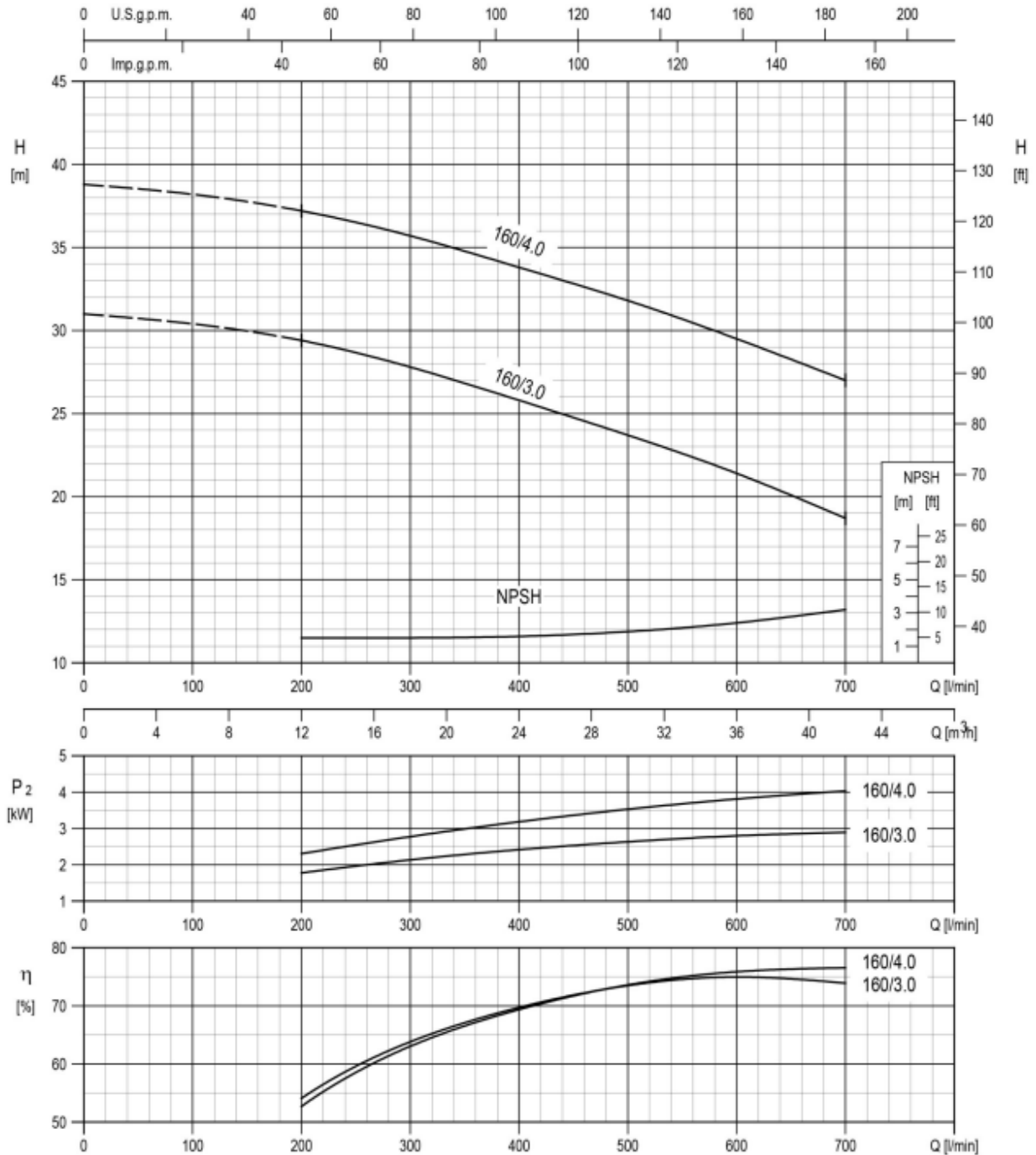



50-125/2.2 (2.2kW) MEI > 0.60 – Impeller diameter = 126 mm
50-125/3.0 (3.0kW) MEI > 0.60 – Impeller diameter = 131 mm
50-125/4.0 (4.0kW) MEI > 0.60 – Impeller diameter = 140 mm

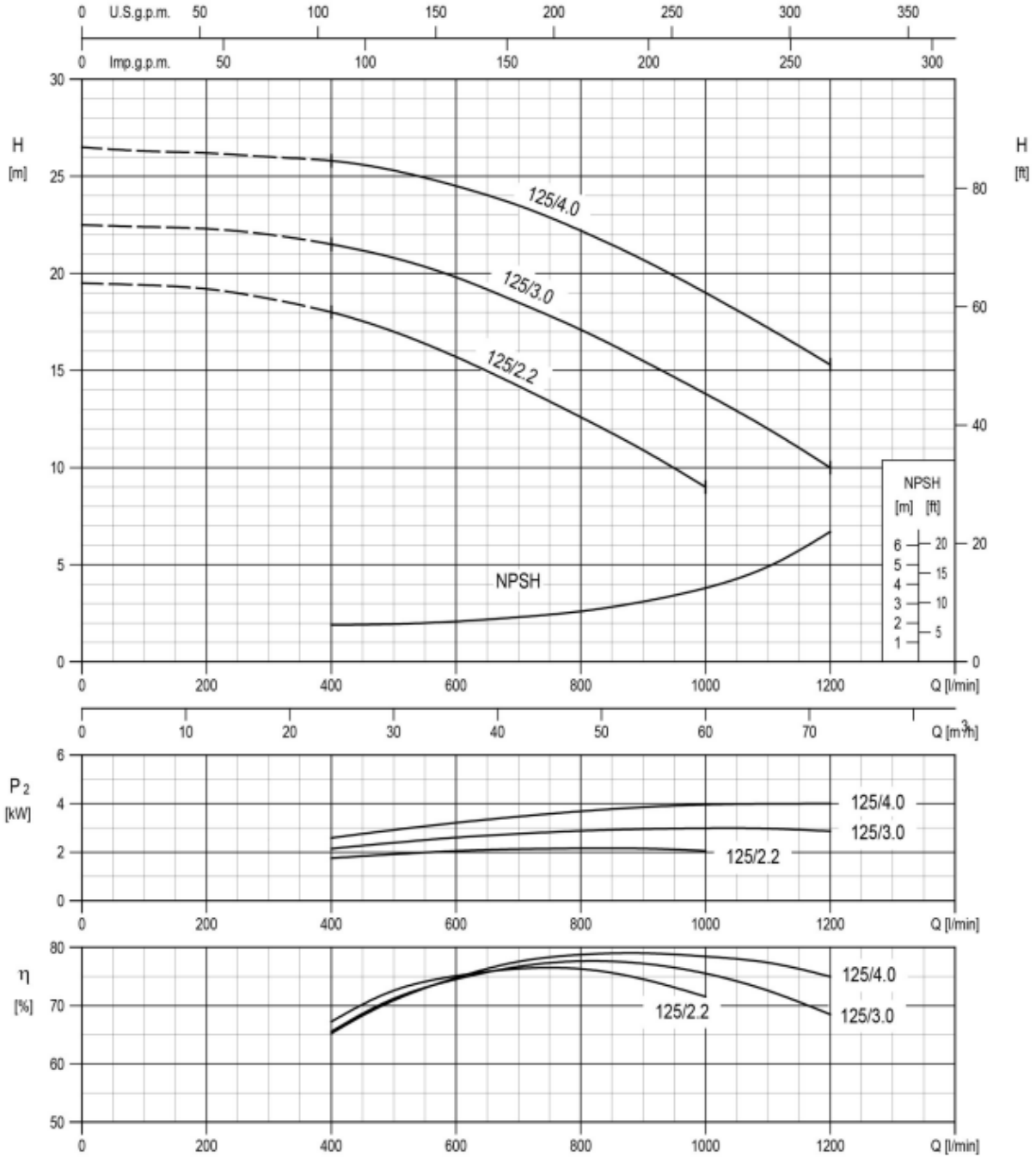

50-160/5.5 (5.5kW) MEI > 0.70 – Impeller diameter = 154 mm
50-160/7.5 (7.5kW) MEI > 0.70 – Impeller diameter = 166 mm

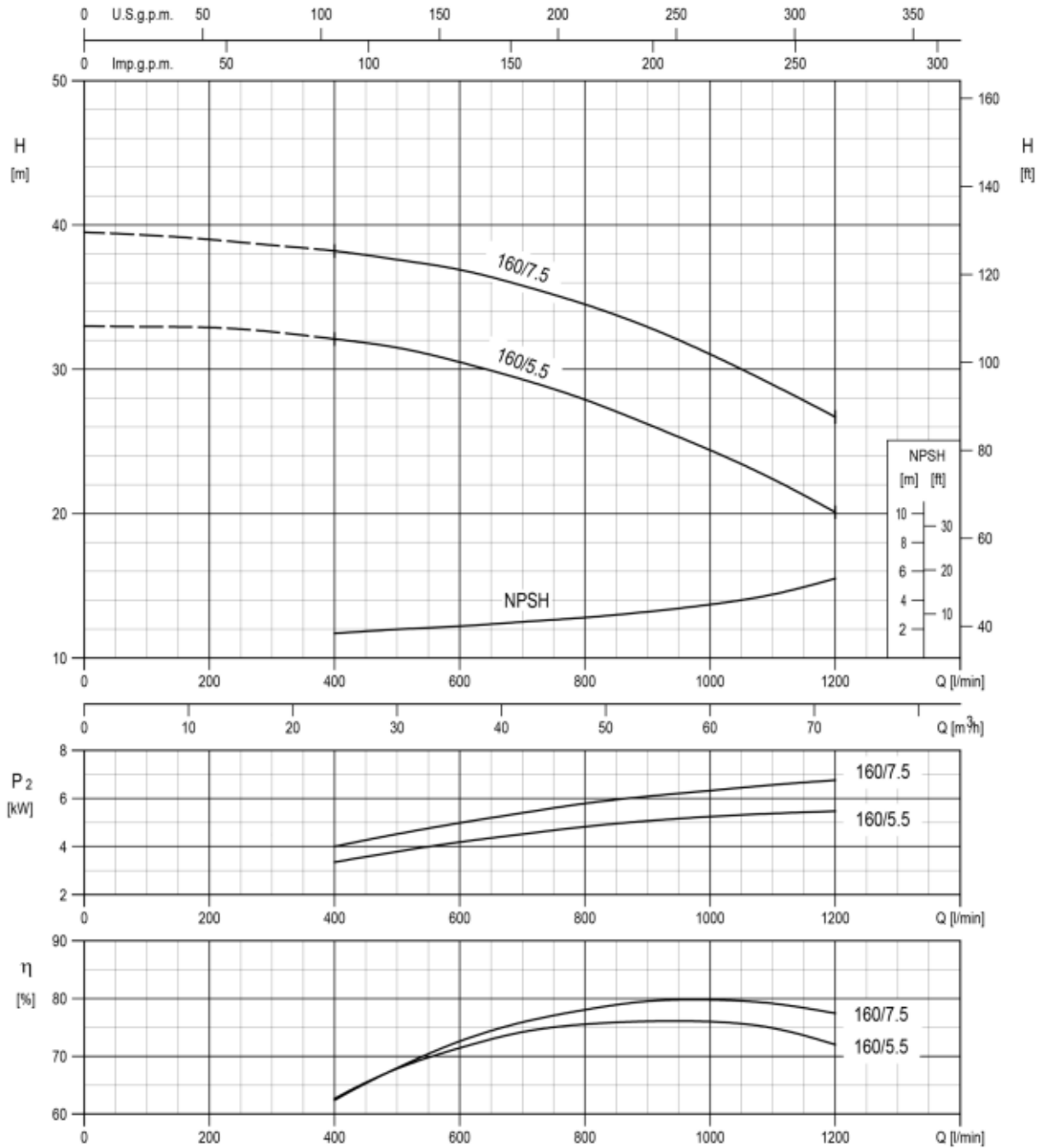

65-125/4.0 (4.0kW) MEI > 0.70 – Impeller diameter = 128 mm
65-125/5.5 (5.5kW) MEI > 0.70 – Impeller diameter = 138 mm
65-125/7.5 (7.5kW) MEI > 0.70 – Impeller diameter = 149 mm

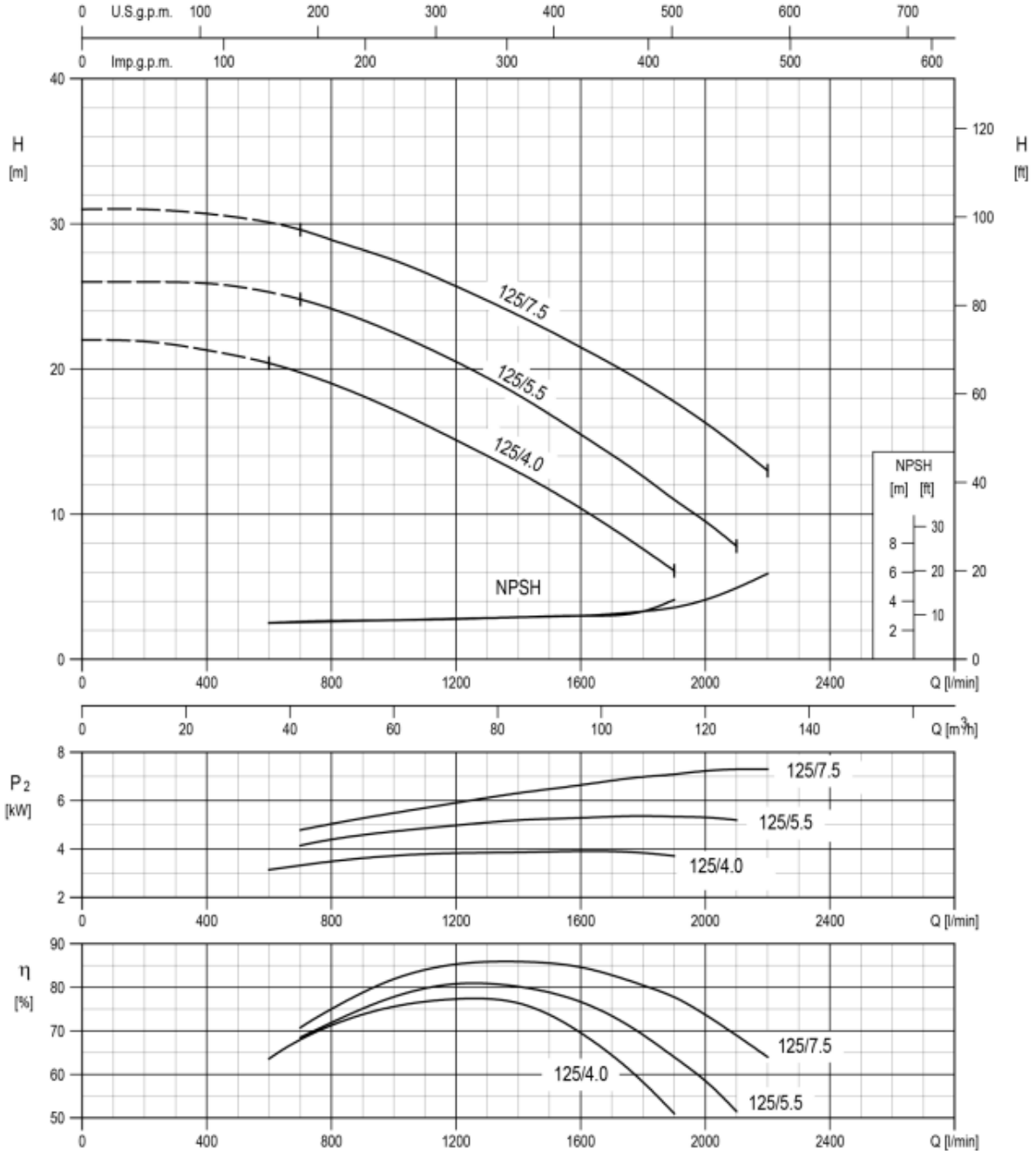

Pumps available High Head:

Unit sizes	High head Pump	P2 (kW)	Efficiency Class IE (motor)	Max flow m ³ /h
40	3D-40-160/4,0	4.52	IE3	42
45				
50				
55				
65	3D-50-160/7,5	8.26	IE3	72
70				
75				
85				
95	3D 65-160/9.2	10.12	IE3	132
105				

Performance curves

40-160/3.0 (3.0kW) MEI > 0.70 – Impeller diameter = 151 mm

40-160/4.0 (4.0kW) MEI > 0.70 – Impeller diameter = 166 mm

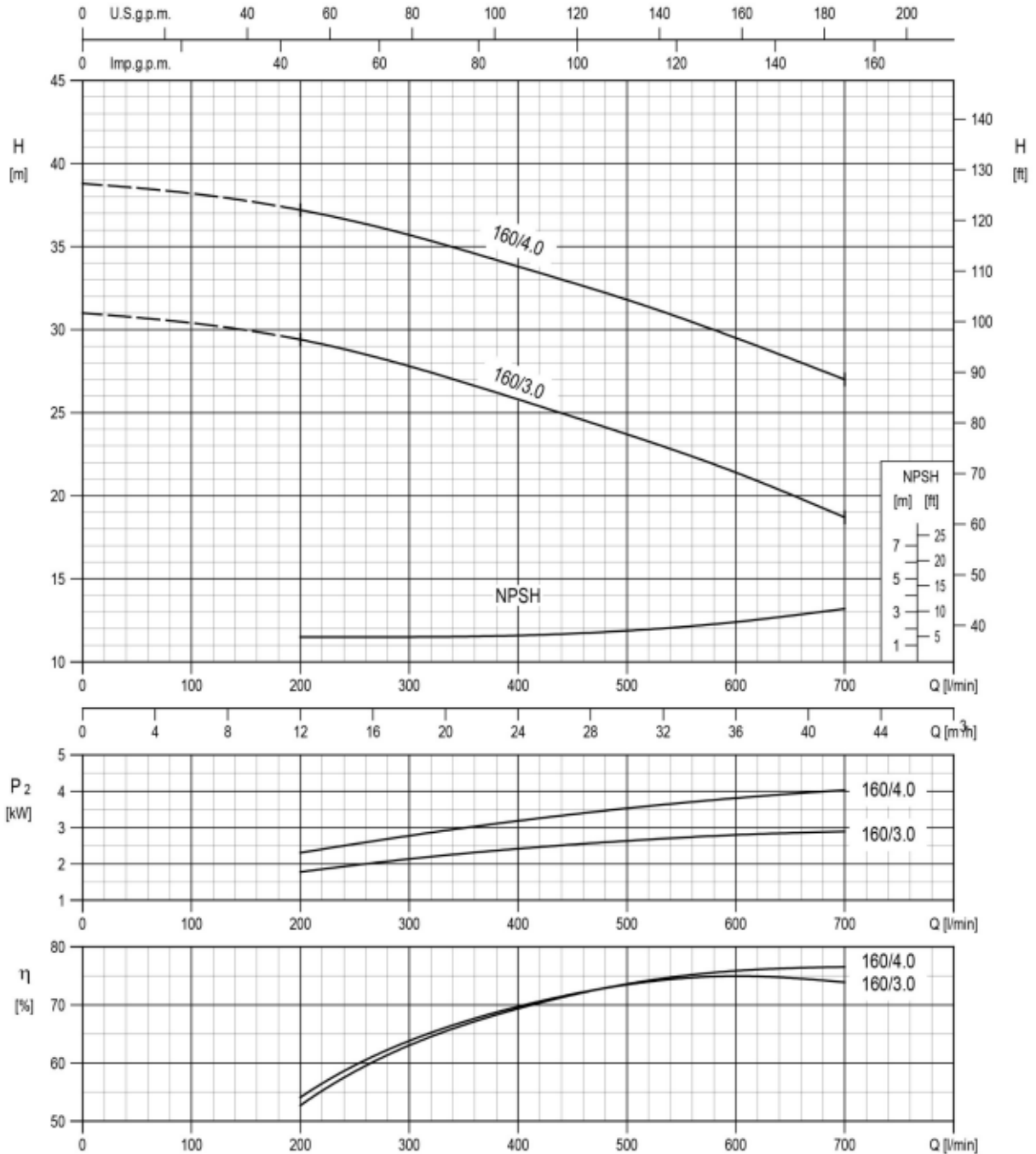

50-160/5.5 (5.5kW) MEI > 0.70 – Impeller diameter = 154 mm
50-160/7.5 (7.5kW) MEI > 0.70 – Impeller diameter = 166 mm

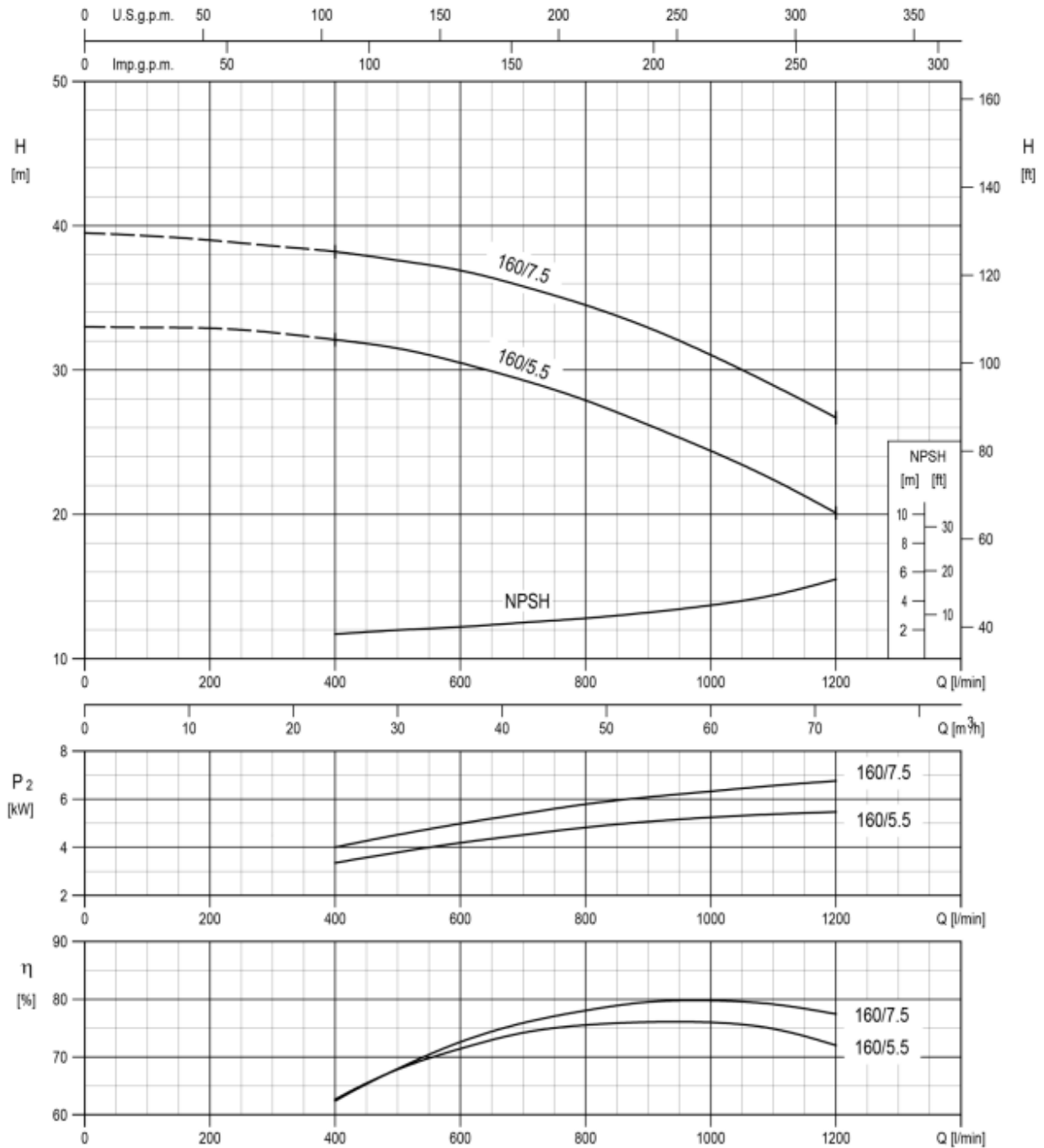



65-160/7.5 (7.5kW) MEI > 0.70 – Impeller diameter = 153 mm
65-160/9.2 (9.2kW) MEI > 0.70 – Impeller diameter = 160 mm
65-160/11 (11kW) MEI > 0.70 – Impeller diameter = 168 mm
65-160/15 (15kW) MEI > 0.70 – Impeller diameter = 178 mm

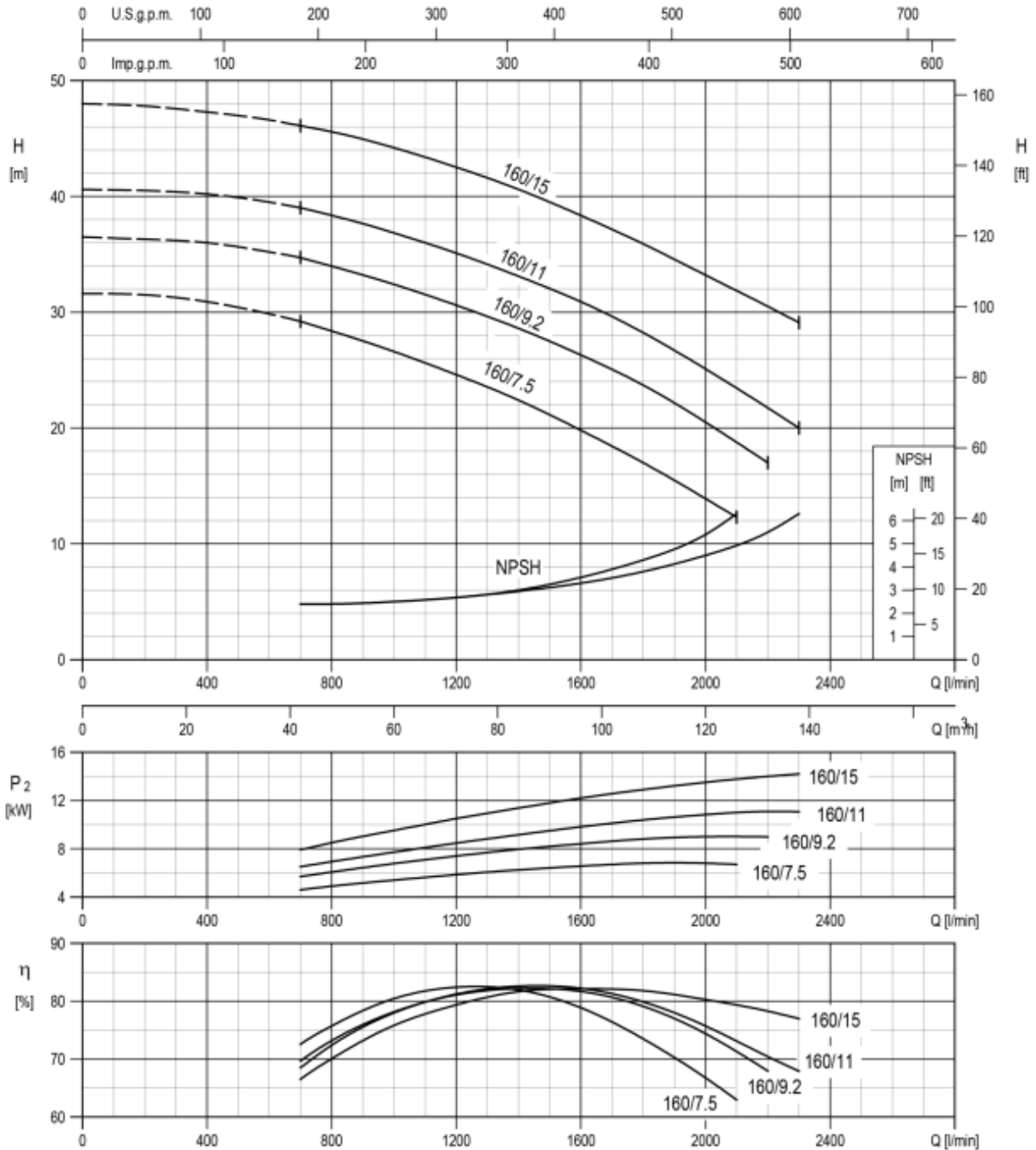

Chilled/hot water freeze protection

Freeze Protection

Depending on the ambient temperature the unit may be exposed to freeze, there are multiple options for freeze protection. They are listed in order of highest ambient (least freeze protection) to the lowest ambient (most freeze protection).

For all units running with water under cold ambient temperature (below 0°C), it is extremely important to keep full water flow in the Chilled/Hot Water for an extended time after last compressor stops. This will protect chilled/hot water exchanger from freezing by refrigerant migration. Therefore Chilled/Hot Water Exchanger water pump output relay must be used to control the water pumps. This is not mandatory if glycol is used with protection down to lowest ambient expected.

1. Water pump and heaters

- a. Heaters are factory installed on brazed plates exchangers. They will protect it from freezing in ambient temperatures down to -18°C. Heaters are installed on the water piping and on the pumps of units equipped with hydraulic module.
- b. Install heat tape on all water piping, pumps, and other components that may be damaged if exposed to freezing temperatures. Heat pump must be designed for low ambient temperature applications. Heat tape selection should be based on the lowest expected ambient temperature.
- c. Tracer Symbio™ 800 controller can start the pump(s) when freezing conditions are detected. For this option for the pumps must be controlled by the CMAF unit and this function validated on the unit controller.
 - a) Water shut off valves need to always stay open.

Note: Water pump control and heater combination will protect the Chilled/Hot Water Exchanger down to any ambient temperature if provided power is available to the pump and the Tracer Symbio™ 800. This option will NOT protect the exchangers in the event of power failure to the unit unless backup power is supplied to the necessary components.

OR

2. Freeze inhibitor

- a. Freeze protection can be accomplished by adding sufficient glycol to protect against freezing down to the lowest ambient expected.
- b. See “Chilled / hot water exchanger glycol requirement” section for guidance on determining the glycol concentration.

Note: Use of glycol type antifreeze reduces the cooling capacity of the unit and must be considered in the design of the system specifications.

CAUTION! When using freeze inhibitor, never fill the system with pure glycol.

Always fill the system with diluted solution. Maximum concentration of glycol is 40%. Higher glycol concentration will damage pump seal.

OR

3. Drain water circuit

For ambient temperatures below -20°C and for installation not including either option 1 or 2 above described.

- a. Shut off power supply to unit and to all heaters.
- b. Purge the water circuit
- c. Blow out the chilled/hot water exchanger to ensure that no liquid is left inside the Chilled/Hot Water Exchanger and the water lines. Drain the pump.

Note: It is not recommended to drain the water circuit for the following reasons.

1. The water circuit will rust, and its lifetime could be reduced.
2. Water will remain in the bottom of the plate heat exchangers and freeze damage could occur.

CAUTION! Chilled / hot water exchanger damage!

If insufficient concentration or no glycol is used, the Chilled/Hot Water Exchanger water pumps must be controlled by the Tracer Symbio™ 800 to avoid severe damage to exchangers due to freezing. A power loss of 15 minutes during freezing can damage the exchangers. It is the responsibility of the installing contractor and/ or the customer to ensure that a pump will start when called upon by the unit controls. Please consult TRANE service for unit setting and % of glycol required.

With factory-fitted disconnect switch option, exchanger trace heating is taken from the live side of the isolator. Therefore, the heaters are energized if the main switch is closed. Supply voltage to the heating tapes is 400V.

- Avoid the use of very low or near minimum chilled fluid flow rates through the unit. Higher velocity chilled fluid flow reduces freeze risk in all situations.
- Flow rates below limits have increased freeze potential and have not been considered by freeze protection algorithms.
- Avoid applications and situations that result in a requirement for rapid cycling or repeated starting and stopping of the unit. Keep in mind that unit control algorithms may prevent a rapid compressor restart after shutting down when the chilled/hot water exchanger has been operating nearby or below the LRTC (Low Refrigerant Temperature Cutout) limit.
- Maintain refrigerant charge at appropriate levels. If charge is in question, contact Trane service. A reduced or low level of charge can increase the likelihood of freezing conditions in the chilled/hot water exchanger and/or LRTC diagnostic shutdowns.



The warranty will be void, in case of freezing due to the lack of use of either of these protections.

Low refrigeration temperature setpoint and antifreeze setpoint on CMAF unit control

CAUTION! The unit is provided with standard factory settings. It can be necessary to modify the Low Pressure (LP) saturation temperature and the Antifreeze Setpoint (AS) on the unit control. Based on the following examples, it is necessary to modify on the unit control the following settings:

- The LP saturation temperature
- The antifreeze setpoint

Examples on Figure 13:

- 7°C, the LP setting must be -4°C where the antifreeze setting shall be 2°C
- 2°C, the LP setting must be -9°C where the antifreeze setting shall be -4°C
- -2°C, the LP setting must be -13°C where the antifreeze setting shall be -7.5°C

Freeze protection with glycol

It is mandatory to use a freeze inhibitor for leaving water setpoint less or equal to 5°C. On the glycol recommended concentration figure 18, you must select concentration on or above the curve. For example, for -4°C brine temperature, a concentration of 25% ethylene glycol is not sufficient. The concentration must be 28% ethylene glycol or 33% propylene glycol.

Using glycol with hydraulic module

If the glycol brine percentage is not at the recommended percentage, corrosion inhibitor present in the glycol may not be efficient enough. For instance, a glycol concentration of 15% will provide freeze protection to the unit down to -5°C, but it might generate additional corrosion.

Figure 15 - LP setting Vs. Leaving Water Temperature set point

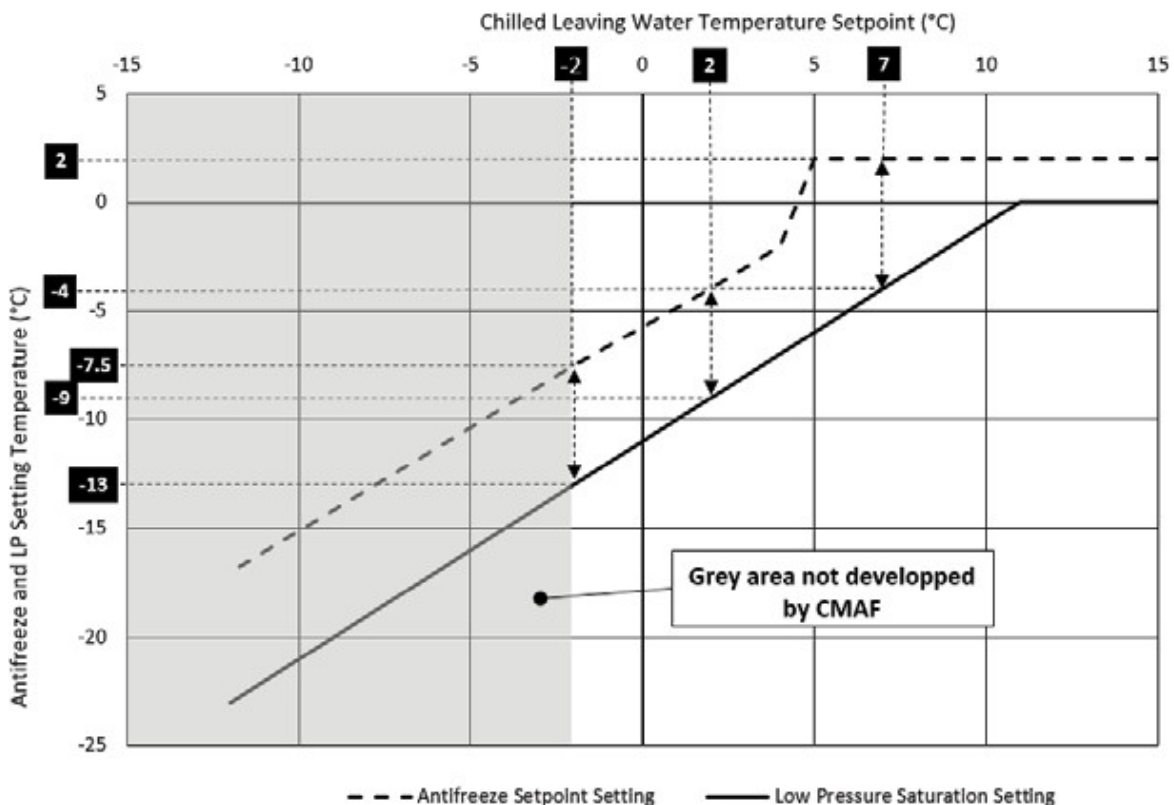
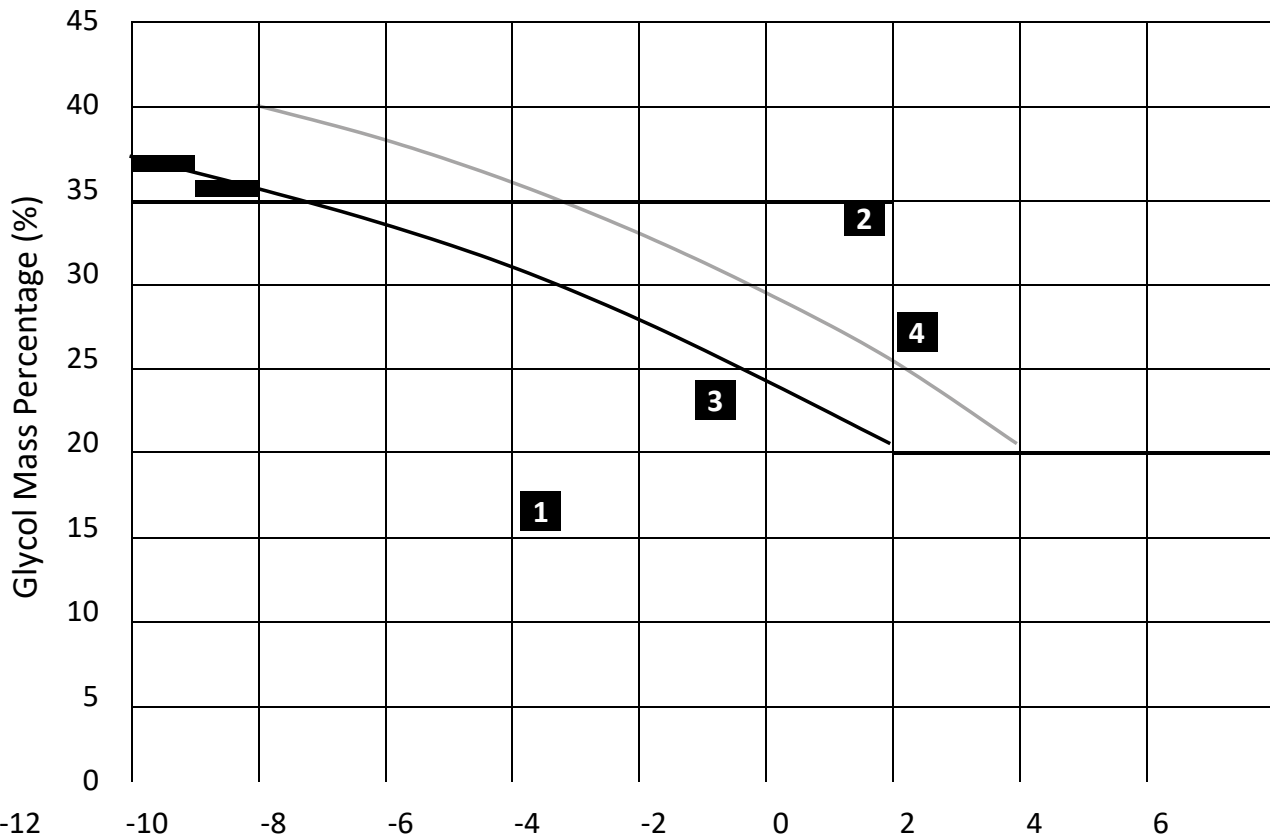

Figure 16 - Glycol percentage recommendation curve



Water Leaving Setpoint (°C)

- 1 = Critical risks of freezing
- 2 = Efficient freeze protection
- 3 = Ethylene glycol
- 4 = Propylene glycol
- % = Glycol percentage (mass concentration)
- °C = Glycol or water temperature

CAUTION!

1. Additional glycol beyond the recommendations will adversely affect unit performance. The unit efficiency will be reduced, and the saturated suction temperature will be reduced. For some operating conditions this effect can be significant.
2. If additional glycol is used, then use the actual % glycol to establish the low refrigerant cutout set point with Trane service advice.
3. The minimum low refrigerant cutout set point allowed is - 20.6 °C. This minimum is established by the solubility limits of the oil in the refrigerant.
4. With glycol application, ensure that there is no fluctuation of brine flow versus Order Write Up value, as a reduction of flow will adversely affect unit performance and behavior.
5. Full unit simulation is required for proper prediction of unit performance for specific operating conditions. For information on specific conditions, contact Trane.



General Electrical Recommendations

Electrical Parts

When reviewing this manual keep in mind.

- All field-installed wiring must be in accordance with local regulations, CE directives and guidelines. Be sure to satisfy proper equipment grounding requirements according to CE
- The following standardized values - Maximum Amps - Short Circuit Amps - Starting Amps are displayed on unit nameplate.
- All field-installed wiring must be checked for proper terminations, and for possible shorts or grounds.

Note: Always refer to wiring diagrams shipped with unit package or unit submittal for specific electrical schematic and connection information.

Important: To prevent control malfunctions, do not run low voltage wiring (<30V) in conduit with conductors carrying more than 30 volts.

WARNING! Hazardous Voltage with Capacitor! Disconnect all electric power, including remote disconnects and discharge all motor start/run and AFD (Adaptive Frequency TM Drive) capacitors before servicing. Follow proper lockout/tagout procedures to ensure the power cannot be inadvertently energized.

- For variable frequency drives or other energy storing components provided by Trane or others, refer to the appropriate manufacturer's literature for allowable waiting periods for discharges capacitors. Verify with an appropriate voltmeter that all capacitors have discharged
- DC bus capacitors retain hazardous voltages after input power has been disconnected. Follow proper lockout/tagout procedures to ensure the power cannot be inadvertently energized
- After disconnecting input power, wait five (5) minutes for units which are equipped with EC fans and wait twenty (20) minutes for units which are equipped with variable frequency drive (0V DC) before touching any internal components.
- Failure to follow these instructions could result death or serious injury

For additional information regarding the safe discharge of capacitors, see "Adaptive Frequency™ Drive (AFD3) Capacitor Discharge" and BAS-SVX19B-E4.

Hazardous Voltage - Pressurized Burning Fluid! Before removing compressor terminal box cover for servicing, or servicing power side of control panel, CLOSE COMPRESSOR DISCHARGE SERVICE VALVE

and disconnect all electric power including remote disconnects. Discharge all motor start/run capacitors. Follow lockout/tagout procedures to ensure the power cannot be inadvertently energized. Verify with an appropriate voltmeter that all capacitors have discharged.

The compressor contains hot, pressurized refrigerant. Motor terminals act as a seal against this refrigerant. Care should be taken when servicing NOT to damage or loosen motor terminals.

Do not operate compressor without terminal box cover in place.

Failure to follow all electrical safety precautions could result in death or seriously injure.

CAUTION! To avoid corrosion, overheating or general damage, at terminal connections, unit is designed for copper mono-conductors only. In case of multiconductor cable, an intermediate connection box must be added. For cable with alternative material, bi-material connecting devices are mandatory. Cable routing inside control panel should be made case by case by installer.

Do not allow conduit to interfere with other components, structural members, or equipment. Control voltage (115V) wiring in conduit must be separate from conduit carrying low voltage (<30V) wiring. To prevent control malfunctions, do not run low voltage wiring (<30V) in conduit with conductors carrying more than 30V.

WARNING! The Warning Label is displayed on the equipment and shown on wiring diagrams and schematics. Strict adherence to these warnings must be observed. Failure to do so may result in personal injury or death.

CAUTION! If digit 8 G is selected, the customer's electrical system must be equipped, on the power supply circuit of the machine, with an insulation monitor - suitably coordinated with the earth system - to ensure the detection of an earth fault.

CAUTION! Units must not be linked to the neutral wiring of the installation. Units are compatible with the following neutral operating conditions:

TNS	IT	TNC	TT
Standard	Standard**	Special	Standard*

* Differential protection should be suited for industrial machinery with current leak which can be higher than 500 mA (several motors and frequency drives).

** Filter RFI disconnect on VPF and EC fan.

Electrical data

To get the following electrical data details: Refer to General Data tables for each unit configuration and size.

- Maximum Power input (kW)
- Unit rated amps (Max comp + Fan + Control)
- Unit start up amps (Starting Amps of the largest comp + RLA of 2nd comp + RLA of all fans+ control)
- Compressor Power factor
- Disconnect switch size (A)
- Short Circuit Rating for all sizes =15 kA

Wiring diagrams are shipped with unit and can be found in the unit control panel.

Note: Rating is made for 400 V, 3 phases, 50 Hz power supply.

Installer-Supplied Components

Customer wiring interface connections are shown in the electrical schematics and connection diagrams that are shipped with the unit. The installer must provide the following components if not ordered with the unit:

- Power supply wiring (in conduit) for all field-wired connections.
- All control (interconnecting) wiring (in conduit) for field-supplied devices.
- Fused-disconnect switches.

CAUTION The IT neutral (digit 8 = G) option is incompatible with Power Factor Correction Capacitors (digit 47 = A).

Power Supply Wiring

All power supply wiring must be sized and selected accordingly by the project engineer in accordance with standard IEC 60364. All wiring must comply with local codes. The installing (or electrical) contractor must provide and install the system interconnecting wiring, as well as the power supply wiring. It must be properly sized and equipped with the appropriate fuse-disconnect switches. The type and installation location(s) of the fused-disconnect switches must comply with all applicable codes.

Cut holes into the sides of the control panel for the appropriately sized power wiring conduits. The wiring is passed through these conduits and connected to the terminal blocks.

To provide proper phasing of 3 phase input, make connections as shown in field wiring diagrams and as stated on the yellow WARNING label in the starter panel. Proper equipment grounds must be provided to each ground connection in the panel.

CAUTION! Customer wiring interface connections are shown in the electrical schematics and connection diagrams that are shipped with the unit. The installer must provide the following components if not ordered with the unit.

WARNING! To prevent injury or death, disconnect all electrical power sources before completing wiring connections to the unit.

CAUTION! The use of copper mono-conductors is the preferred solution to avoid corrosion and overheating at terminal connections.

Control Power Supply

Multi-Pipe unit is provided with control power transformer, it is not necessary to provide additional control power voltage to the unit.

Heater Power Supply

The Chilled/Hot Water Exchanger are insulated from ambient air and protected from freezing for temperature down to -20°C by two thermostatically controlled immersion heaters combined with pumps activation through Tracer Symbio™ 800. Whenever the ambient temperature drops below 0°C the thermostat energizes the heaters and the Tracer Symbio™ 800 activates

the pumps. If ambient temperatures below -20°C are expected, contact your Trane local office.

CAUTION! The control panel main processor does not check for loss of power to the heat tape, nor does it verify thermostat operation. A qualified technician must frequently verify power to the heat tape and confirm operation of the heat tape thermostat, to avoid catastrophic damage to the Chilled/Hot Water Exchanger.

CAUTION! With factory-fitted disconnect switch, trace heating is taken from the live side of the isolator, so power remains on. Supply voltage to the heating tapes is 400V.

Don't energize heaters without water. In case of winter water drainage for freeze protection, it is compulsory to disconnect the Chilled/Hot Water Exchanger heaters to protect them from burning due to overheat

Water Pump Power Supply

Provide power-supply wiring with fused disconnect switch(es) for the chilled water pump(s).

Interconnecting Wiring

Chilled/Hot -Water Flow (Pump) Interlock

CMAF requires a field-supplied, control-voltage contact input through a flow proving switch (5S1/5S2) and an auxiliary contact (6K51/6K52). Connect the proving switches and auxiliary contacts to terminal 2 connector J2 cards (1A17). Refer to the field wiring diagram for details.

Chilled/Hot Water Pump Control

Chilled/hot water-pump output relay close when the unit is given a signal to go into the AUTO mode of operation from any source. The contact is opened to turn off the pump in the event of most machine-level diagnostics, to prevent the buildup of pump heat.

CAUTION! The water pump output relays must be used to control the water pumps and to benefit of the water pump timer function at unit startup and shutdown. This is required when the unit is in operation under freezing conditions, especially if the chilled / hot water loops does not contain glycol.

CAUTION! Refer to Freeze Protection section for information about the water pumps.

Alarm and Status Relay Outputs (Programmable Relays)

See CMAF User Guide for alarm and status relay outputs.

External Demand Limit Setpoint (EDLS) and External Chilled Water Setpoint (ECWS) Analog Input Signal Wiring Details, see CMAF User Guide for EDLS and ECWS.



Supplemental heat option

Supplemental heat option provides the possibility to control up to 4 additional heating stages to help to maintain the hot water supply temperature warm enough especially in coldest temperatures of winter.

It allows to improve the reliability of the unit and the seasonal efficiency of the system.

When the option is activated, it engages 1 to 4 additional heating stages when the leaving water temperature is below the hot water set point and the unit is not able to recover the set point.

The 4-relay card must be wired to heater command and additional heaters shall be installed downstream the hot water exchanger.

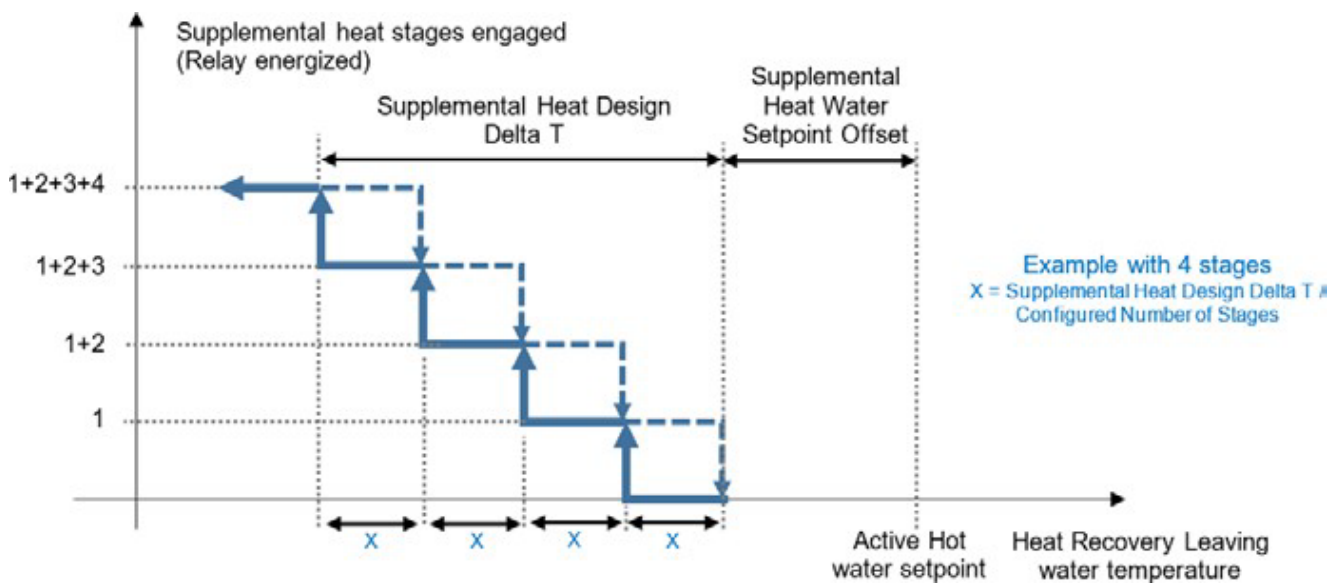

Operating Principles

This section contains an overview of the operation of the unit equipped with microcomputer-based control systems.

It describes its overall operating principles.

Note: To ensure proper diagnosis and repair, contact a qualified service organization if a problem could occur.

General

The unit has scroll compressor(s), dual circuit, air-cooled reversible coils. These units are equipped with unit-mounted starter control.

The basic components of a CMAF unit are:

- Unit-mounted panel containing starter and Tracer Symbio™ 800 controller and Input/Output LLIDS
- Scroll compressors
- Brazed plate Chilled / hot water exchanger
- Air-cooled Fin & tube coils
- Electronic Expansion Valve (EXV)
- Four Way Valves
- Actuated Isolating Valve
- Electronic Mode Valves
- Refrigerant Receiver

Refrigerant Cycle

The unit has 3 exchangers, a dedicated brazed plate Chilled/Hot Water Exchanger for respectively chilled and hot water and an air-cooled fin & tube coil exchanger.

The unit can run for each circuit one of the 3 operating modes, it can also run the heat recovery mode on a circuit with a different mode on the opposite circuit to better satisfy the cooling / heating demand.

The compressors use suction gas cooled motors and an oil management system to provide almost oil-free refrigerant to exchangers for maximum heat transfer while lubricating and sealing compressor rotors and bearings. The lubrication system helps to assure long compressor life and contributes to quiet operation.

Depending on the operating mode, the refrigerant goes through the 4 way valve and isolation valves prior to condense into coil modules or the hot water exchanger. Liquid refrigerant is metered using an electronic expansion valve into the brazed plate evaporator or

the coil exchanger to maximize unit efficiency at full and part load operation or into hot water exchanger for defrosting.

Isolation valves avoid refrigerant migration toward inactive exchanger and orient the refrigerant toward the active condenser.

The mode valves (Cooling, H/P, defrost valves) permit to orient the two-phase refrigerant toward

the active evaporator and avoid flooding inactive ones.

The unit is equipped with a unit-mounted starter and control panel. Microprocessor based unit control modules provide accurate water control and providing monitoring, protection, and adaptive limit functions.

The adaptive nature of the controls intelligently prevents the unit from operating outside of its limits, or compensates for unusual operating conditions while keeping the unit running rather than simply shutting it off. If problems do occur, the Tracer Symbio™ 800 controls provide diagnostic messages to help the operator in troubleshooting.

Oil System

The oil is efficiently separated inside the scroll compressor and will remain in the scroll compressor during all run cycles. Between 1-2% of the oil circulates around with the refrigerant.

See Maintenance procedures section for oil level information.

Arbitration Rules

Tracer Symbio™ 800 provides the capability of switching circuit from a certain mode to another.

It arbitrates compressors to satisfy as much the cooling and heating demands from actual unit status.

The CMAF Multi-Pipe unit can operate several main settings of Capacity Control Priority that user can set:

1. **Cooling Only:** Runs unit as an air-sourced multi-pipe unit without heat recovery.
2. **Heating Only:** Runs unit as an air-sourced heat pump without heat recovery.
3. **Simultaneous Heating and Cooling:**
 - a. Heat recovery Priority: Factory default mode. If both demands are present, the heat recovery strategy is driven by the lowest demand. The best unit efficiency is achieved.
 - b. Max. capacity Priority: The heat recovery strategy is driven by the highest capacity demand. Suited for applications where heating and cooling demands need to be satisfied more quickly. This mode involves more frequent cycle changes.
 - c. Cooling Priority: When the unit runs in recovery mode and both demands are present, the recovery strategy is driven by cooling capacity demand.
 - d. Heating Priority: When the unit runs in recovery mode and both demands are present, the recovery strategy is driven by heating capacity demand.

CMAF refrigerant schematic

Detailed information for a given order is supplied with order package documentation.

Figure 17 - Example of Typical Refrigerant System Schematic

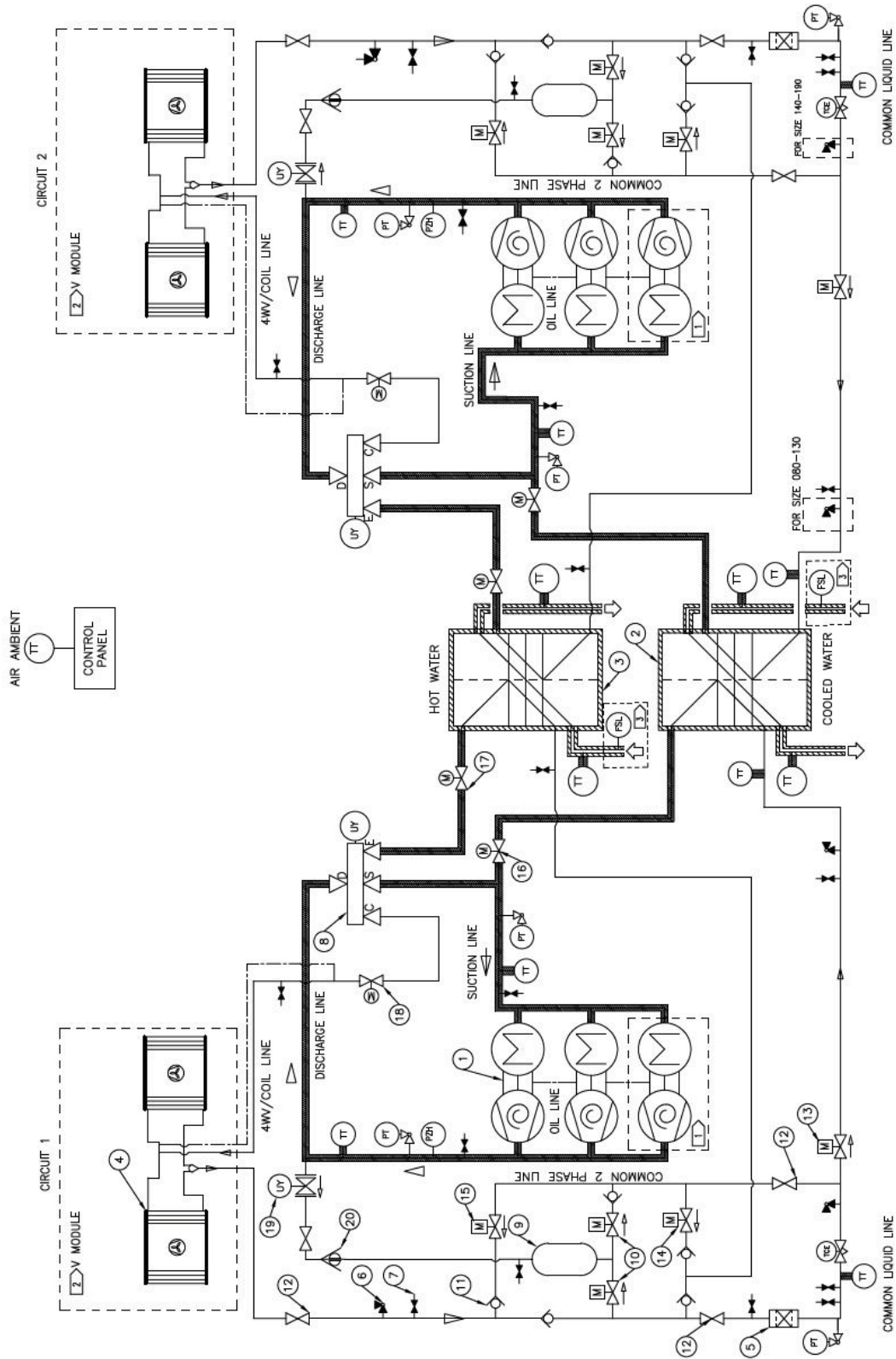

Figure 17 - Example of Typical Refrigerant System Schematic (Continued)

ITEM	DESIGNATION	DESCRIZIONE
1	SCROLL COMPRESSOR	COMPRESSORE SCROLL
2	EVAPORATOR (COOLED WATER)	EVAPORATORE
3	HEAT RECOVERY (HOT WATER)	RECUPERO
4	CONDENSER (AIR COOLED EXCHANGER)	BATTERIA AD ARIA
5	FILTER DRIER	FILTRO DISIDRATATORE
6	SERVICE VALVE	VALVOLA VUOTO- CARICA
7	PRESSURE TAP	VALVOLA SRHADER - PRESA SERVIZIO
8	4 WAY REVERSING VALVE	VALVOLA 4 VIE
9	RECEIVER	RICEVITORE DI LIQUIDO
10	FILL UP / DRAIN OUT VALVE	VALVOLA DI CARICO-SCARICO
11	CHECK VALVE	VALVOLA DI NON RITORNO
12	SERVICE ISOLATION VALVE	RUBINETTO
13	COOLING STEP MOTOR VALVE	VALVOLA PASSO PASSO FREDDO
14	DEFROST STEP MOTOR VALVE	VALVOLA PASSO PASSO DEFROST
15	H/P- STEP MOTOR VALVE	VALVOLA PASSO PASSO CHIELELR-POMPA
16	EVAPORATOR ISOLATION VALVE WITH ACTUATOR	RUBINETTO MOTORIZZATO EVAPORATORE
17	HR ISOLATION VALVE WITH ACTUATOR	RUBINETTO MOTORIZZATO RECUPERO
18	COIL ISOLATION VALVE WITH ACTUATOR	RUBINETTO MOTORIZZATO BATTERIE
19	HOT GAZ SOLENOID VALVE	SOLENOIDE HOT GAS
20	FLOATING RESTRICTOR	RESTRICTOR FLOTTANTE
21	EVAPORATOR OIL RETURN SOLENOID	SOLENOIDE RECUPERO OLIO

ITEM	DESIGNATION	DESCRIZIONE
PT	PRESSURE TRANSDUCER	TRASDUTTORE DI PRESSIONE
PZH	HIGH PRESSURE SWITCH	PRESSOSTATO DI ALTA
TT	TEMPERATURE SENSOR	SENSORE DI TEMPERATURA
TCE	ELECTRIC EXPANSION VALVE	VALVOLA ESPANSIONE ELETTRONICA
FSL	EVAPORATOR WATER FLOW SWITCH	FLUSSOSTATO EVAPORATORE
M	VALVE MOTOR	MOTORE VALVOLA
UY	SOLENOID	SOLENOIDE

————	REFRIGERANT LINE	REFRIGERANT LINE
- - - -	OIL LINE	LINEA OLIO
=====	CHILLED / HOT WATER LINE	ACQUA REFRIGERATA / ACQUA CALDA
///////	INSULATION	ISOLAMENTO

OPTIONS

3 FLOW SWITCH FSL

REFRIGERANT FLOW DIRECTION IS SHOWN FOR COOLING MODE

Operating Maps

CMAF Operating Maps

Figure 18 - Heat pump operating map

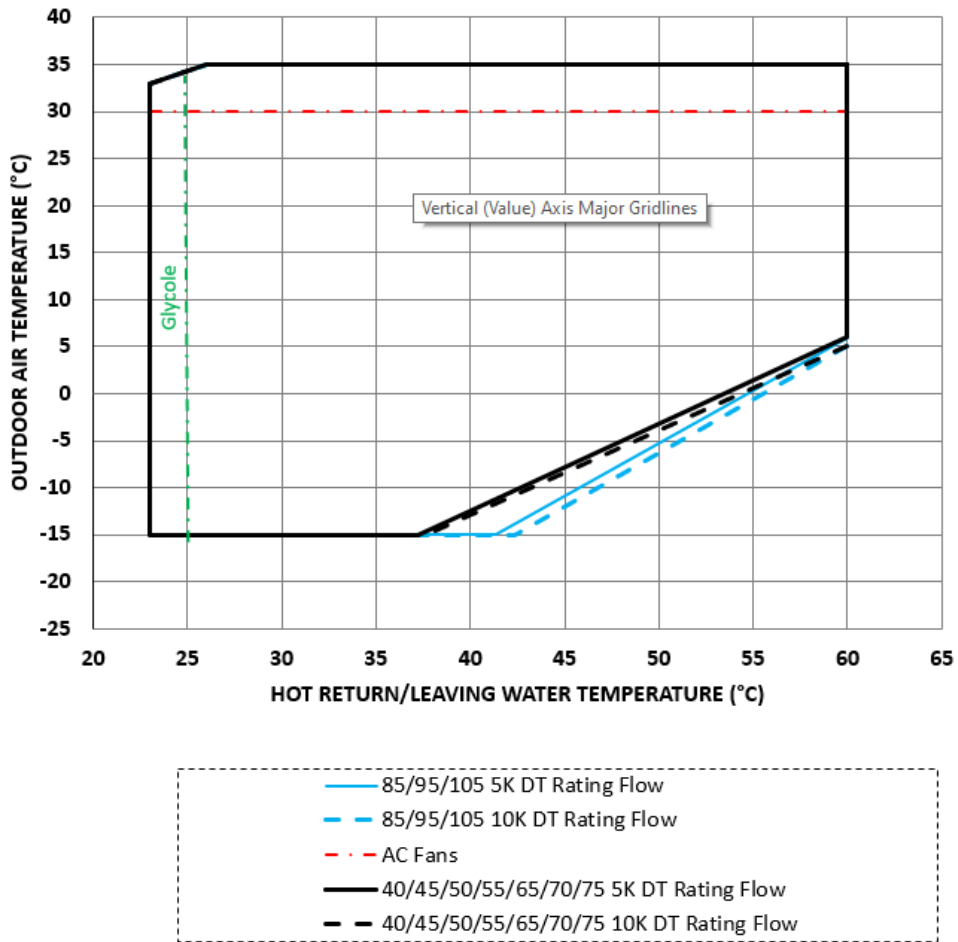

Figure 19 - Cooling operating map

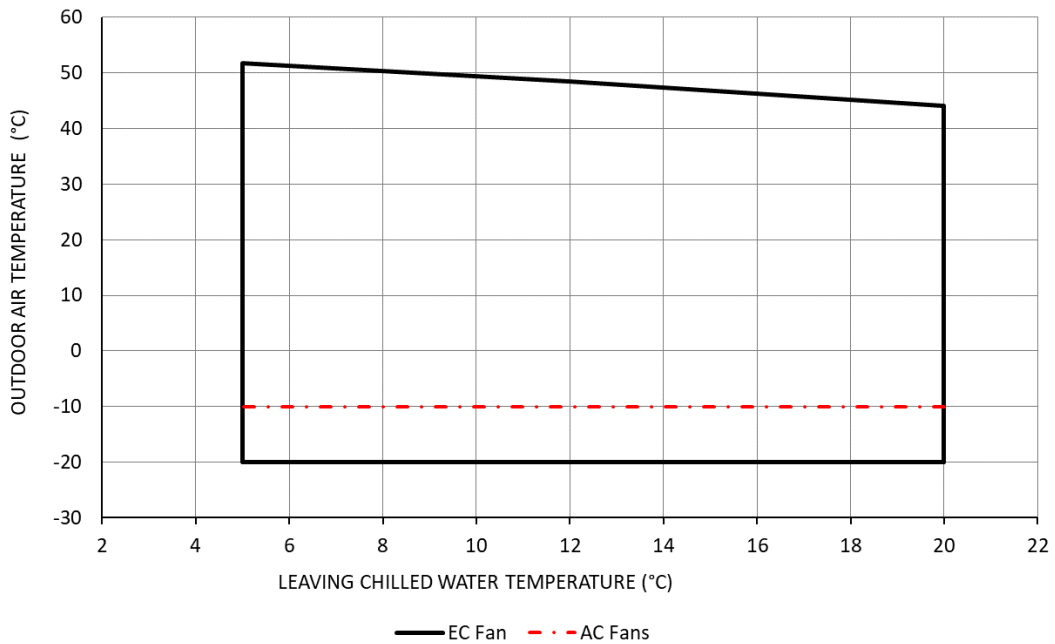
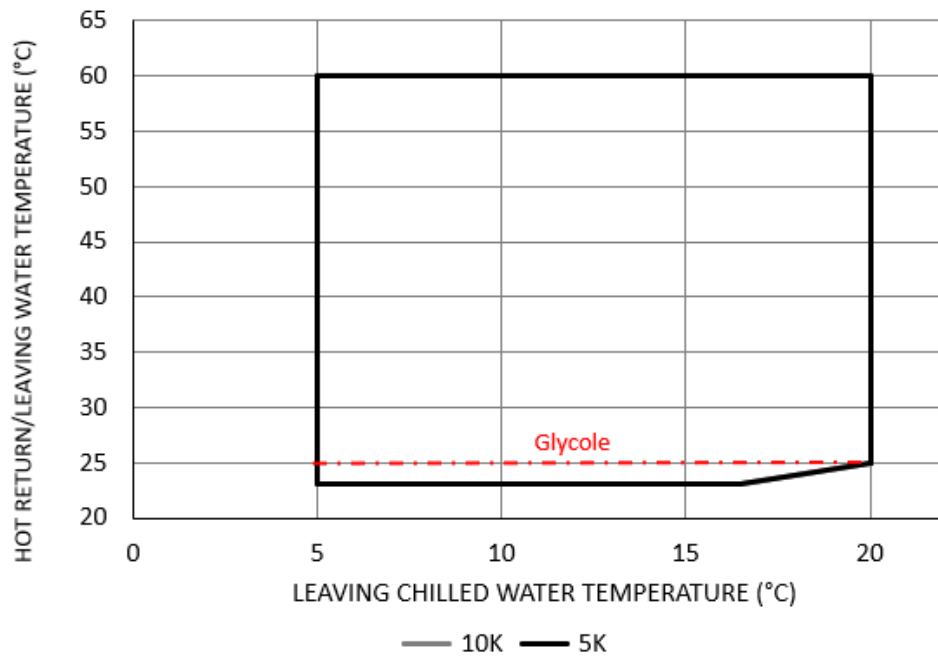

Figure 20 - Heat Recovery operating map



Notes:

Minimum start-up/operation at low ambient air temperature based on wind speed lower than 2m/s.

When the unit runs the Cooling / Heat Pump mode on a circuit and the heat recovery mode on the other the hot leaving temperature is limited to the heat pump operating map, and the chilled leaving temperature is limited to the cooling operating map.



Controls/Tracer TD7 Operator Interface

Controls Overview

Units use the following control/interface components:

- Symbio™ Controller
- TracerTD7 Operator Interface

Communication Interfaces

There are four connections on the Symbio™ that support the communication interface. See CMAF User Guide to locate the following ports: “Wiring and Ports Description” section.

- BACnet MS/TP and BACnet IP
- MODBUS RTU (Slave) and ModbusTCP (Slave)

See User Guide for information on communication interface.

Tracer TD7 Operator Interface

Information is tailored to operators, service technicians and owners. When operating a unit, there is specific information you need on a day-to-day basis, like setpoints, limits, diagnostic information, and reports.

Day-to-day operational information is presented at the display. Logically organized groups of information- unit mode of operation, active diagnostics, settings and reports put information conveniently at your fingertips.

Tracer™TU

The TD7 operator interface allows for daily operation tasks and set point changes. However, to adequately service units, Tracer™TU service tool is required (non-Trane personnel, contact your local Trane office for software purchase information). Tracer™ TU adds a level of sophistication that improves service technician effectiveness and minimizes unit downtime. This portable PC-based service-tool software supports service and maintenance tasks.

Tracer™TU Set-Up

Using Tracer™TU service tool, adjust the settings. Refer to Tracer™TU manual and Tracer Symbio™ 800 user guide for instruction on settings.

CAUTION! To prevent compressor damage, do not operate the unit until all refrigerant valves and oil-line service valves are opened.

IMPORTANT! A clear sight glass alone does not mean that the system is properly charged. Also check system discharge superheat, approach temperature and unit operating pressures.

Pre-Start Checkout

Installation Checklist

Complete this checklist when the unit is installed and verify that all recommended procedures are accomplished before the unit is started. This checklist does not replace the detailed instructions given in the “Installation Mechanical” and “Installation Electrical” sections of this manual. Read both sections completely, to become familiar with the installation procedures, prior beginning the work.

General

When installation is complete, before starting the unit, the following prestart procedures must be reviewed and verified:

Caution: Follow proper lockout/tagout procedures to ensure the power cannot be inadvertently energized. Failure to disconnect power before servicing could result in death or serious injury.

WARNING Live Electrical Components!

During installation, testing, servicing, and troubleshooting of this product, it may be necessary to work with live electrical components. Have a qualified licensed electrician or other individual who has been properly trained in handling live electrical components perform these tasks. Failure to follow all electrical safety precautions when exposed to live electrical components could result in death or serious injury.

1. Inspect all wiring connections in the compressor power circuits (disconnects, terminal block, contactors, compressor junction box terminals and so forth) to ensure they are clean and tight.

Verify that all refrigerant valves in the discharge, liquid, and oil return lines are “OPEN”.

Check the power-supply voltage to the unit at the main-power fused-disconnect switch. Voltage must be within the voltage use range and stamped on the unit nameplate. Voltage fluctuation must not exceed 10%. Voltage imbalance must not exceed 2%

Check the unit power phasing L1-L2-L3 in the starter to ensure that it has been installed in a “A-B-C” phase sequence.

Fill the evaporator chilled-water circuit. Vent the system while it is being filled. Open the vents on the top of the water exchangers during filling and close when filling is completed.

Close the fused-disconnect switch(es) that supplies power to the chilled/hot water pump starter.

Start the chilled-water pump to begin circulation of the water. Inspect all piping for leakage and make any necessary repairs.

With water circulating through the system, adjust the water flow and check the water pressure drop through the water exchangers.

Adjust the chilled-water flow switch for proper operation.

Reapply power to complete the procedures

Prove all Interlock and Interconnecting Wiring Interlock and External as described in the Electrical Installation section.

Check and set, as required, all Symbio™TD7 menu items.

Stop the water pumps.

Energize the compressor and oil separator heaters 24 hours, prior to unit start up

Unit Voltage Power Supply

Unit voltage must meet the criteria given in the installation Electrical Section. Measure each lead of the supply voltage at the main power fused-disconnect switch for the unit. If the measured voltage on any lead is not within the specified range, notify the supplier of the power and correct the situation before operating the unit.

Unit Voltage Imbalance

Excessive voltage imbalance between the phases of a three-phase system can cause motors to overheat and eventually fail. The maximum allowable unbalance is 2%. Voltage imbalance is determined using the following calculations:

$$\% \text{ Imbalance} = [(V_x - V_{ave}) \times 100 / V_{ave}] V_{ave}$$

$$= (V_1 + V_2 + V_3) / 3$$

V_x = phase with greatest difference from *V_{ave}* (without regard to the sign)

Unit Voltage Phasing

It is important that proper rotation of the compressors be established before the unit is started. Proper motor rotation requires confirmation of the electrical phase sequence of the power supply. The motor is internally connected for clockwise rotation with the incoming power supply phases A-B-C.

When rotation is clockwise, the phase sequence is usually called “ABC”, when counterclockwise “CBA”

This direction may be reversed by interchanging any two of the line wires.

1. Stop the unit from TD7/Symbio™800.

Open the electrical disconnect or circuit protection switch that provides line power to the line power terminal block(s) in the starter panel (or to the unit mounted disconnect).

Connect the phase-sequence indicator leads to the line power terminal block (L1-L2-L3).

Turn power on by closing the unit supply-power fused-disconnect switch.

Read the phase sequence on the indicator. The ABC LED of the phase indicator will glow.

WARNING! It is imperative that L1, L2, and L3 in the starter be connected in the A-BC phase sequence to prevent equipment damage due to reverse rotation.



WARNING! To prevent injury or death due to electrocution, take extreme care when performing service procedures with electrical power energized.

CAUTION! Do not interchange any load leads that are from the unit contactors or the motor terminals. Doing so may damage the equipment.

Water System Flow Rates

Establish a balanced chilled/hot water flow through the water exchangers. The flow rates should be between the minimum and maximum values given on the pressure drop curves.

Water System Pressure Drop

Measure the water-pressure drop through the water exchangers on the field installed pressure taps on the system water piping. Use the same gauge for each measurement. Do not include valves, strainers, or fittings in the pressure drop readings.

Integrated Pump Package (Optional)

Before starting up the pump, the pipe system must be thoroughly cleaned, flushed, and filled with clean water. Do not start the pump until it has been vented.

CAUTION! When using freeze inhibitor, never fill the system with pure glycol; this will damage the shaft seal. Always fill the system with diluted solution. Maximum concentration of glycol is 40% for unit with pump package.

CAUTION!

Failure to operate pump w/o water or insert high glycol concentration will lead to premature seal damage and void the warranty.

Figure 21 - Typical integrated chilled water pump

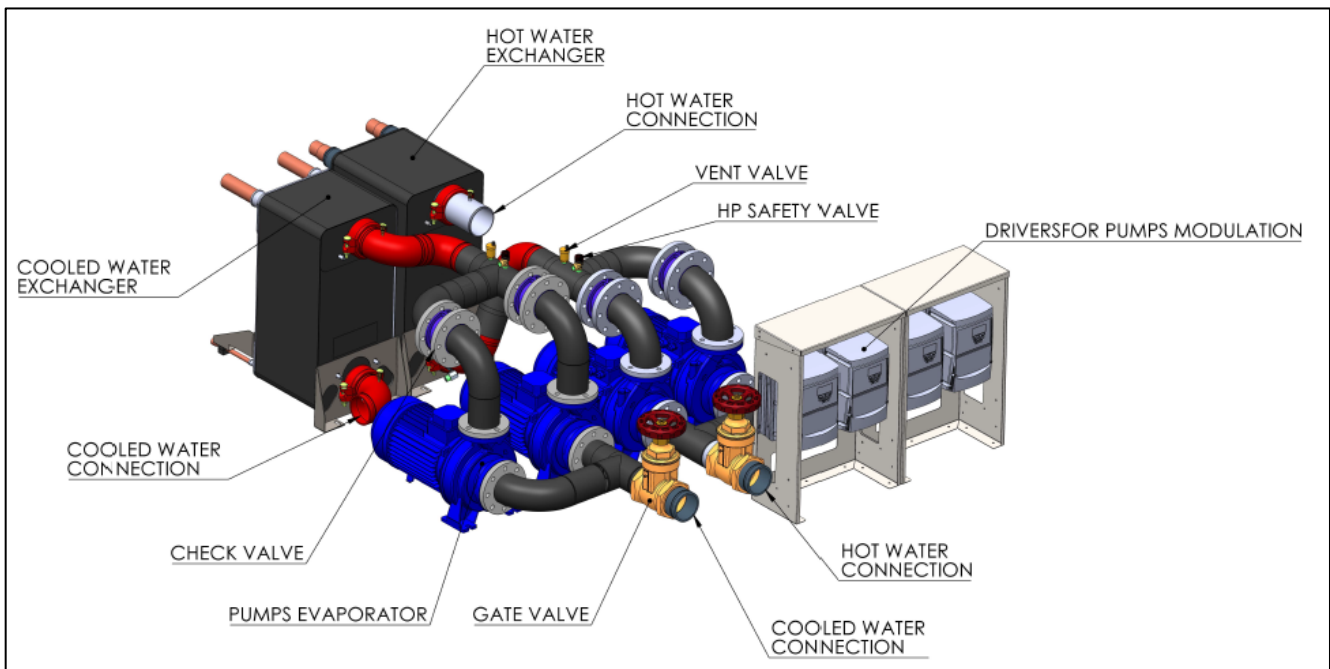

Unit Start Up Procedures

Daily Unit Start Up

The timeline for the sequence of operation begins with a power-up of the main power to the unit. The sequence assumes 2 circuits, 2 compressors, unit with no diagnostics or malfunctioning components. External events such as the operator placing the unit in AUTO or STOP, chilled/hot water flow through the water exchangers, and application of load to the water loop causing loop water-temperature increases, are depicted and the unit responses to those events are shown, with appropriatedelays noted. The effects of diagnostics, and other external interlocks other than water flow proving, are notconsidered.

Note: unless the Tracer Symbio™ 800 and building automation, system is controlling the chilled-water pump, the manual unit start sequence is as follows. Operator actions are noted.

General

If the present checkout, as discussed above, has been completed, the unit is ready to start.

1. Press the STOP key on the TD7 display.
2. As necessary, adjust the set point values on the TD7 menus using Tracer™ TU.
3. Close the fused-disconnect switch for the chilled-water pump. Energize the pump(s) to start water circulation
4. Check the service valves on the discharge line, suction line, oil line, and liquid line for each circuit. These valves must be open (back seated) before starting the compressors.
5. Verify that chilled-water pump runs for at least one minute after the unit is commanded to stop (for normal chilled-water systems).
6. Press the AUTO key. If the unit control calls for cooling / heating, and all safety interlocks are closed, the unit will start. The compressor(s) will load and unload in response to the leaving water temperature.

After the system has been operating for approximately 30 minutes and has become stabilized, complete the remaining start up procedures, as follows:

1. Check the suction, discharge, and liquid refrigerant pressures under Refrigerant Report on the TD7.

Check the EXV sight glasses after enough time has elapsed to stabilize the unit. The refrigerant flow through the sight glasses should be clear. Bubbles in the refrigerant indicate either low refrigerant charge or excessive pressure drop in the liquid line, or an expansion valve that is stuck open. A restriction in the line can sometimes be identified by a noticeable temperature differential between the two sides of the restriction. Frost will often form on the line at this point. Proper refrigerant charges are shown in the General Information Section.

Seasonal Unit Startup Procedure

1. Close all valves and reinstall the drain plugs in the Chilled/Hot Water Exchangers.
2. Service the auxiliary equipment according to the startup and maintenance instructions provided by the respective equipment manufacturers.
3. Close the vents in chilled / hot water circuits.
4. Open all the valves in the chilled / hot water circuits.
5. Open all refrigerant valves.
6. If the water exchangers were previously drained, vent and fill chilled / hot water circuits. When all air is removed from the system (including each pass), install the vent plugs on water pipes.
7. Check the adjustment and operation of each safety and operating control.
8. Close all disconnect switches.
9. Refer to the sequence for daily unit start up for the remainder of the seasonal start up.
10. Clean up the flow switches and adjust their setting if necessary. Care to orient them to face up the water flow correctly.
11. Check proper functioning of isolation valves. Make sure nuts between valve and actuator are still tightened enough (40 N.m)

CAUTION! Ensure that the compressor and heaters have been operating for a minimum of 24 hours before starting. Failure to do so may result in equipment damage

System Restart after Extended Shutdown

1. Verify that the liquid-line service valves, compressor discharge service valves, and optional suction service valves are open (back seated).
2. Check the oil level (see Maintenance procedures section).
3. Fill the chilled/hot water circuits. Vent the system while it is being filled. Open the vent on the top of the chilled/hot water exchanger while filling and close it when filling is completed.
4. Close the fused-disconnect switches that provide power to water pumps.
5. Start water pumps and, while water is circulating, inspect all piping for leakage. Make any necessary repairs before starting the unit.
6. While the water is circulating, adjust the water flow and check the water pressure drops through the chilled/hot water exchanger. Refer to “water-system flow rates” and “water-system pressure drops”.
7. Clean up the flow switches and adjust their setting if necessary. Care to orient them to face up the water flow correctly.
8. Stop the water pumps. The unit is now ready for startup as described “Startup procedures”.

CAUTION! To prevent damage to the compressor, ensure that all manual refrigerant valves are open before starting the unit. Do not use untreated or improperly treated water. Equipment damage may occur.



Temporary Shutdown and Restart

Temporary Shutdown is used for control operation, maintenance or to repair the unit typically less than one week.

To shut the unit down for a short time, use the following procedure:

1. Press the STOP key on the TD7. The compressors will stop when the compressor contactors de-energize.
2. Stop the water circulation by turning off water pumps at least one minute after the stop of the compressors.

To restart the unit after a temporary shutdown, enable the chilled-water pump and press the AUTO key.

The unit will start normally, provided the following conditions exist:

- The Tracer Symbio™ 800 receives a call for cooling / heating and the differential-to-start is above the set point.
- All system operating interlocks and safety circuits are satisfied.

CAUTION! Under freezing conditions, water pumps of chilled/hot water exchangers must remain in operation during the full shutdown period of the unit if their water loop does not contain glycol to prevent any risk of freeze-up.

Extended Shutdown Procedure

The following procedure is to be followed if the system is to be taken out of service for an extended period (i.e., seasonal shutdown):

1. Test the unit for refrigerant leaks and repair as necessary.
2. Open the electrical disconnect switches for water pumps. Lock the switches in the "OPEN" position.
3. Close all water supply valves. Drain the water from the water exchangers.
4. Open the unit main electrical disconnect and unit-mounted disconnect (if installed) and lock in the "OPEN" position.
5. At least every three months (quarterly), check the refrigerant pressure in the unit to verify the refrigerant charge integrity.

CAUTION! Lock water pump disconnects open to prevent pump damage. Lock the disconnect switch in the "OPEN" position to prevent accidental startup and damage to the system when it has been set up for extended shutdown. During an extended shutdown period, especially over the winter season, the chilled/hot water exchangers must be drained of water, if the chilled water loop does not contain glycol, to prevent any risk of water exchanger freeze-up.

Periodic Maintenance

General

Perform all maintenance procedures and inspections at the recommended intervals. This will increase the life of the unit and minimize the possibility of serious and costly breakdown.

Use an "Operator's Log" to record the unit's operating history. The log serves as a valuable diagnostic tool for service personnel. By observing trends in operating conditions, an operator can anticipate and prevent problem situations before they occur. If the unit is not operating properly during maintenance inspections, consult the "Diagnostic and Troubleshooting" section of this manual. Proper servicing of the service valves is required. Use a backup wrench as shown in Figure when loosening or tightening the service valve cap.

Figure 23 - Servicing of service valves

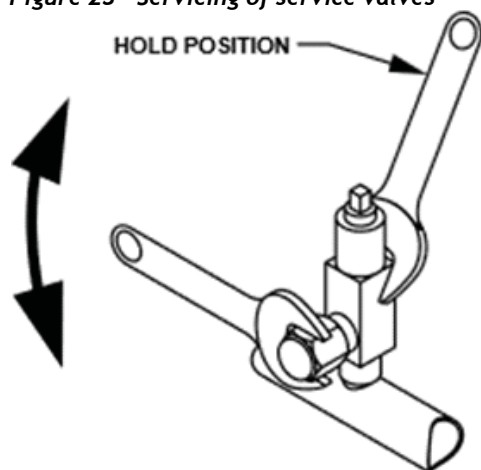

Weekly Maintenance

After the unit has been operating for approximately 30 minutes and the system has stabilized, check the operating conditions, and complete the procedures below:

1. Check on the TD7 pressure for chilled/hot water exchangers, and intermediate oil.
Note: Pressures are referenced at sea level.
2. Inspect the entire system for unusual conditions and inspect the condenser coils for dirt and debris. If the coils are dirty, refer to coil cleaning.

Check the electronic expansion valve sight glasses.

Note: The electronic expansion valve is commanded closed at unit shutdown and if the unit is off, there will be no refrigerant flow through the sight glasses. Only when a circuit is running will refrigerant flow be present. The refrigerant flow through the sight glasses should be clear. Bubbles in the refrigerant indicate either low refrigerant charge or excessive pressure drop in the liquid line. A restriction in the line can sometimes be identified by a noticeable temperature differential between the two sides of the restriction. Frost may often form on the liquid line at this point. Correct refrigerant charges is shown in nameplate.

NOTICE: A clear sight glass alone does not mean that the system is properly charged. Also check the system superheat, subcooling and unit operating pressures.

NOTICE: Use only manifold gauge sets designed for use with R410A refrigerant.

Use only recovery units and cylinders designed for the higher pressure of R410A refrigerant and POE oil.

NOTICE: R410A must be charged in a liquid state.

Check the system superheat, subcooling, chilled/hot water exchanger temperature drop (Delta-T), water flow rates, approach temperatures, compressor discharge superheat, and compressor RLA.

Normal operating conditions are:

Table 12 - Typical approaches / pressures

	Cooling mode	Heat pump mode	Heat Recovery Mode
Typical Air Temperature	35 °C	7 °C	whatever
Typical leaving water temperature	7 °C	45 °C	7 / 45 °C
Suction approach	3 to 5 K	8 to 12 K	3 to 5 K
"Discharge approach with: - approx. 5K water delta T - approx. 10K water delta T"	"14 to 20 K"	"0 to 2 K -3 to -1 K"	"0 to 2 K -3 to -1 K"
Compressor Suction Superheat	5 to 6 K		
EXV Liquid Subcooling	4 to 6 K		
EXV opening	55 to 65%	50 to 60%	60 to 70%

Note: CMAF is common with service valves, ensure the re-opening of them (Item 12 in Refrigerant system schematic & Oil lube circuit schematic) after refrigerant transfer.

Note: If the superheat is unstable, check the suction temperature sensor. The sensor should be well inserted into the well and thermal grease should be used to ensure a good contact between the sensor and the well. The sensor must be wrapped with insulation as well.

If operating pressures and sight glass conditions seem to indicate a refrigerant shortage, measure the system superheat and subcooling. Make sure the drain valve is well open.

Note: If the subcooling is unstable, check the liquid temperature sensor. The sensor shall be well inserted into the well and thermal grease shall be used to ensure a good contact between the sensor and the well. The sensor must be wrapped with insulation as well.

If operating conditions indicate a refrigerant overcharge, make sure the fill up valve is well open, remove refrigerant at the liquid line service valve.

Allow refrigerant to escape slowly to minimize oil loss. Use a refrigerant recovery cylinder and do not discharge refrigerant into the atmosphere.

WARNING! Do not allow refrigerant to directly contact skin as injury from frostbite may result.



Monthly Maintenance

1. Perform all weekly maintenance procedures.
2. Manually rotate the condenser fans to ensure that there is proper clearance on the fan shroud openings.
3. Check water pumps (option): Manually rotate the pump. Remove plastic plug located at the bottom of the motor frame to drain any condensation which can occur in the motor.
4. Check and clean air filter of the control panel (option).
5. In case of Twin-pump, make sure there is no pump motor fault.

Note: Pump operation will be alternated at each new request of water flow or when a pump fault is detected.

WARNING! Position all electrical disconnects in the "OPEN" position and lock them to prevent injury of death due to electrical shock or moving parts.

When electrical panels are ventilated, you need to change the fan filter.

6. Make any repairs necessary.

Annual Maintenance

1. Perform all weekly and monthly procedures.
2. Check the oil sump oil level and refrigerant charge while the unit is off.

Note: Routine changing of the oil is not required. Make an oil analysis to determine the condition of the oil.

1. Have TRANE or another qualified laboratory perform a compressor oil analysis to determine system moisture content and acid level. This analysis is a valuable diagnostic tool.

Contact a qualified service organization to leak-test the unit, to check operating and safety controls, and to inspect electrical components for deficiencies.

Inspect all piping components for leakage and damage.

Clean all water strainers.

NOTICE: If the unit Chilled/Hot Water Exchanger are drained of water, the freeze protection heater must be de-energized. Failure to de-energize the heater might cause it to burn out.

Clean and repaint any areas that show signs of corrosion.

Clean the condenser coils.

Check and tighten all electrical connections as necessary.

CAUTION! A clear sight glass alone does not mean that the system is properly charged. Also check the rest of the system operating conditions.

WARNING! Position all electrical disconnects in the "Open" position and lock them to prevent injury or death due to electrical shock.

Clean the condenser fans. Check the fan assemblies for proper clearance in the fan shroud openings and for motor shaft misalignment or abnormal endplay, vibration and noise.

Refrigerant Emission Control

Conservation and emission reduction can be accomplished by following recommended Trane operation, maintenance, and service procedures, with specific attention to the following:

1. Refrigerant used in any type of air-conditioning or refrigerating equipment should be recovered and/or recycled for reuse, reprocessed (reclaimed). Never release refrigerant into the atmosphere.
2. Always determine possible recycle or reclaim requirements of the recovered refrigerant before beginning recovery by any method.
3. Use approved containment vessels and safety standards. Comply with all applicable transportation standards when shipping refrigerant containers.
4. To minimize emissions while recovering refrigerant, use recycling equipment. Always attempt to use methods that will pull the lowest possible vacuum while recovering and condensing refrigerant into containment.
5. Refrigerant-system cleanup methods that use filters and dryers are preferred. Do not use solvents that have ozone depletion factors. Properly dispose of used materials.
6. Take extra care to properly maintain all service equipment that directly supports refrigeration service work, such as gauges, hoses, vacuum pumps, and recycling equipment.
7. Stay aware of unit enhancements, conversion refrigerants, compatible parts, and manufacturer's recommendations that will reduce refrigerant emissions and increase equipment operating efficiencies. Follow the manufacturer's specific guidelines for conversion of existing system.
8. To assist in reducing power-generation emissions, always attempt to improve equipment performances with improved maintenance and operations that will help conserve energy resources.

Refrigerant and Oil-charge Management

Proper oil and refrigerant charge are essential for proper unit operation, unit performances, and environmental protection. Only trained and licensed service personnel should service the unit.

Some of the symptoms of a refrigerant under-charged unit:

- Larger-than-normal evaporator approach temperatures (leaving water temperature - saturated evaporator temperature). If the refrigerant charge is correct the approach temperature is 4 °C. These values are given for units running at full load and with water without antifreeze
- Low Evaporator-refrigerant temperature limit
- Low Refrigerant-Temperature cutout diagnostic
- Fully open expansion valve
- Possible whistling sound coming from liquid line (due to high vapor velocity)
- High coil condenser pressure drops
- Receiver drain valve remains opens

Some of the symptoms of a refrigerant over-charged unit

- Condenser Pressure Limit
- High -Pressure Cutout diagnostic
- More-than-normal number of fans running
- Erratic fan control
- Higher-than-normal compressor power
- Receivers fill up valve remains open

Some of the symptoms of an oil over-charged unit

- Larger-than-normal evaporator approach temperatures (Leaving-water-temperature - Saturated Evaporator Temperature)
- Low Evaporator-refrigerant Temperature limit
- Low Refrigerant - Temperature Cutout diagnostic
- Low unit capacity
- High oil-sump level after normal shutdown
- Low compressor discharge temperature

Some of the symptoms of an oil under-charged unit

- Seized or Welded compressors
- Low oil-sump level after normal shutdown



Compressor Service Information

Compressor Electrical Connections

It is very important that DSH compressors used in the unit are wired correctly for proper rotation. These compressors will not tolerate reverse rotation. Verify correct rotation/phasing using a rotation meter.

Proper phasing is clockwise, A-B-C. If wired incorrectly a DSH compressor will make excessive noise, will not pump and will draw about half the normal current. It will also become very hot if allowed to run for an extended period.

Notice: Do not “bump” the compressor to check rotation as incorrect rotation could cause compressor motor failure in as little as 4 to 5 seconds!

Oil Level

To check compressor oil level, refer to the label near the compressor sight glass. The compressor(s) must be off. Wait three minutes. With tandem or trio compressors the oil level will equalize after shutdown. Compressor oil level should be no lower than the bottom of the sight glass and no more than a full sight glass. When operating, each compressor in a tandem or trio set may have a different oil level. The oil level may not be in the sight glass, but it must be visible through the sight glass.

Oil Fill, Removal and Capacity

The DSH scroll compressors have an oil charging valve with a dip tube that goes to the bottom of the compressor. This can be used to add or remove oil from the compressor.

Care must be taken to prevent moisture from entering the systems when adding oil. Note that the POE oil used in this product is very hygroscopic and easily absorbs and retains moisture. Moisture is very difficult to remove from oil using vacuum. Also note that once the seal on a container of POE oil is opened, the oil must be used.

Use only Trane OIL00057E (3.8 l) or OIL00058E (18.9 l). These are the same oil but different container size. Do not use any other POE oil.

NOTE: Never reuse oil.

Oil Testing

We recommend performing a complete oil analysis at least once a year with the Trane laboratory specifically dedicated to oil analysis for Trane equipment. It provides an in-depth view of both compressor and refrigerant circuit conditions including presence of water, wear particles, viscosity, acidity, or dielectric data. If unacceptable wear conditions develop, a change in the characteristics of the oil will be evident. Minor problems can be detected and repaired before they become major problems.

Oil Equalizer Line

Scroll Compressors

The oil equalizer line is equipped with a Rotolock fitting for easy removal. Torque value for tightening these fitting is 145 N.m. Recover the system refrigerant charge and drain the oil to a level below the oil equalizer tube fitting before removing the oil equalizer line. This must be done on both compressors. Use the oil drain valve on the compressor. If the oil is drained below the level of the oil level sight glass, it will be below the oil equalizer line level. Pressurize the low side of the compressor using nitrogen to help drain the oil. No more than 70 kPa of pressure will be needed.

Tandem and Trio Compressor Suction Restrictors

Since most tandem and trio compressor sets use unequal size compressors, these combinations require the use of a restrictor in the suction line of one or more compressors to provide correct oil level balance between compressors when they are operating.

Compressor Replacement

If the unit suffers from a failed compressor, use these steps for replacement:

Each compressor has lifting eyes. Both lifting eyes must be used to lift the failed compressor. **DO NOT LIFT A COMPRESSOR USING A SINGLE LIFTING EYE.** Use proper lifting techniques, a spreader bar and rigging as for lifting both compressors simultaneously.

After a mechanical failure of a compressor, it is necessary to change the oil in the remaining compressor and also replace the liquid line filter drier. After an electrical failure of a compressor, it will also be necessary to change the oil in the remaining compressor, replace the liquid line filter drier and add a suction filter drier with clean-up cores.

Note: Do not alter the refrigerant piping in any way as this can affect compressor lubrication.

Refrigerant System Open Time

Units use POE oil and therefore refrigerant system open time must be kept to a minimum. The following procedure is recommended:

- Leave a new compressor sealed until it is ready to be installed in the unit. Maximum system open time is dependent upon ambient conditions, but do not exceed one-hour open time.
- Plug the open refrigerant line to minimize moisture absorption. Always change the liquid line filter drier.
- Evacuate the system to 500 microns or below. Do not leave POE oil containers open to the atmosphere. Always keep them sealed.

Mechanical Compressor Failure

Replace the failed compressor(s) and change the oil in the remaining compressor(s) along with the refrigerant system liquid line filter drier.

Electrical Compressor Failure

Replace the failed compressor and change the oil in the other compressor(s). Also add a suction filter with cleanup cores and change the liquid line filter drier.

Change filters and oil until the oil no longer test acidic. See "Oil Testing."

Compressor Motor Megging

Motor megging determines the electrical integrity of the compressor motor winding insulation. Use a 500-volt megger. A less than 1 meg-ohm reading is acceptable and 1000 ohms per nameplate volts is required to safely start the compressor.

Compressor Current Imbalance

Normal current imbalance could be 4 to 15 percent with balanced voltage due to motor design. Each phase should register 0.3 to 1.0 ohms and each phase should be within 7 percent of the other two phases. Phase to ground resistance must be infinity.

NOTICE: Maximum allowable voltage imbalance is 2 percent.

Compressor Electrical Terminal Box

Be sure to protect the terminal box when unbracing or brazing compressor refrigerant piping connections.

Compressor Crankcase Heaters

Compressor crankcase heaters must be energized at least eight hours before starting the unit. This is required to boil refrigerant out of the oil before startup. Ambient temperature is not a factor, and the crankcase heaters must always be energized prior to startup.

Refrigerant Piping

The compressor suction and discharge connections and piping are copper clad steel for easy brazing. In most instances, piping may be reused. If piping is not reusable, order the correct service parts. Cut all tubing with a tubing cutter to prevent copper filings from entering the system. Cut the tubing in a straight length of pipe after the compressor connection has been unsweated. The line can then be reinstalled using a slip coupling and brazing.

NOTICE: The compressor suction line configuration must not be changed in any way. Changing compressor suction line configuration will compromise proper oil return to the compressor(s).

Integrated Pump Maintenance

Water Pump Maintenance

WARNING! Before starting work on the pump, make sure that the power supply has been switched off and that it cannot be accidentally switched on.

CAUTION! The lifting eyebolts of the motor are suitable for the weight of the motor only. It is not allowed to carry the complete pump on the lifting eyebolts of the motor.

It is important to keep the motor clean to ensure adequate cooling of the motor. If the pump is installed in dusty environments, it must be cleaned and checked regularly. Take the enclosure class of the motor into account when cleaning.

If the water loop must be emptied during period of frost, the pump must be drained to avoid damage. Remove the filling and drain plugs. Do not refit the plugs until the pump is taken into operation again.

Lubrication

The motor bearings of hot water pumps are greased for life and require no lubrication as well as bearings of chilled water pump motors 5.5kW and 7.5kW. Increasing bearing noise and undue vibration indicate a worn bearing. The bearing or the complete motor then needs replacement.

Bearings of chilled water pump motors 11kW and over must be greased every 4000 hours or at yearly service. The required grease quantity is 10g per bearing. The motor must run during lubrication. Use lithium-based grease.

The pump shaft seal does not require any special maintenance. Visual leakage check is however required. Distinctly visible leakage will require an exchange of the seal.

For further details about pump maintenance please consult the pump supplier website.

Figure 24 - Motor bearings

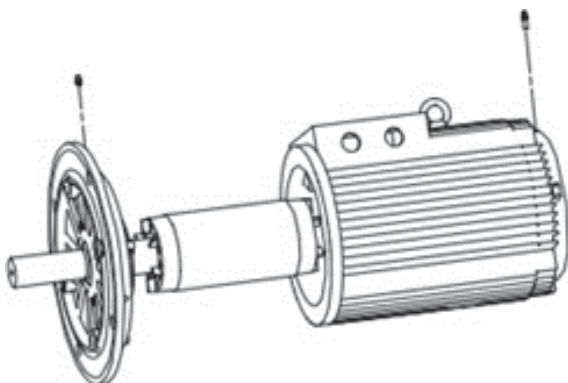

Exchanger Maintenance

Coil Condenser Maintenance

Clean the condenser coils at least once a year or more frequently if the unit is in a “dirty” environment. A clean condenser coil will help to maintain unit operating efficiency. Follow the detergent manufacturer’s instructions to avoid damaging the condenser coils.

Remove whole sentence “Black epoxy coil protection (option).

It is recommended to clean the coils at unit start-up and regularly to obtain optimum protection and life span of the condenser coils. To clean the condenser coils, use a soft brush and a sprayer such as a garden pump type ora high-pressure type. A high-quality detergent such as Trane Coil Cleaner is recommended.

Note: If detergent mixture is strongly alkaline (pH value greater than 8 .5), an inhibitor must be added.

BPHE Maintenance

The unit uses brazed plate heat exchangers (BPHE) with factory installed flowswitch that is positioned on the inlet water pipe. The exchanger inlets must also include a water strainer that must be kept in place to keep debris out of the plates.

Note: Strainer maintenance is critical to proper operation and reliability. Any particles larger than 1.6 mm entering the BPHE may cause strong damage, requiring replacement.

BPHE exchangers are difficult to clean if clogged with debris. Indications of a plugged BPHE exchanger includes “wet” suction due to lack of heat exchange, loss of superheat control, discharge superheat less than 35 K, compressor oil dilution and/or starvation and premature compressor failure.

BPHE replacement

If the BPHE chilled/hot water exchangers require replacement, it is very important that the new exchanger shall be replaced correctly and with the correct refrigerant and water piping connections. The refrigerant liquid connection is at the bottom of the exchanger and the refrigerant gas outlet connection is at the top of the exchanger and both are on the same face. Pay particular attention because they are dual circuits. Avoid cross-circuiting when installing the new exchanger.



Log Check Sheet

The operator log sheet are included for use as appropriate, for installation completion verification before Trane Start-up is scheduled, and for reference during the Trane Start-up.

Operator Log								
Sintesis™ Balance CMAF Multi-Pipe Unit with Tracer Symbio™ 800 Controller - Tracer AdaptiView								
Reports - Log Sheet								
	Start		15 minutes		30 minutes		1 hour	
	Ckt 1	Ckt 2	Ckt 1	Ckt 2	Ckt 1	Ckt 2	Ckt 1	Ckt 2
Circuit Operating Mode (Cooling / Heat Pump / Heat Recovery)								
EXV Opening (%)								
Coil Condenser								
Outdoor Temperature								
Air flow (%)								
Compressor Manifold								
Saturated Suction Temperature (°C)								
Saturated Discharge Temperature (°C)								
Discharge Temperature (°C)								
Active Suction Superheat Setpoint (°C)								
Suction Superheat (°C)								
Compressor Running Status No1								
Compressor Running Status No2								
Compressor Running Status No3								
Chilled water exchanger								
Active Chilled Water Setpoint								
Entering Water Temperature								
Leaving Water Temperature								
Water flow Status								
Approach Temperature (°C)								
Hot water exchanger								
Active Hot Water Setpoint								
Entering Water Temperature								
Leaving Water Temperature								
Water flow Status								
Refrigerant Pressure (kPa)								
Approach Temperature (°C)								
Receiver								
Saturated Liquid temperature								
Active Subcooling Setpoint (°C)								
Subcooling (°C)								
Drain Valve Opening (%)								
Fill Up Valve Opening (%)								

Date:
Technician:
Owner:

Recommended service routine frequencies



As a commitment to our customers, we have created a wide service network staffed with experienced factory- authorized technicians. At Trane we offer all the benefits of after sales service direct from the manufacturer and we are committed to our mission statement to provide efficient customer care.

Year	Commis- sioning	Inspec- tion visit	Seasonal shut down	Seasonal start up	Oil analysis (2)	Vibration analysis (3)	Annual mainte- nance	Preven- tive mainte- nance	Tube analysis (1)	Com- pressor R'newal (4)
1	x	x	x	x		x		xxx		
2			x	x	x		x	xxx		
3			x	x	x		x	xxx		
4			x	x	x		x	xxx		
5			x	x	x	x	x	xxx	x	
6			x	x	x	x	x	xxx		
7			x	x	x	x	x	xxx		
8			x	x	x	x	x	xxx		
9			x	x	x	x	x	xxx		
10			x	x	x	x	x	xxx	x	
over 10			every year	every year	every year (2)	x	every year	every 3 year	every 3 years	40000 h

This timetable is applicable to units operating in normal conditions with an average of 4000 hours per year. If operating conditions are abnormally severe, an individual timetable must be made for that unit.

- (1) Tube testing is required if aggressive water conditions exist. Applies to condensers only on water cooled units.
- (2) Schedule as per previous analysis result or at least once a year.
- (3) Year 1 to define equipment baseline. Subsequent year based on oil analysis results or schedule as per vibration analysis.
- (4) Recommended at 40 000 run hours or 100 000 equivalent operating hours whichever comes first. Schedule also depends on results from oil analysis / vibration analysis.

Seasonal start up and shutdown are mainly recommended for Comfort Air Conditioning and annual and preventive maintenance are mainly recommended for Process application.



Additional services

Oil analysis

Trane Oil Analysis is a predictive tool used to detect minor issues before they become major problems. It also reduces failure detection time and allows planning for appropriate maintenance. Oil changes can be reduced by half resulting in lower operating costs and a lower impact on the environment.

Vibration analysis

Vibration analysis is required when oil analysis reveals the presence of wear indicating the start of possible bearing or motor failure. Trane oil analysis can identify the type of metallic particles in the oil which, when combined with the vibration analysis, will clearly point out the failing components.

Vibration analysis should be performed on a regular basis to build a vibration trend of the equipment and avoid unplanned downtime and costs.

System upgrade

This Service provides a consulting service. Upgrading your equipment will increase the unit reliability and can reduce the operating costs by optimizing the controls. A list of solutions / recommendations to the system will be explained to the customer. Actual upgrade for the system will be costed separately.

Water treatment

This Service provides all the necessary chemicals to properly treat each water system for the period designated.

The inspections will be conducted at agreed upon intervals and Trane Service First will submit a written report to the customer after each inspection.

These reports will indicate any corrosion, scaling, and algae growth in the system.

Refrigerant analysis

This Service includes a thorough analysis for contamination and solution upgrade.

It is recommended that this analysis be performed every six months.

Annual cooling tower maintenance

This Service includes the inspection and maintenance of the cooling tower at least once a year.

This involves checking the motor.

24 hours duty

This service includes emergency calls outside of the office normal working hours.

This Service is only available with a Maintenance Contract, where available.

Trane Select Agreements

Trane Select Agreements are programs tailored to your needs, your business, and your application. They offer four different levels of coverage. From preventive maintenance plans to fully comprehensive solutions, you have the option of selecting the coverage that best suits your requirements.

5 years motor-compressor warranty

This Service will provide a 5 years part and labor warranty for the motor compressor only.

This Service is only available for units covered by a 5 years Maintenance Contract.

Energy enhancement

With Trane Building Advantage you can now explore cost effective ways to optimize the energy efficiency of your existing system and generate immediate savings. Energy management solutions are not only for new systems or buildings. Trane Building Advantage offers solutions designed to unlock energy savings in your existing system.



Trane - by Trane Technologies (NYSE: TT), a global climate innovator - creates comfortable, energy efficient indoor environments for commercial and residential applications. For more information, please visit trane.com or tranetechnologies.com.

Trane has a policy of continuous product and product data improvement and reserves the right to change design and specifications without notice. We are committed to using environmentally conscious print practices.

CG-SVX062B-GB July 2023
Supersedes CG-SVX062A-GB_0223

© 2023 Trane

Confidential and proprietary Trane information