



# User Guide

For controller on scroll chillers and heat pumps  
Models  
CGB/CXB  
CGCM/CXCM



February 2020

CG-SVU008C-GB  
Original instructions



## Table of contents

Advanced electronics .....	3
Display description .....	5
Buttons description and their functions.....	7
On/Off of the unit.....	9
Set point display.....	9
Set point editing .....	9
Dynamic Set Point.....	10
Alarm display .....	11
Alarm reset.....	11
Remote control of the unit .....	12
Controlling the unit remotely by free contacts.....	12
Controlling the unit remotely by ModBus protocol .....	14
Configuration parameters.....	15
Parameters table.....	16
Alarms.....	17
Remote display .....	18



### **WARNING**

Supply the unit at least 24 hours before the initial startup to heat the compressor oil. In conditions of low water temperature, the pumps could be started in order to avoid freezing conditions. In order to avoid the breaking of heat exchangers due to water hammer, be sure to keep to water valves open. Failure to follow these instructions will void the warranty.

## **Advanced electronics**



The control logic is able to manage air-to-water and water-to-water chillers and heat pumps with a single refrigerant circuit equipped with two scroll compressors with a proportional step regulation according inlet water temperature for air-to-water or water-to-water units.



## Technical Specifications

**Power supply:** 24V AC/DC

**Digital inputs:** 5 free voltage

**Analog inputs:** 3 NTC + 1 configurable: 0÷5V, 4÷20mA, NTC

**Analog outputs Opto-Insulated:** 4 configurable: 0÷10V signal, external relay driving

**Relay outputs:** 5 x 5(2) A @ 250V SPST + 1 open collector 12Vdc 40mA max

**Remote terminal**

**Serial outputs:** 1 RS485 slave with Modbus communication protocol (only with adaptor)

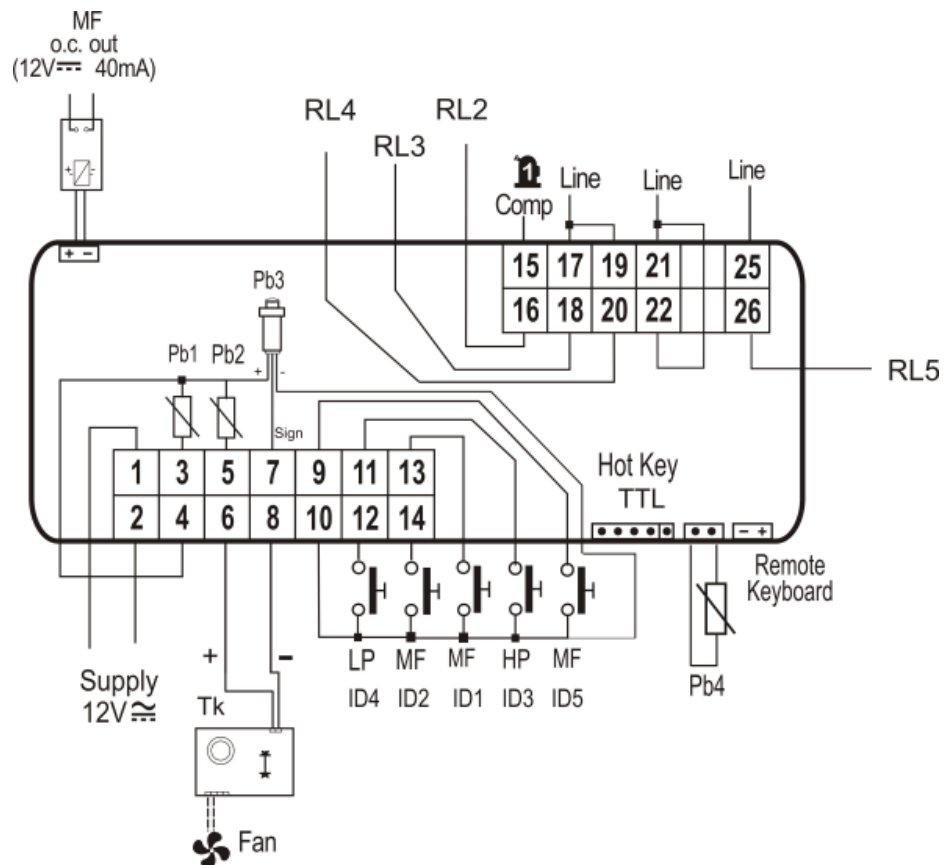



## Display description

The LED display allows you to monitor and change the status of the unit, using the 6 buttons on the keypad.



### Home screen

Press the UP and DOWN keys on the Home screen, to view the following values:

"Pb1": Displays the water temperature at the exchanger inlet air-conditioning

"Pb2": Displays the temperature of the water leaving the exchanger of air-conditioning

"Pb4": Displays the outside air temperature (only for air-to-water units if present)

"Pb3": Displays the condensing pressure in cooling mode and the evaporating pressure in heating mode

"Pb4": Displays the temperature of the water leaving the exchanger of source side (only for water-to-water units if present).









and buttons allow you to activate operation model in summer and winter.



The display shows "OnC" when the unit is on and in chiller mode.

The display shows "OnH" when the unit is on and in heat pump mode.

The display shows "OFF" when the unit is OFF.

Description of the other icons on the display:

°C -°F BAR-PSI	On when the screens display temperature or pressure
	On in programming if the screens display temperature or pressure set points/differentials
	On during programming if the lower screen displays the working hours of the loads or the time. Flashing in functions menu if the remaining time to the beginning of defrost is displayed.
	Flashing on if alarms not identified by specific icons are present
<b>Vset</b>	On if an automatic Set Point change function is active (Dynamic set point, Energy Saving)
<b>menu</b>	On during menu navigation
	On if the heaters (antifreeze/support) are on
<b>Flow!</b>	Flashing on if the digital input of the flow is active when the pump is on; with the pump off it says that the flow contact is closed
	On if at least one of the water pumps is on
	On if at least one fan is on
<b>1 2</b>	On if the relative compressor is on; flashing if the compressor is switched on with a timer
	On if the auxiliary output is active



	On if the machine is on and represents the Heat or Cool mode of operation based on the logic set in the CF31 parameter
<b>Cir1</b>	Cir1 on if in view values for circuit 1
	The icon is flashing on when counting the interval between defrosting sessions; the icon is steady on during the defrosting phase





## Buttons description and their functions

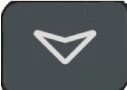
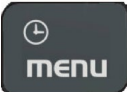

The controller is provided with six buttons to interact with user and installer parameters.

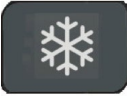
Here below the description of the accessible operations through the buttons.

	<p><b>Press and release in the main display:</b> It allows you to visualize the chiller (label SETC) or heat pump (label SetH) set point</p>
	<p><b>Press and release 2 times in the main display:</b> If the energy saving or dynamic set point is enabled for units without storage, the icon Vset is lit and the display shows the work real set</p>
	<p><b>Press for 3 seconds and release in the main display:</b> It allows you to edit the chiller / heat pump set point</p>
	<p><b>Press and release in the ALrM menu:</b> It allows you to reset the alarm (if this alarm can be reset) from the menu ALrM</p>
	<p><b>Press and release:</b> From the main display it allows you to show the values of the configured probes (temperature / pressure) in the upper display, and the corresponding label in the lower display.</p>
	<p><b>Press and release in the PrG menu:</b> It allows to slide in the parameters folders (ST, CT, etc.) and in the parameters list. In parameter editing phase, it increases the value.</p>
	<p><b>Press and release:</b> From the main display it allows you to show the values of the configured probes (temperature / pressure) in the upper display, and the corresponding label in the lower display.</p>
	<p><b>Press and release in the PrG menu:</b> It allows to slide in the parameters folders (ST, CT, etc.) and in the parameters list. In parameter editing phase, it decreases the value.</p>
	<p><b>Press and release:</b> It provides access to menu functions</p>
	<p><b>Press for 3 seconds and release:</b> It allows you to adjust the clock in the provided models.</p>

	<p><b>Press and release in the PrG menu:</b> It quits the parameter change.</p>
	<p><b>Press and release:</b> It allows you to switch on the unit on heat pump or select standby mode</p>
	<p><b>Press and release:</b> it allows you to switch on the unit on chiller or select standby mode</p>



Some controller functions are available through pressing multiple keys simultaneously. The following are the combinations accepted by the controller.

	<p><b>Press simultaneously for 3 seconds:</b> It allows to access to parameters programming</p>
	<p><b>Press simultaneously:</b></p> <ol style="list-style-type: none"> <li>1. It allows to quit parameters programming</li> <li>2. The simultaneous extended pressing of the buttons activates the manual defrost</li> </ol>





## On/Off of the unit

Pressing  or  for about 3 seconds will switch on the unit in chiller or heat pump mode. During these 3 seconds, the selected mode led flashes.

To change operating mode (i.e. to switch from chiller to heat pump mode) you must go through the standby mode first.

If the controller is on, the extended pressure on the button of the current mode (chiller or heat pump) forces the unit on standby.

In standby mode, you can still to enter in menu to change the parameters.





Alarm management is enabled also in standby mode; alarms that occur are equally shown.

## Set point display

By pressing and releasing the  button, you will see the setpoint value, **SetC** (set chiller) if the unit is in chiller mode, or **SetH** (set heat pump) if the unit is in heat pump mode.

By pressing and releasing the  button when the unit is in standby mode, it is possible to display both set points.

## Set point editing

1. Press the  key at least for 3 seconds;
2. The set point will start blinking;
3. To modify set point value, press  and  ;
4. Press the  key, or wait for the timeout to save the new value and to quit from programming;



# Dynamic Set Point

Enabling the **Dynamic Set Point** and setting the appropriate parameters to increase or decrease the set point and the range of outdoor temperatures in which this feature must be active. Refer to the Parameters table ("SD" parameters) to view the setpoints the controller will continuously change according to a proportional law.

With this function you can change the set point in order to ensure, with changing external conditions, increased comfort or higher efficiency of the unit.

Example about the increase in efficiency achieved by enabling this function:

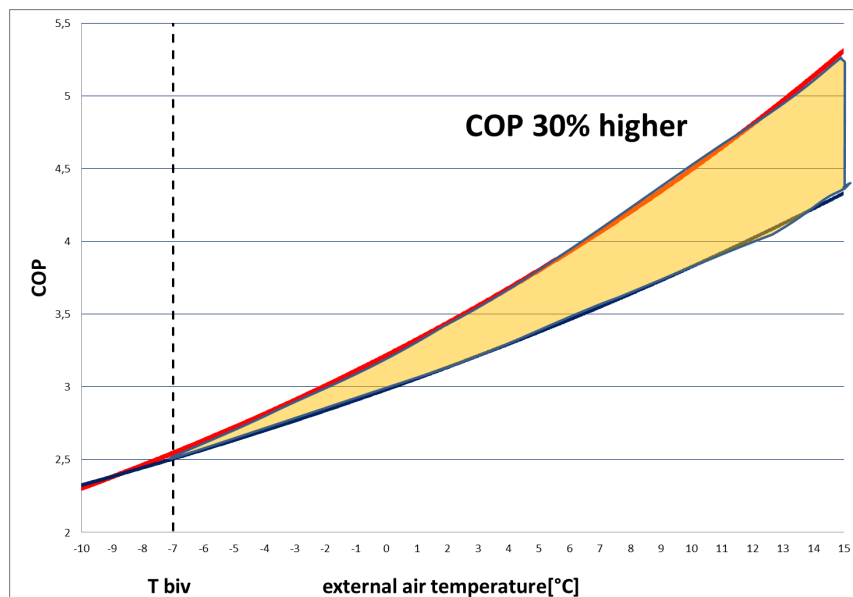
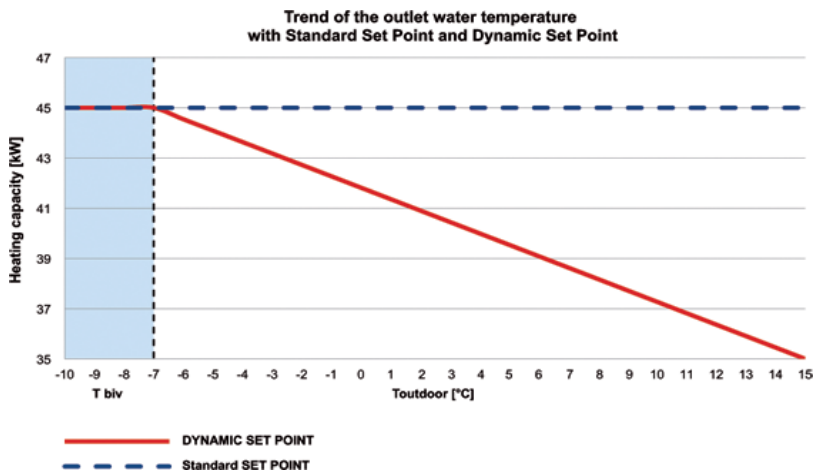





The **Dynamic Set Point** is available only for air-to-water versions equipped with external air probe.







## Alarm display

Enter to the function menu:

1. Select “ALrM” function using  or ;
2. Press and release ;
3. The pressure on  or  allows to show active alarms.

Press the Menu key or wait for the timeout, to exit this view.

## Alarm reset

1. Enter to the function menu;
2. Select the function “ALrM”;
3. Press ; lower display shows the alarm while the upper display shows the label **rSt** if the alarm is resettable, or **NO** if it isn't. Using  or  you can slide and show all active alarms;
4. Press  on the label **rSt** to reset alarm and pass to the next;
5. Press the Menu key or wait for the timeout, to exit this view.



## Remote control of the unit

It is possible to control the unit remotely with three different methods:

- Free contacts on the user terminal (X)
- ModBus protocol on RS485 slave
- Remote keypad

## Controlling the unit remotely by free contacts

On the X user terminal there are four free terminals where you can connect any type of temperature control device able to provide a current pulse to close the relay for the unit activation.

The terminals are those with the numbers 6, 20, 22B, 23 and 29, on the X user terminal. Always refer to the wiring diagram included. This contact is generally a normally open contact.

With these contacts you can enable remote On/Off, S/W change.

To enable the remote S/W changing you need modify **CF28**.

On the same terminal are also available free contacts for external reporting of general alarm.



**TRANE**

=QG		
X		
Customer Terminal Block		
NumM	NumI	Utenza
1	F	Remote ON/OFF
2	17	Remote ON/OFF
3	12	Evaporator flow switch FLE
4	13	Evaporator flow switch FLE
5	20	Alarm general relay free voltage - circuit 1 [NO]
6	21	Alarm general relay free voltage - circuit 1 [NO]
7	22	Alarm general relay free voltage - circuit 2 [COM]
8	23	Alarm general relay free voltage - circuit 2 [NO]
9	25	Alarm failure to initiate evaporator water pumps relay free voltage
10	27	Alarm failure to initiate evaporator water pumps relay free voltage
11	28	Alarm failure to initiate recovery water pumps relay free voltage
12	30	Alarm failure to initiate recovery water pumps relay free voltage
13	81	Free volt. contact for ext. water pump evaporator 1 status [NO]
14	82	Free volt. contact for ext. water pump evaporator 1 status [NO]
15	83	Free volt. contact for ext. water pump recovery 1 status [NO]
16	84	Free volt. contact for ext. water pump recovery 1 status [NO]
17	85	Free volt. contact for ext. water pump evaporator 2 status [NO]
18	86	Free volt. contact for ext. water pump evaporator 2 status [NO]
19	87	Free volt. contact for ext. water pump recovery 2 status [NO]
20	88	Free volt. contact for ext. water pump recovery 2 status [NO]
21	89	Request evaporator pump 1
22	90	Request evaporator pump 1
23	91	Request recovery pump 1
24	92	Request recovery pump 1
25	93	Request evaporator pump 2
26	94	Request evaporator pump 2
27	95	Request recovery pump 2
28	96	Request recovery pump 2
30	207	External activation set point [analog signal]
29	210	External activation set point [analog signal]

F	17	12	13	20	21	22	23	25	27	28	30	81	82	83	84	85	86	87	88	89	90	91	92	93	94	95	96	207	210	
○	○	○	○	○	○	○	○	○	○	○	○	○	○	○	○	○	○	○	○	○	○	○	○	○	○	○	○	○	○	○
○	○	○	○	○	○	○	○	○	○	○	○	○	○	○	○	○	○	○	○	○	○	○	○	○	○	○	○	○	○	○
F	17	12	13	20	21	22	23	25	27	28	30	81	82	83	84	85	86	87	88	89	90	91	92	93	94	95	96	207	210	



## Controlling the unit remotely by ModBus protocol

On the control device installed on the unit, an input is available for serial connection on RS485 port with ModBus protocol, to use this type of connection it is necessary a TTL/RS485 adaptor.

Refer to the wiring diagram below, observing a bus type connection to avoid creating star connections. You can use the master and slave RS485 port, depending on the location of the instrument in the network.

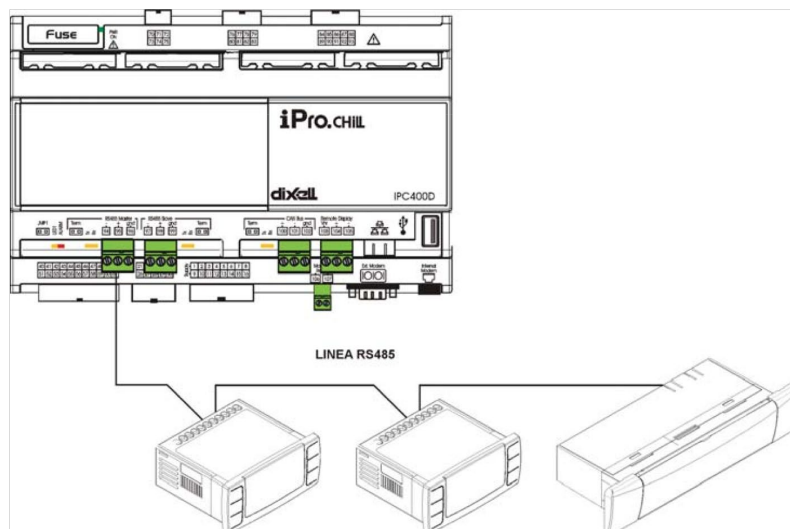

To connect to the devices to be controlled simply use two minimum cross-section of 0.5 mm<sup>2</sup> plus screen, use the input GND only for communication problems.











## Configuration parameters

Controller parameters grouped in functional folders (**CF** = configuration, **CO** = compressor...) with a specific label each. The generic group **ALL** contains all controller parameters.

There are 3 different levels: user level without password and the other two, only for authorized technician, available with password.

How to enter "Pr1":

1. Press  and  for a few seconds;
2. Icons will flash and upper display shows "ALL" (generic parameters group);
3. Slide the parameters groups using  and ;
4. Select the group that contains parameters to edit. Pressing the set button, you can enter in the parameters list of that group.  
Lower display shows parameter label and the upper its value.
5. Select parameter;
6. Press the  key to enable editing;
7. You can edit the value using  or ;
8. Press the  button to save the new value and to move to the next;
9. To exit, press the  key, when you are in parameters viewing (not during the change with blinking value), or wait for the timeout.

### NOTE:

The new value is also saved when you quit because of timeout, without pressing the  button.



## Parameters table

The parameters are grouped by macro-groups, as follows:

<b>ST</b>	Thermoregulation parameters
<b>SD</b>	Dynamic set point parameters
<b>CF</b>	Remote S/W & Automatic Change Over

Thermoregulation parameters					
Parameters	Description	min	max	u.m.	Resolution
ST1	Summer set point	ST05	ST06	°C/°F	dec/int
ST4	Winter set point	ST07	ST08	°C/°F	Dec/ int
Dynamic set point parameters					
Parameters	Description	min	max	u.m.	Resolution
Sd1	Dynamic set point 0=disabled 1=enabled	0	1	°C	
Sd2	Summer dynamic set point offset max	-30.0	30.0	°C	Dec
Sd3	Winter dynamic set point offset max	-30.0	30.0	°C	Dec
Sd4	Summer set external air temperature	-50.0	110	°C	Dec
Sd5	Winter set external air temperature	-50.0	110.0	°C	Dec
Sd6	Summer differential external air temperature	-30.0	30.0	°C	Dec
Sd7	Winter differential external air temperature	-30.0	30.0	°C	Dec
Remote S/W & Automatic Change Over					
Parameters	Description	min	max	u.m.	Resolution
CF28	S/W Change 0 = By Keypad 1 = By Digital Input 2 = By Analogic Input	0	2		
CF29	Set Automatic Change Over	-50.0	110.0	°C	Dec.
CF30	Differential Automatic Change Over	0.1	25.0	°C	Dec.
CF35	Remote keypad 0 = Not present 1 = Present	0	1		





## Alarms

The controller is able to identify all alarms that may damage the normal operation of the unit. For each alarm code, the controller performs a given action.

Below is a table with alarm codes.

Alarm code	Description
P"x"	Failure on probe "x"
A01	High pressure switch alarm
A02	Low pressure switch alarm
A05	High pressure alarm from transducer
A06	Low pressure alarm from transducer
A07	Antifreeze alarm
A08	Plant side flow alarm
A19	Source side flow alarm
A09	Compressor 1 overload
A10	Compressor 2 overload
A11	Condenser fan overload
A17	Evaporator pump overload
A18	Condenser pump overload
A12	Defrost alarm
A13	Compressor 1 maintenance request
A14	Compressor 2 maintenance request
A15	Evaporator pump maintenance request
A20	Condenser pump maintenance request
A16	High temperature evaporator water inlet
ACF"x"	Configuration alarm "x"
FErr	Working alarm condensing units
AFR	Phases sequence alarm
ALOC	Generic alarm 1



## Remote display

The remote terminal is connected directly to the controller connectors designed for the remote keypad, paying particular attention to the polarity of the connections.

Incorrect wiring may cause serious damage to the keyboard or controller.



Trane optimizes the performance of homes and buildings around the world. Trane offers a broad portfolio of advanced controls and HVAC systems, comprehensive building services, and parts. For more information, visit [www.Trane.com](http://www.Trane.com).

Trane has a policy of continuous product and product data improvement and reserves the right to change design and specifications without notice.