



Packaged Rooftop Units

Air-Conditioners and Heat Pumps

Models IH / IC – Sizes 140 to 270

120 to 270 kW

17,000 to 44,000 m³/h



Table of Contents

Introduction	3
Features & Benefits	4
Application considerations	6
Options & Accessories	8
Energy Recovery solutions.....	10
Option Compatibility Matrix	12
General data.....	13
Auxiliary heat general data.....	17
Electric data.....	18
Operating limits	18
Unit dimensions and weight	19



Introduction

With its intelligent design based on years of customer reach and field experience, Airfinity™ rooftop systems offer you excellent energy efficiency at both full load and part load, which means lower operating costs. Trane proudly designs products which are compliant with current and future EU regulations, as part of its climate commitment to reduce greenhouse gas emissions and help customers reduce their carbon footprint. Ease of maintenance and legendary Trane® toughness deliver peak performance for decades. The more you learn about Airfinity rooftop units, the more you'll see why they're the smart choice for performance, efficiency and lifetime value.

The new **Airfinity XL** is an extension on the proven Trane Airfinity™ air-to-air packaged rooftop platform. Airfinity XL rooftop units are ideal for a broad range of applications such as large warehouses, retail centers and industrial facilities, with medium to high attendance.

Most units feature an SEER higher than 4.0 and an SCOP higher than 3.5, therefore already complying with the EC directive 125/22681 that comes into force in January 2021. Moreover, Airfinity XL is certified by Eurovent, in addition to being tested in our world-class laboratories situated in north-east France.

Ecodesign Directive – EC 125/2016

In order to contribute towards Europe's sustainability and low carbon goals, the European Commission introduced since January 1st 2018 minimum seasonal efficiency requirements for rooftop units. On January 1st 2021, even stricter efficiency requirements entered into force.

Unlike for chillers and heat pumps, rooftop units must comply with both seasonal efficiency requirements in cooling *and* heating modes. Additionally, units equipped with warm air heaters, such as gas burners, should comply with maximum NOx emission levels.

The minimum efficiency requirements are provided below.

Table 1 – Ecodesign seasonal efficiency requirements

Efficiency requirement	Tier 1 2018	Tier 2 2021
Seasonal cooling space efficiency (%)	117	137
Seasonal heating space efficiency (%)	115	125
Warm air heater NOx (mg/kWh)	100	70
Warm air heater PCI (%)	72	78

Delivering Value across the total lifecycle

Trane Airfinity™ XL Rooftops have been designed having in mind the complete lifecycle of the unit. Our high efficiency units will help you to minimize your operating costs and reduce your carbon footprint. The easy plug-and-play installation and set-up will bring down your initial investment, while the smooth operation and proven reliability will help to minimize your downtime costs.

Reduced installation costs

- Plug and play packaged solution
- Lightweight design
- Customizable return and supply air configuration
- Compact packaging to minimize waste on-site

Reduced operating costs

- Tandem high efficiency scroll compressors with intermediate discharge valves
- Intelligent fresh air management with integrated Free cooling
- EC plug fan on supply side with modulating airflow for optimum consumption profile
- EC outdoor fans provided as an option
- Electronic expansion valves for tighter temperature control
- Heat recovery module for maximum energy savings
- Air-tight panel construction with double wall reinforced insulation to minimize air leakages

Reduced maintenance costs

- Double refrigeration circuit for enhanced reliability
- EC Plug fan requiring zero maintenance
- Dynamic defrost cycles and anti-freeze protection
- Reliable operation with the CH536 Trane controller
- Easy access to filtration and key components through hinged door panels
- Remote unit management with alarm notifications

Features & Benefits

Airfinity™ is a packaged plug and play solution, and an ideal all-in-one solution for retail applications. These units can be installed on the roof or on the ground. Airfinity units are equipped with many standard features that bring energy savings and improve comfort through tight temperature regulation and high indoor air quality.

Unit construction

The indoor section is provided with double skin panels as standard, with 50 mm thick glass wool insulation. The unit casing is constructed of zinc coated, heavy-gauge, galvanized steel, painted with a polyester white RAL 9002 powder paint. The door panels are constructed The All seams have been tightly sealed to prevent water leakages due to rain and snow. The modular cabinet construction allows easy access for maintenance on both sides of the unit.

Airflow configuration

Airfinity XL units are designed to be connected to new or existing customer ductwork. They can be provided in vertical flow or horizontal flow, or a combination of both. Duct connections are by default of the rectangular type. For different supply/return configurations, or different connection types (e.g. circular ducts), contact your local Trane sales representative.

Figure 1 – Down flow (left) and horizontal flow (right) configurations (shown in heating mode)



Tandem refrigeration circuits with advanced IDV scroll compressor technology

Rooftops are popular because of their “packaged” nature. They are a unique type of HVAC equipment which can provide cooling, heating and ventilation contained in a single package. With this convenience comes some challenges, such as correctly matching cooling capacity to building load. Matching the rooftop’s capacity to the building load is critical, which is why the Airfinity XL line offers always dual refrigeration circuits with high efficiency scroll compressors in tandem. Thanks to the intelligent capacity staging managed by the Trane CH536 controller, Airfinity XL units can easily adapt to the building load – and they do so efficiently by taking advantage of the innovative Intermediate Discharge Valve technology on scroll compressors.

Quality and Reliability

All Airfinity designs have been rigorously rain-tested at the factory to ensure water integrity. Every unit and its options receive a unit run test before leaving the production line to make sure it lives up to customer requirements. Airflow tests are also conducted, to ensure there are no leakages.

The refrigerant circuit design has been optimized to minimize pipe length and improve serviceability. The heat exchanger is manufactured using aluminized steel with stainless steel components for maximum durability. We perform a 100% coil leak test at the factory. The evaporator and condenser coils are leak tested at 1.4 MPa and pressure tested to 3.1 MPa.

Indoor Air Quality

The ventilation section is fully insulated with a double wall panel and glasswool insulation with 50 mm thickness and density according to norm DIN EN 1602. The insulation is completely sealed, requiring no maintenance. Panels in the indoor section are fire-resistant.

Each unit is equipped with two filter rails upstream of the indoor coil, G4 (65% Coarse) pre-filters with M1 fire classification are standard. To upgrade filtration, there are the following filter grade combinations:

G4+F7 (65% Coarse + ePM1 55%)

F5+F7 (85% Coarse + ePM1 55%)

G4+F9 (65% Coarse + ePM1 80%)

All filters are certified by Eurovent and comply with EN norms.

Airfinity rooftops are fitted with EC plugs fans as standard to ensure that no rubber dust particles (typically associated to belt fans) will be carried into the air stream.

Intelligent control with Trane CH536

The Trane CH536 controller software has been completely designed by Trane engineers, leveraging many years of expertise in comfort cooling and heating applications. It provides unit control for heating, cooling and ventilation, utilizing input from sensors that measure outdoor and indoor temperature and humidity.

The CH536 controller improves quality and reliability through the use of time-tested controls and logic:



- Prevents the unit from short cycling, considerably improving compressor life.
- Ensures that the compressor will run for a specific amount of time which allows oil to return for better lubrication, enhancing the reliability of the compressor.
- Reduces the number of components required to operate the unit, thereby reducing possibilities for component failure.
- Features expanded diagnostic capabilities when utilized with Trane's Tracer™ Systems.
- Softens electrical "spikes" by staging on fans, compressors and heaters.
- Includes internal log memory to record unit operating trends (e.g. temperatures before alarm occurrence).

The Intelligent Fallback or Adaptive Control is a benefit to the building occupant. If a component goes astray, the unit will continue to operate at predetermined temperature set points.

Figure 2 – Trane CH536 controller



Electronic Expansion Valves

Airfinity™ units are equipped with electronic expansion valves (EEV) as standard on all models. Working together with the CH536 controller, the EEV allow to optimize the performances in both cooling and heating mode while providing reliable and accurate operation in all conditions, no matter what time of the year. Furthermore, unlike conventional expansion valves, EEV ensures smooth and precise control at low capacities, improving part load performances.

Improved serviceability

Cabinet construction

When designing the new Airfinity™ XL, engineers paid close attention to specific design features to facilitate unit maintenance. The unit panel doors are fully built in light-weight aluminum to make them easier to handle and recycle. Flexible hinged access allows the door to be opened from the left or the right, depending on the accessibility on site. Hinges are non-intrusive, to improve unit tightness and prevent air leakages.

Condensate drain pan

The condensate drain pan, which collects the condensate under the indoor coil, is fully built in aluminum to avoid corrosion. The slightly inclined design promotes better evacuation of the condensate, avoiding still waters which lead to bacteria formation. The drain pan is fully removable, so it can be easily cleaned.

Replacement filters

Do you already have other Airfinity™ units installed on site? The XL units use exactly the same filter references and dimensions, making it easier for customers to purchase replacement parts and keep them in stock.

Figure 3 – Schematic of condensate drain pan and filter shown partially retracted

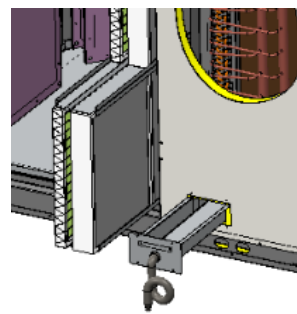

Component access

All key components, such as fans and compressors, are easily accessible to quick maintenance. The control panel is conveniently located on the outdoor section, to avoid any obstructive access with the unit is connected to ductwork.

Figure 4 – Control panel location (unit shown open)

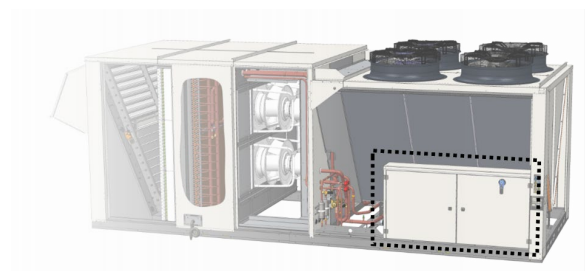

Application considerations

Modulating airflow

In a typical retail application, your rooftop unit will run in part load more than 95% of the time. That's why Trane selected the EC plug supply fan, provided as a standard on all Airfinity units. Thanks to the embedded variable speed motor, the rooftop is quieter, more efficient and more reliable compared to other technologies.

The Trane CH536 controller is programmed with the capability to automatically regulate the supply fan speed according to the building load. In other words, when the building load is lower than the cooling capacity delivered, the controller will start to disable compressors until the requirement is met. Once a compressor stage is disabled, the EC plug fan will proportionally reduce its speed (RPM) in order to prevent a cold (or not) shower effect.

Due to the performance characteristics of EC fans, reducing the fan speed RPM has the added advantage of significantly lowering the fan power consumption, which in turn increases the overall coefficient of performance of the rooftop unit.

The combination of compressor staging and fan RPM adjustment allows the rooftop unit to deliver even higher efficiency at part load, making Airfinity units ideal for applications where the building load varies widely throughout the year, as is the case for most retail and commercial applications.

Figure 5 – Typical performance curve for a rooftop unit in relation to supply airflow

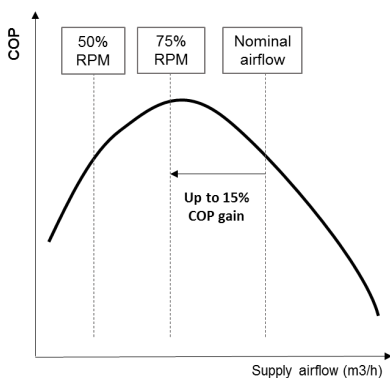

Furthermore, the EC plug fan selected for Airfinity™ units has many technical advantages which allow you to maximize the comfort in your building and improve the indoor air quality, such as:

- Prevent cold shower effects
- Prevent air stratification when using auxiliary heating
- Avoid rubber dust typically due to belt wearing
- Limited vibrations thanks to anti-vibrations mounts (reduced noise)
- Reduced starting amps
- Suitable for textile ducts

Predictive Intelligent Management of Alternate Defrost cycles (PrIMA)

The capability of a reversible rooftop unit to manage the defrosting cycle is vital for the overall reliability and efficiency of the operation. A defrost cycle occurs when the rooftop is running in heating mode while the outdoor heat exchanger comes in contact with cold air. This could lead to the formation of a thin layer of ice which substantially reduces the efficiency of the unit.

Traditionally, rooftop unit controllers would signal an alarm when the evaporator reached a certain temperature, and immediately reverse the refrigeration cycle so that the rooftop operates in cooling mode during a certain period of time (in order to increase the evaporator surface temperature, and therefore melt the ice). During this period, if supply fans are not turned off, the unit will effectively blow cold air into the building, compromising comfort for building users and creating what is known as a cold shower effect. It also drastically reduces the efficiency of the HVAC system, since the unit will have to recover the temperature set point faster once the defrost cycle is reverted.

In order to minimize penalizing the efficiency of the unit, or compromising the comfort of building occupants, Trane has developed a predictive algorithm (PrIMA) that uses a dynamic temperature and pressure set point to anticipate defrost cycles before the freezing point is practically achieved, thus delaying the start of the defrost mode, and ultimately reducing the duration of the defrost cycle.

Moreover, the PrIMA algorithm intelligently uses the dual refrigeration circuit capability to perform alternate defrosting, this way ensuring that the unit will at least be partially delivering heating capacity while the short defrost cycle is taking place.

PrIMA also drastically reduces the number of defrost cycles over the lifecycle of the unit, reducing the strain on key components like compressors and four-way valves, which occur every time there is a reversal in the operating mode of the unit.

During development stages, Trane engineers conducted internal laboratory tests to properly measure the behavior of an Airfinity™ rooftop unit during defrost cycles. It was found that, compared to the legacy product tested in the same lab, Airfinity™ units had a 50% shorter average period between defrost cycles.

Multiple heat source management

For mild climates, the rooftop heat pump is the preferred source of heating since it has a high COP, which in turn reduces operating costs compared to other traditional heating systems. In some regions, the heat pump is unable to fulfill the building demand throughout the winter, particularly in colder climates like Northern and Eastern Europe.

In these cases, it is possible to install an auxiliary heater in the rooftop unit to provide supplemental heating. Auxiliary heating options provided are: electric heater, hot water coil, or modulating gas burner. The preferred choice will depend on the heat capacity required, and the winter design conditions, as well as the availability of gas on-site.

When a heat pump rooftop unit is equipped with an auxiliary heater, heating priority is given by default to the most energy efficient mode (thermodynamic). Only when the heat pump is unable to fully meet the demand will the auxiliary heater be turned on. This is also known as the bivalent temperature (Figure 6). The two heating modes (auxiliary heat + thermodynamic) will continue to work simultaneously until the heat pump circuit turns off due to too low ambient temperature. In this case, the auxiliary heater will work as a stand-alone.

Thanks to the Trane CH536 controller, the building owner can customize the priority between different heating mode based on local atmospheric conditions and building needs.

In some cases, designers may choose to have an independent source of heating, or to only use gas or electric heat as a source of heat, instead of a heat pump. In this case, the rooftop unit will function as an air-conditioner when cooling is required, and in heating mode only the ventilation fans and auxiliary heater will operate.

Figure 6 – Building heating management

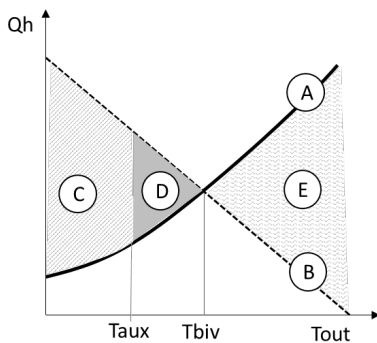

Legend:

- Qh – Heating capacity (kW)
- Tout – Outdoor ambient temperature (°C)
- Tbiv – Bivalent temperature (°C)
- Taux – Minimum temperature for heat pump (°C)
- A – Heat pump capacity
- B – Building heat load
- C – Auxiliary heating
- D – Auxiliary heating + heat pump
- E – Heat pump stand-alone

Fresh air management & Free Cooling

Every Airfinity™ unit is provided with an economizer as standard. The economizer increases energy savings by enabling free cooling mode every time outdoor conditions are favorable. This way, seasonal efficiency can be maximized by reducing the need for thermodynamic cooling or heating during mid-season.

The economizer consists of:

- A motorized damper with separate fresh air and return air sections;
- Mixed air chamber
- A fresh air hood with a protection grille
- Temperature sensors for free cooling operation (humidity sensors provided with enthalpy free cooling option)

Fresh air percentage can vary from 0 to 100% of nominal airflow. The mechanical opening of the damper is managed by the actuator which is controlled via the Trane CH536 controller. When the unit is in free cooling mode, the damper will be automatically fully opened.

Figure 7 – Economizer section in the Airfinity XL unit, shown open

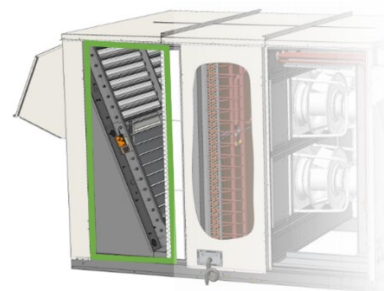

Building pressurization control

The external static pressure (ESP) of a rooftop unit is defined as the static pressure between inlet and outlet of the unit, including all options and accessories and excluding ductwork. This external static pressure will be used to push the air through the supply and the return ductwork installed on site. It can be computed summing the supply duct pressure drop with the return pressure drop.

It is recommended, for a basic unit, that the return ductwork pressure drop be lower than 150 Pa in order to accommodate operating modes which demand high fresh air rates, such as free cooling.

In the case that the return ductwork pressure drop is higher than 150 Pa, several exhaust options exist in order to control building pressurization.

Table 2 - Extraction options Comparison

Table 2 - Extraction options comparison

	Gravity damper	Exhaust fans	Return roofcurb
Building air tightness	Medium	Medium	High
Pressure drop in the return ductwork	Below 50 Pa	Up to 200 Pa	Up to 250 Pa
Building pressure control	Low	Low	Medium
Fresh air rate	Low to medium	High	High
Volume of exhaust air	Low	Medium	Medium
Typical applications	Warehouses, large retail spaces	Small retail, gas stations	Cinemas, new air-tight buildings

Options & Accessories

The Airfinity XL product line comes with a wide range of options and accessories to ensure all the flexibility and versatility you need.

Auxiliary heating options

Modulating hot water coil

The hot water coil can be fitted when additional heat is required and hot water is available from an external device (e.g. boiler). An additional factory-mounted coil is located after the indoor coil and offers fully modulating heating control by the use of a 3-way valve. The control is managed by measuring the delta between the mixed air temperature and zone temperature.

To ensure proper operation, the pump circulating hot water should be permanently working to avoid water freezing in the coil. Otherwise, it is recommended to use ethylene glycol. Refer to Installation and Operation for more details.

Figure 8 – Auxiliary heater fitted inside the unit (shown in downflow configuration). Left image : Hot water coil. Right image : Electric heater.

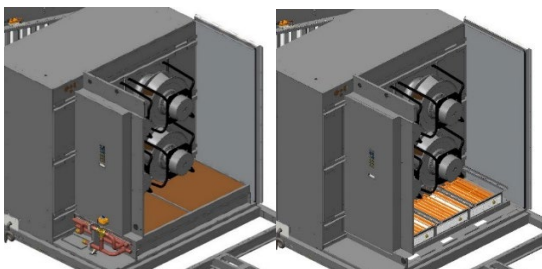

Staged Electric heaters

The units can be equipped with one or two electric heaters, depending on the model. These heaters are mounted under the supply fan discharge. Each electric heater provides two heating stages, for better comfort and reduced energy consumption. Sizes available, as well as the heating capacity by stage, are given in Table 3. The heaters are equipped with safety overheat thermostats for safe operation.

Table 3 – Electric heater characteristics

Unit size	Heating capacity stages (kW)	Maximum power input (kW)
140	37.5 + 37.5	75
150	37.5 + 37.5 + 12.5	75
170 / 190	37.5 + 25 + 37.5 + 12.5	100
220	37.5 + 37.5 + 37.5 + 37.5	112.5

Modulating gas burner

Both IH and IC models can be equipped with a gas burner, to be connected to the customer gas supply network. The gas burners are suitable for use with natural gas or propane. Thanks to its 20 – 100% modulation capacity range, Airfinity gas burners can easily adapt the unit heating capacity to the building load. Efficiency of the burner reaches 94% at full load and 105% at part load.

The gas burner is mounted inside the unit, and increases the total unit length by approximately 1 meter, without affecting the width or height. In addition to the ventilating fan, combustion chamber, burners, and single electrode to detect the flame, the gas burner module is also supplied with a chimney to ensure proper evacuation of flue gases according to local building codes.

Table 4 – Gas burner models available

Option	Model	Maximum heat output	Minimum Load
Low	PCH132	126 kW	14 kW
Standard	PCH162	160 kW	18 kW
High	PCH212	194 kW	22 kW

Humidity control

When the room temperature reaches the desired set point but the humidity level is above the requirement, the Trane CH536 controller will automatically signal the unit to begin dehumidification of the supply air using an auxiliary heater fitted into the unit.

This option is particularly interesting for retail spaces which used closed refrigeration cabinets, in order to prevent condensation on the windows.



Control options

Wall-mounted room user interface (Touch THP05)

The THS04 is a remote wall-mounted user interface intended for the end-user. It includes an incorporated temperature sensor which is used to measure the temperature inside the room.

The intuitive and user-friendly touchscreen display provides information such as operating mode, ventilation status, temperature set points, percentage of fresh air and outdoor temperature. A user can set the desired temperature, remotely adjust the operating mode of the unit, and set a daily, weekly or monthly schedule.



An admin user can access advanced settings of the THP05 via a password. The privileged access allows to adjust more parameters and view alarms.

For more information, refer to the User Guide.

Service interface (PGD)

The PGD service interface can easily be plugged to unit controller using an Ethernet cable. It can be wall-mounted for remote access or stored in the unit control panel. The PGD is highly recommended in case commissioning and maintenance of the unit is to be done by the customer or a local contractor.

The interface is composed of six different buttons and a graphical display. This view of plug-and-play service and the controller allows building owners and maintenance personnel to read and modify all unit parameters such as unit settings, operating time and number of compressor starts, low and high pressure reading, and airflow rate of supply fan. The PGD also allows to read the history of the last 32 alarms.

The service terminal is available in multiple European languages.

Figure 9 – PGD Service Terminal



Tracer™ Concierge

Trane's Tracer™ Concierge system is a cost-effective and modernized system manager which provides building managers a convenient way to manage up to 30 rooftops units in a single location. The system has been designed after years of extensive customer research, and aims to be a practical tool for retail building managers who want simplicity and cost savings.

Main features of Tracer™ Concierge include:

- Manage the building comfort system as thermal zones (e.g. when more than one unit is associated to a zone);
- Build a daily/weekly/monthly/yearly schedule, incorporating economy running periods to reduce energy consumption ;
- Manage, within adjustable limits, unit/zone temperature setpoints;
- Manage up to 4 auxiliary devices, such as lighting system, exhaust fans
- Access and clear unit alarms

The system works on ModBus communication and requires nothing more than standard return air temperatures mounted in the unit, making it highly affordable and easy to install. More customized solutions can be provided depending on customer requirements.

The Tracer™ Concierge app has a sleek and modern design, making it very intuitive and easy to use for both building users and technicians. The app can be installed on any iOS or Android device, including tablets and smartphones. As long as the system is connected to the building VPN network, the Concierge system can be accessed remotely, anywhere, everywhere.

A dedicated Concierge tablet can be provided as optional. This tablet has been designed for high durability and industrial use, and can easily be mounted on a wall and connected to the master-unit via an ethernet cable up to 100 meters.

Figure 10 – Tracer Concierge™ user interface (tablet)



Figure 11 – Tracer Concierge™ user interface (smartphone)



Building pressurization control

Barometric relief damper

Typically, the maximum overpressure recommended inside a building is 12 to 25 Pa. Excessive overpressure can lead to unwanted effects, such as tight doors, air whistling through windows and doors, etc.

The barometric relief damper uses gravity to relief pressure whenever fresh air is introduced into the building. It is recommended when the application demands fixed fresh air rates up to 25%.

If the return air pressure drop is above the building overpressure requested by the customer (e.g. 25 Pa), the barometric relief dampers will open.

The barometric relief damper is installed under the fresh air section and provided as standard with the economizer for downflow configuration. One or two dampers are provided, dependent on the size of the unit.

Figure 12 – Barometric relief damper in downflow (left) and horizontal flow (right) configurations



Exhaust fans

Variable speed exhaust EC fans work together with the barometric relief dampers and supply fans to exhaust air from the building to the outdoors when high fresh rates are being used. This option is recommended when there is a maximum of 200 Pa pressure drop in the return duct.

The exhaust fans are fitted in the fresh air section, before the economizer. They are only activated when the fresh air rate exceeds a preset value, and the overpressure can no longer be compensated by the barometric relief damper. Up to 50% of the nominal airflow can be exhausted, depending on the pressure drop in the return ductwork.

Figure 13 – EC exhaust fans in downflow (left) and horizontal flow (right) configurations

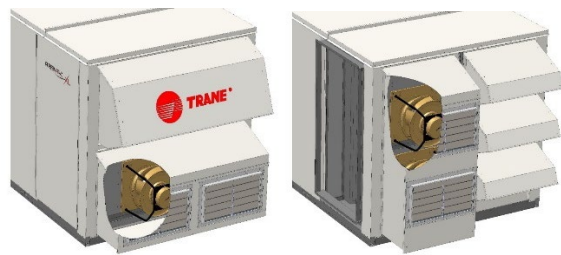

Return roofcurb

The return roofcurb is recommended when there is a significant pressure drop in the return duct (up to 250 Pa). This options allows a tighter control of the return airflow and balances it with the supply airflow, especially when the supply fan is not enough to overcome both supply and return static pressure (ESP).

The return roofcurb is installed below the unit and has EC plug fans integrated into the module. The number of fans depends on the unit size. The module is fully powered by the rooftop itself. The roofcurb is also equipped with an additional damper for exhaust air.

This roofcurb can be used in either horizontal flow, or down flow, or multi-directional flow.

Energy Recovery solutions

To enhance energy savings and reduce operating costs, Airfinity rooftops can be equipped with a packaged and easy-to-install heat recovery system. All heat recovery systems for rooftops provided by Trane are designed to maximize efficiency with little to no impact on footprint and installation time.

Energy Recovery Module (ERM)

The Energy Recovery Module is a packaged system that transfers heat (cool or warm) from exhaust air to outdoor air.



It is an add-on module that includes a enthalpy rotary wheel, EC exhaust fan, G4 filter (on exhaust and outdoor air sections) and gravity dampers. The module is fully powered by the rooftop itself and managed via the Trane CH536 unit controller.

Thanks to the enthalpy rotary wheel, both sensible and latent heat is transferred from the exhaust air stream to the outdoor air stream, which makes this system more energy efficient compared to conventional plate heat exchangers. The module has been fully designed by Trane and optimized to minimize the overall pressure drop in the system. The rotary wheel is certified by Eurovent.

Figure 14 – Trane Airfinity XL unit fitted with an Energy Recovery Module

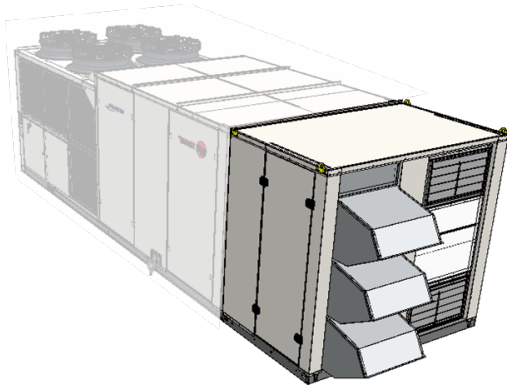

Airfinity rooftops fitted with the ERM can still benefit from free cooling mode, and high fresh air rates up to 100%. The high airflow option allows to exhaust up to 100% nominal airflow as well, in order to manage building pressurization in free cooling conditions.

Every ERM is equipped with the necessary sensors and a micro-inverter to reduce the rotation speed of the wheel when the outdoor temperatures is below -2°C, in order to protect the module against freezing.

For more information regarding the installation and operation of the ERM, please consult the Installation & Operation Manual.



Option Compatibility Matrix

Legend: (S) Standard feature

(O) Factory-fitted option

(A) Field-mounted accessory

	Name	Application / benefit	Type	IH	IC
VENTILATION & IAQ	G4 filters	Filter the air – 50mm	S	✓	✓
	G4+F7 filters	Filter the air – 50mm + 50mm	O	✓	✓
	G4+F9 filters	Filter the air – 50mm + 50mm	O	✓	✓
	F5+F7 filters	Filter the air – 50mm + 50mm	O	✓	✓
	Clogged filter detector	To facilitate maintenance of the filters by sending an alarm whenever the pressure drop of the filter reaches or exceeds a user-defined value	O	✓	✓
	EC plug fan	Modulating airflow on supply fan to deliver optimum comfort with higher energy savings. Includes progressive start-up for textile duct applications	S	✓	✓
	Dehumidification	Suitable for retail spaces which use closed refrigeration cabinets. Unit is fitted with electric heater which manages dehumidification of the air	O	✓	✓
FRESH AIR MANAGEMENT	Fresh air damper and hood	A motorized fresh air damper introduces a permanent amount of fresh air into the unit, up to 100% of the nominal airflow. The damper position is adjusted by an actuator managed by the Trane controller.	S	✓	✓
	Economizer with temperature control	The economizer comprises the fresh air hood, damper and sensors to enable free cooling when outdoor conditions are favorable. Dry bulb control (temperature-based) provided as standard.	S	✓	✓
	Economizer with enthalpy control	Economizer is equipped with an additional humidity sensor in order to measure indoor and outdoor enthalpy (energy content), for more accurate control and higher energy savings	O	✓	✓
	Energy Recovery Module (ERM)	Allows to recovery heat from the exhaust air and transfer it to the fresh air, thus reducing the need for mechanical work. Includes exhaust fan and gravity damper.	A	✓	✓
	CO2 sensor	Sensor installed in the room or ductwork measures the concentration of carbon dioxide (e.g. level of occupancy) in order to increase or decrease the fresh air amount in the buildings	O	✓	✓
PRESSURIZATION	Barometric relief damper	Reliefs pressure when fresh air is being introduced into the building. Adequate for buildings with good air tightness. Available as standard on downflow units only.	S	✓	✓
	Exhaust fans	Minimizes overpressure in the building caused by introduction of fresh air, used in combination with barometric relief damper (included). Pressure drop in the return ductwork up to 200 Pa	O	✓	✓
	Return roof curb	For applications with high fresh air rates and where system balancing is critical. Roof curb with additional damper and EC plug fan extracts up to 300 Pa at nominal airflow rate.	A	✓	✓
SAFETY	Smoke detector	Trips off in case of presence of smoke in the supply side of the unit. Automatically closes the return air and stops the unit.	A	✓	✓
	Fire thermostat	Stops the unit when temperature of the air stream rises abnormally	A	✓	✓
	Epoxy fin coating	Provides additional coil corrosion resistance to protect indoor aluminum fins	O	✓	✓
	Network protection relay	Detects phase loss, reversal and imbalance from main power supply/ In case of fault, unit stops. Phase reversal protection provided as standard	O	✓	✓
	Compressor soft starter	Limits the starting current of the compressor for a smooth re-start (e.g. after a power failure)	O	✓	✓
AUX.	Hot water coil	Provides auxiliary heating using hot water (requires hot water external device such as heat pump or boiler, etc.)	O	✓	✓
	Electric heater	Provides auxiliary heating using electric heater fitted to the unit	O	✓	✓
	Gas burner	Provides auxiliary heating using staged or modulating gas burner module fitted to the unit	O	✓	✓
CONTROLS	Airflow measurement	Allows to measure airflow based on air differential pressure sensor. PGD Display included.	O	✓	✓
	Remote service terminal (PGD)	Service terminal intended for use by building owners and maintenance personnel. Allows to access and adjust advanced unit parameters.	A	✓	✓
	Touch THP05 Room User interface	Simple user interface to access and adjust basic unit parameters. Includes room temperature thermostat. Intended for end-users.	A	✓	✓
	Tracer™ Concierge	Manage up to 30 rooftop units with a modern and affordable system controller, including remote access and compatibility with smartphones		✓	✓
	ModBus interface	To communicate on a ModBus network at the unit level.	S	✓	✓
	BacNet interface	To communicate on a BACnet® MS/TP network at the unit level. Suitable for integration with Building Management Systems.	O	✓	✓
	LonTalk interface	To communicate on a BACnet® MS/TP network at the unit level. Suitable for integration with Building Management Systems.	O	✓	✓
	Customer I/O option module	Module required for user-defined external input/output signals (i.e. conventional thermostat). PGD service terminal recommended.	O	✓	✓
ENERGY RECOVERY	Energy recovery module (ERM)	Recover energy contained in the exhaust air using an enthalpy rotary wheel. Mixed air streams increase efficiency of the machine.	O	✓	✓
	Energy recovery circuit (ERC)	Recover energy contained in the exhaust air using an additional refrigeration circuit contained in the main unit.	O	x	x
	Low ambient	Recommended when units are expected to work below +10°C outdoor air in cooling mode. EC axial fans are fitted to the condensing section to reduce the airflow when required.	O	✓	✓

Reversible heat pump units (IH models) – R454B

Size		140	150	170	190	220	250*	270*
Indoor fan								
Nominal airflow	(m ³ /h)	24000	26000	28000	33000	36000	42000	44000
Minimum airflow	(m ³ /h)	19200	20800	22400	26400	28800	33600	36800
Maximum airflow	(m ³ /h)	28800	31200	33600	39600	42000	44000	44000
Type		EC plug fan						
Number of fans		3	3	3	4	4	4	4
Maximum power input (standard)	(kW)	3.5	3.5	5.7	3.5	5.7	5.7	5.7
Available static pressure at nominal flow rate	(Pa)	400	400	400	400	400	400	400
with oversized drive	(Pa)	800	800	800	800	800	800	800
Outdoor fan								
Type		Axial						
Number		4	4	4	4	4	6	6
Total airflow	(m ³ /h)	53560	53560	53560	66816	66816	95484	95484
Performance data (cooling mode)								
Net cooling capacity (1)	(kW)	137.6	150.6	161.5	184.9	200.0	222.9	239.3
Total power input	(kW)	42.2	48.7	55.5	67.1	79.2	89.0	96.7
Net EER	(kW/kW)	3.26	3.09	2.91	2.76	2.52	2.50	2.47
Seasonal space efficiency in cooling	(%)	187.9	182.6	170.3	160.5	145.4	142.3	138.1
SEER	(kW/kW)	4.77	4.64	4.33	4.09	3.71	3.63	3.53
SEER class		A	B	B	B	B	-	-
Performance data (heating mode)								
Net heating capacity (1)	(kW)	135.9	152.0	166.8	194.7	217.8	248.7	267.5
Total power input	(kW)	38.1	43.1	47.5	59.0	68.4	85.6	94.0
Net COP	(kW/kW)	3.57	3.52	3.51	3.30	3.18	2.91	2.84
Seasonal space efficiency in heating	(%)	135.1	137.0	140.1	133.8	126.6	127.2	125.1
SCOP	(kW/kW)	3.45	3.50	3.58	3.42	3.24	3.26	3.20
SCOP Class		B	B	B	B	B	-	-
General data								
Compressor type		Variable volume scroll						
Number of circuits / compressors		2 / 2	2 / 2	2 / 2	2 / 2	2 / 2	2 / 2	2 / 2
Refrigerant charge per circuit (5)	(kg)	16	16	16	17	17	20	20
Oil quantity per circuit (5)	(kg)	6.6	6.6	7.2	9.7	12.2	12.2	12.2

(1) According to EN-14511:2018 - indoor: 27°C/19°C, outdoor: 35°C (cooling), Indoor: 20°C, outdoor 7°C/6°C DB/WB (heating)

(2) At Eurovent conditions, with 1pW reference sound power, according to ISO9614

(3) With low ambient temperature option

(4) Without auxiliary heat

(5) Refrigerant and oil charge values are not binding, please check the effective quantity of refrigerant shown on unit nameplate.

* Out of scope of Eurovent certification program

Reversible heat pump units (IH models) – R410A

Size		140	150	170	190	220*	250*	270*
Indoor fan								
Nominal airflow	(m ³ /h)	24000	26000	28000	33000	36000	42000	44000
Minimum airflow	(m ³ /h)	19200	20800	22400	26400	28800	33600	36800
Maximum airflow	(m ³ /h)	28800	31200	33600	39600	42000	44000	44000
Type		EC plug fan						
Number of fans		3	3	3	4	4	4	4
Maximum power input (standard)	(kW)	3.5	3.5	5.7	3.5	5.7	5.7	5.7
Available static pressure at nominal flow rate	(Pa)	400	400	400	400	400	400	400
with oversized drive	(Pa)	800	800	800	800	800	800	800
Outdoor fan								
Type		Axial						
Number		4	4	4	4	4	6	6
Total airflow	(m ³ /h)	53560	53560	53560	66816	66816	95484	95484
Performance data (cooling mode)								
Net cooling capacity (1)	(kW)	139.8	153.6	162.7	187.2	201.8	221.0	236.8
Total power input	(kW)	42.7	50.2	57.5	69.6	82.0	90.9	98.3
Net EER	(kW/kW)	3.27	3.06	2.83	2.69	2.46	2.43	2.41
Seasonal space efficiency in cooling	(%)	183.0	182.6	171.0	162.6	145.0	142.0	138.6
SEER	(kW/kW)	4.65	4.64	4.35	4.14	3.70	3.63	3.54
SEER class		B	B	B	B	-	-	-
Performance data (heating mode)								
Net heating capacity (1)	(kW)	136.6	152.9	170.0	195.7	218.4	254.1	272.6
Total power input	(kW)	38.4	44.6	49.9	61.0	71.6	92.0	100.5
Net COP	(kW/kW)	3.56	3.43	3.41	3.21	3.05	2.76	2.71
Seasonal space efficiency in heating	(%)	131.8	131.8	135.8	129.8	126.2	127.1	125.6
SCOP	(kW/kW)	3.37	3.37	3.47	3.32	3.18	3.22	2.98
SCOP Class		B	B	B	B	-	-	-
General data								
Compressor type		Variable volume scroll						
Number of circuits / compressors		2 / 2	2 / 2	2 / 2	2 / 2	2 / 2	2 / 2	2 / 2
Refrigerant charge per circuit (5)	(kg)	20.0	20.0	20.0	21.5	21.5	25	25
Oil quantity per circuit (5)	(kg)	6.6	6.6	7.2	10.3	13.4	13.4	13.4

(1) According to EN-14511:2018 - indoor: 27°C/19°C, outdoor: 35°C (cooling), Indoor: 20°C, outdoor 7°C/6°C DB/WB (heating)

(2) At Eurovent conditions, with 1pW reference sound power, according to ISO9614

(3) With low ambient temperature option

(4) Without auxiliary heat

(5) Refrigerant and oil charge values are not binding, please check the effective quantity of refrigerant shown on unit nameplate.

* Out of scope of Eurovent certification programme

Cooling only units (IC models) – R454B

Size		140	150	170	190	220*	250*	270*
Indoor fan								
Nominal airflow	(m ³ /h)	24000	26000	28000	33000	36000	42000	44000
Minimum airflow	(m ³ /h)	19200	20800	22400	26400	28800	33600	36800
Maximum airflow	(m ³ /h)	28800	31200	33600	39600	42000	44000	44000
Type		EC plug fan						
Number of fans		3	3	3	4	4	4	4
Maximum power input (standard)	(kW)	3.5	3.5	5.7	3.5	5.7	5.7	5.7
Available static pressure at nominal flow rate	(Pa)	400	400	400	400	400	400	400
with oversized drive	(Pa)	800	800	800	800	800	800	800
Outdoor fan								
Type		Axial						
Number		4	4	4	4	4	6	6
Total airflow	(m ³ /h)	53560	53560	53560	66816	66816	95484	95484
Performance data (cooling mode)								
Net cooling capacity (1)	(kW)	140.0	153.9	170.5	194.1	211.6	233.3	247.2
Total power input	(kW)	41.0	47.4	53.9	65.4	76.2	82.6	89.4
Net EER	(kW/kW)	3.41	3.25	3.16	2.97	2.78	2.82	2.77
Seasonal space eff. in cooling	(%)	196.4	188.0	179.8	165.7	149.1	147.3	142.1
SEER	(kW/kW)	4.99	4.78	4.57	4.22	3.80	3.76	3.63
SEER Class		A	A	B	B	-	-	-
General data								
Compressor type		Variable volume scroll						
Number of circuits / compressors		2 / 2	2 / 2	2 / 2	2 / 2	2 / 2	2 / 2	2 / 2
Refrigerant charge per circuit (5)	(kg)	8.0	8.0	8.4	8.4	9.2	9.6	9.6
Oil quantity per circuit (5)	(kg)	6.6	6.6	7.2	9.7	12.2	12.2	12.2

(1) According to EN-14511:2018 - indoor: 27°C/19°C, outdoor: 35°C (cooling), Indoor: 20°C, outdoor 7°C/6°C DB/WB (heating)

(2) At Eurovent conditions, with 1pW reference sound power, according to ISO9614

(3) With low ambient temperature option

(4) Without auxiliary heat

(5) Refrigerant and oil charge values are not binding, please check the effective quantity of refrigerant shown on unit nameplate.

* Out of scope of Eurovent certification programme

Cooling only units (IC models) – R410A

Size		140	150	170	190	220*	250*	270*
Indoor fan								
Nominal airflow	(m ³ /h)	24000	26000	28000	33000	36000	42000	44000
Minimum airflow	(m ³ /h)	19200	20800	22400	26400	28800	33600	36800
Maximum airflow	(m ³ /h)	28800	31200	33600	39600	42000	44000	44000
Type		EC plug fan						
Number of fans		3	3	3	4	4	4	4
Maximum power input (standard)	(kW)	3.5	3.5	5.7	3.5	5.7	5.7	5.7
Available static pressure at nominal flow rate	(Pa)	400	400	400	400	400	400	400
with oversized drive	(Pa)	800	800	800	800	800	800	800
Outdoor fan								
Type		Axial						
Number		4	4	4	4	4	6	6
Total airflow	(m ³ /h)	53560	53560	53560	66816	66816	95484	95484
Performance data (cooling mode)								
Net cooling capacity (1)	(kW)	141.5	155.5	172.9	196.4	212.9	233.7	247.0
Total power input	(kW)	42.6	49.9	57.1	69.7	81.3	87.4	94.0
Net EER	(kW/kW)	3.32	3.12	3.03	2.82	2.62	2.67	2.63
Seasonal space efficiency in cooling	(%)	191.0	181.8	175.0	161.4	147.2	147.2	138.2
SEER	(kW/kW)	4.85	4.62	4.45	4.11	3.76	3.76	3.53
SEER Class		A	B	B	B	-	-	-
General data								
Compressor type		Variable volume scroll						
Number of circuits / compressors		2 / 2	2 / 2	2 / 2	2 / 2	2 / 2	2 / 2	2 / 2
Refrigerant charge per circuit (5)	(kg)	10.0	10.0	10.5	10.5	11.5	12	12
Oil quantity per circuit (5)	(kg)	6.6	6.6	7.2	9.7	12.2	12.2	12.2

(1) According to EN-14511:2018 - indoor: 27°C/19°C, outdoor: 35°C (cooling), Indoor: 20°C, outdoor 7°C/6°C DB/WB (heating)

(2) At Eurovent conditions, with 1pW reference sound power, according to ISO9614

(3) With low ambient temperature option

(4) Without auxiliary heat

(5) Refrigerant and oil charge values are not binding, please check the effective quantity of refrigerant shown on unit nameplate.

* Out of scope of Eurovent certification programme

Acoustic data – standard noise units

		140	150	170	190	220	250	270
A-weighted Outdoor sound power level (2)	(dB(A))	85	85	86	91	91	92	92
A-weighted sound power level in duct (2)	(dB(A))	85	89	91	85	87	94	96

Auxiliary heat general data

Size		140	150	170	190	220	250	270
Electric Heater								
Number of capacity step		2	2	2	2	2	2	2
Capacity Steps	kW	37,5/ 37,5	37,5/ 37,5	62,5/ 37,5	62,5/ 37,5	75/ 37,5	75/ 37,5	75/ 37,5
Gas burner: Low Heat								
Module model		PCH132	PCH132	PCH132	PCH132	PCH132	PCH132	PCH132
Max. burner heat output G20 (Hi)	kW	130	130	130	130	130	130	130
Max. useful heat output G20	kW	126	126	126	126	126	126	126
Max. efficiency G20 (Hi)	%	96.8	96.8	96.8	96.8	96.8	96.8	96.8
Min. burner heat output G20 (Hi)	kW	12.4	12.4	12.4	12.4	12.4	12.4	12.4
Min. useful heat output G20	kW	13.4	13.4	13.4	13.4	13.4	13.4	13.4
Min. efficiency G20 (Hi)	%	108.1	108.1	108.1	108.1	108.1	108.1	108.1
Modulation	%	11% to 100%						
Max. condensation (30%Qn)	l/h	4.2						
Gas connection Æ		UNI/ISO 228/1-G 1½"						
Gas burner: Standard Heat								
Module model		PCH162	PCH162	PCH162	PCH162	PCH162	PCH162	PCH162
Max. burner heat output G20 (Hi)	kW	164	164	164	164	164	164	164
Max. useful heat output G20	kW	160	160	160	160	160	160	160
Max. efficiency G20 (Hi)	%	97.6	97.6	97.6	97.6	97.6	97.6	97.6
Min. burner heat output G20 (Hi)	kW	16.4	16.4	16.4	16.4	16.4	16.4	16.4
Min. useful heat output G20	kW	17.8	17.8	17.8	17.8	17.8	17.8	17.8
Min. efficiency G20 (Hi)	%	108.4	108.4	108.4	108.4	108.4	108.4	108.4
Modulation	%	11% to 100%						
Max. condensation (30%Qn)	l/h	6.6	6.6	6.6	6.6	6.6	6.6	6.6
Gas connection Æ		UNI/ISO 228/1-G 1½"						
Gas burner: High Heat								
Module model		PCH212	PCH212	PCH212	PCH212	PCH212	PCH212	PCH212
Max. burner heat output G20 (Hi)	kW	200.0	200.0	200.0	200.0	200.0	200.0	200.0
Max. useful heat output G20	kW	194.3	194.3	194.3	194.3	194.3	194.3	194.3
Efficiency G20 (Hi)	%	97.2	97.2	97.2	97.2	97.2	97.2	97.2
Min. burner heat output G20 (Hi)	kW	21	21	21	21	21	21	21
Min. useful heat output G20	kW	22.8	22.8	22.8	22.8	22.8	22.8	22.8
Min. efficiency G20 (Hi)	%	108.4	108.4	108.4	108.4	108.4	108.4	108.4
Modulation	%	11% to 100%						
Max. condensation (30%Qn)	l/h	5.4						
Gas connection Æ		UNI/ISO 228/1-G 1½"						
Hot Water Coil								
Gross Heating Capacity	kW	152	159	165	180	188	188	188
Net Heating Capacity	kW	155	162	169	185	194	194	194
Type		Fins & Tubes						
Tube Size	"	3/8"	3/8"	3/8"	3/8"	3/8"	3/8"	3/8"
Face Area	m ²	1.39	1.39	1.39	1.39	1.39	1.39	1.39

Electric data – R410A & R454B

Size		140	150	170	190	220	250	270
Main Power Supply	V/Ph/Hz	400 / 3 / 50						
Unit Max Amps	A	118	128	154	170	203	224	239
Unit Start Up Amps (without soft starter)	A	250	296	331	384	417	484	578
Unit Start Up Amps (with soft starter)	A	195	227	255	293	326	372	434
Maximum Short Circuit rating for 0,3 sec	kA	15	15	15	15	15	15	15
Extra Amps								
Electric Heater	A	108	108	144	144	162	162	162
Outdoor fan : Low Ambient	A	3.1	3.1	3.1	0.4	0.4	0.6	0.6
Indoor fan : Oversized	A	11.1	11.1	9.0	14.8	0.0	0.0	0.0
Exhaust Fan	A	9.4	9.4	9.4	9.4	9.4	9.4	9.4
Return Roofcurb	A	13.2	13.2	13.2	22.0	22.0	22.0	22.0
Heat Recovery (not included current for oversized fan)	A	12.9	12.9	12.9	12.9	12.9	12.9	12.9
Heat Recovery - High airflow (not included current for oversized fan)	A	21.9	21.9	21.9	21.9	21.9	21.9	21.9
Gas burner - modulation – PCH132	A	0.8	0.8	0.8	0.8	0.8	0.8	0.8
Gas burner - modulation – PCH162	A	1.1	1.1	1.1	1.1	1.1	1.1	1.1
Gas burner - modulation – PCH212	A	1.1	1.1	1.1	1.1	1.1	1.1	1.1

Operating limits – R410A & R454B

The operation limits of a rooftop unit are determined by the outdoor (ambient) air temperature and the mixed return air temperature. The latter is defined between as the mixture between return air from inside the building, and the fresh air introduced from outside the building. The performance of the unit depends on indoor and outdoor conditions, as well the options selected. For a detailed selection at project conditions, contact your local Trane sales engineer.

For selections at high ambient conditions, please contact your local Trane sales engineer.

Table 5 – Airfinity operating limits

Temperature range	min °C	max °C
Cooling mode		
Outdoor air temperature	10	46
Outdoor air temperature (1)	-20	46
Mixed return air temperature	15	35
Heating mode		
Outdoor air temperature	-15	20
Outdoor air temperature (2)	-25	20
Bivalent temperature	(depends on unit)	
Mixed return air temperature	5	26

(1) With low ambient kit (EC outdoor fans)

(2) With auxiliary heat

Unit dimensions and weight

Frame 4: sizes 140 to 220

Width on all units: 2310 mm

Unit dimensions – basic version

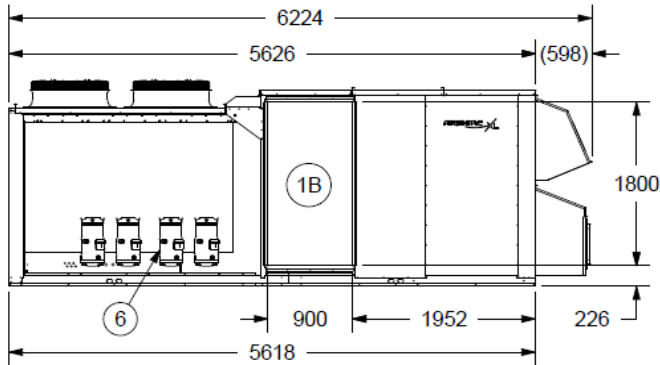

Unit dimensions – with gas burner

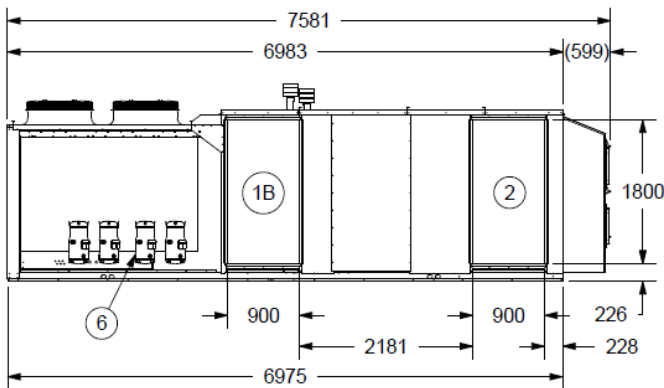

Unit dimensions – with ERM and with/without gas burner

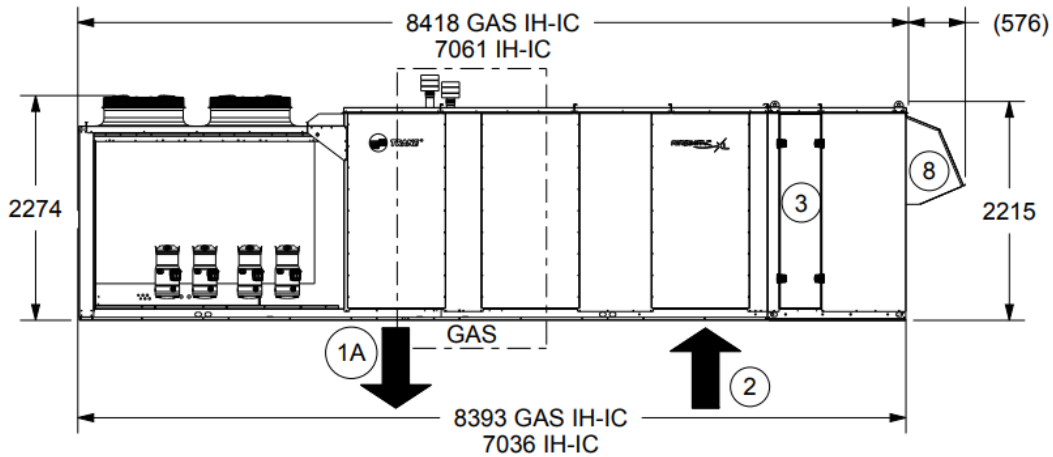

Frame 5: sizes 250 to 270

Width on all units: 2310 mm

Unit dimensions – basic version

With ERM: add

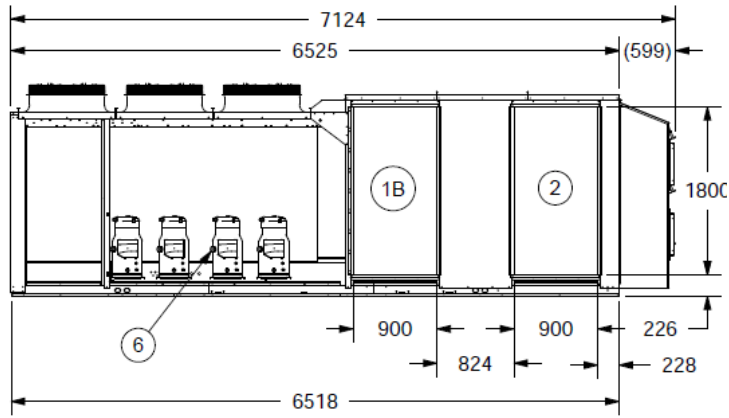

Unit dimensions – with gas burner

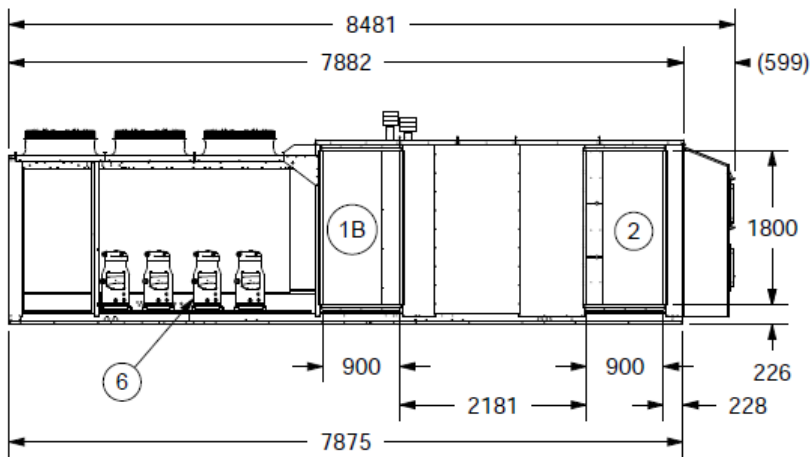

Unit dimensions – with ERM and with/without gas burner

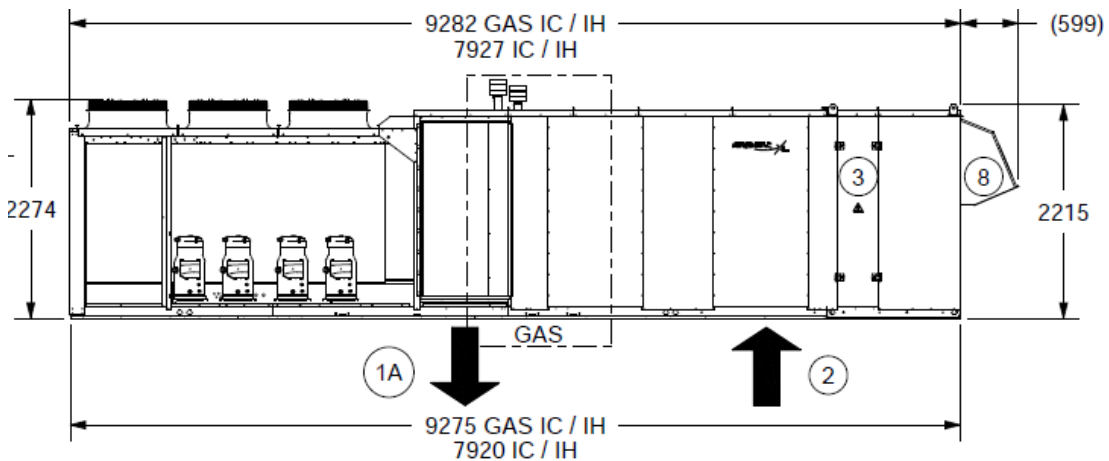



Table 6 – Airfinity XL dimensions and weight

Size		140	150	170	190	220	250	270
Length (including fresh air hood)	mm	6224	6224	6224	6224	6224	7118	7118
Width	mm	2350	2350	2350	2350	2350	2350	2350
Height	mm	2274	2274	2274	2274	2274	2274	2274
Operating Weight (Downflow Without Auxiliary Heat) - IC	kg	2393	2401	2519	2630	2703	2918	2922
Operating Weight (Downflow Without Auxiliary Heat) - IH	kg	2335	2503	2561	2672	2744	2939	2942
Options – incremental length								
Gas burner module	mm	1357	1357	1357	1357	1357	1357	1357
Energy recovery module (ERM)	mm	1750	1750	1750	1750	1750	1750	1750
Options – incremental weight								
Hot Water Coil	kg	60	60	60	60	60	60	60
Electric Heater	kg	26	26	26	26	26	26	26
Gas Burner low Heat	kg	382	382	382	382	382	382	382
Gas Burner Standard Heat	kg	434	434	434	434	434	434	434
Gas Burner High Heat	kg	474	474	474	474	474	474	474
Energy Recovery Module Standard	kg	646	646	646	646	646	646	646
Energy Recovery Module High Airflow	kg	695	695	695	695	695	695	695
Exhaust Fan EC	kg	127	127	127	127	127	127	127
Return Roofcurb Downflow	kg	755	755	755	783	783	783	783



Trane - by Trane Technologies (NYSE: TT), a global climate innovator - creates comfortable, energy efficient indoor environments for commercial and residential applications. For more information, please visit trane.com or tranetechnologies.com.

Trane has a policy of continuous product and product data improvement and reserves the right to change design and specifications without notice. We are committed to using environmentally conscious print practices.

RT-PRC089C-GB January 2022
Supersedes RT-PRC089B-GB_1219

© 2022 Trane