



Controller User Guide

For chillers and heat pumps with IPro controller



June 2020

PROD-SVU001C-GB

TRANE
TECHNOLOGIES

Table of Contents

GENERAL INFORMATION	3
1. ADVANCED CONTROL	4
2. CONTROL HARDWARE ARCHITECTURE	5
3. LARGE OPERATOR INTERFACE	8
4. LED OPERATOR INTERFACE	31
5. UNIT ACTIVATION	52
6. TEMPERATURE CONTROL	53
7. WATER PUMPS MANAGEMENT	61
8. LOW WATER FLOW ALARM MANAGEMENT	64
9. WATER FREEZE PROTECTION MANAGEMENT	66
10. CONDENSING FANS MANAGEMENT	68
11. SAFETY UNLOADING	71
12. DEFROST MANAGEMENT	72
13. ENERGY SAVING AND AUTO ON / OFF	73
14. DYNAMIC SET POINT	74
15. LOG FILES MANAGEMENT	75
16. REMOTE CONTROL	77

General information

The information in this manual is valid for chillers and heat pumps units equipped with advanced controller with software and bios release starting from:

BIOS RELEASE: **2017011600**

APPLICATION RELEASE: **2.0Idronico_a**

This information is visible in the **Home** section of controller web page.

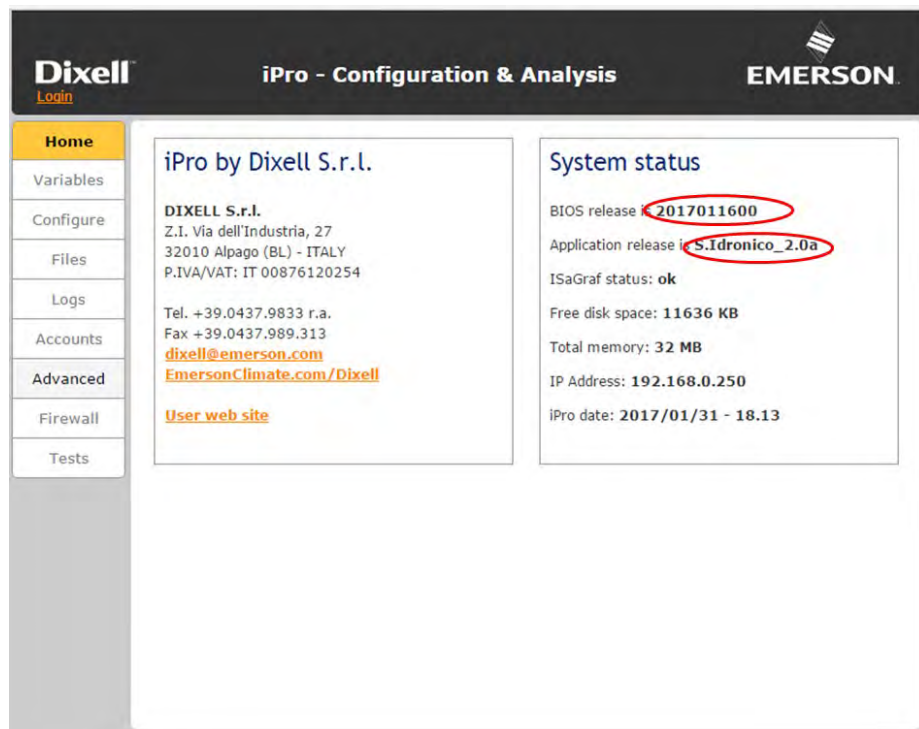

The screenshot displays the iPro Configuration & Analysis web interface. The top navigation bar includes the Dixell logo with a 'Login' link, the title 'iPro - Configuration & Analysis', and the Emerson logo. A left sidebar menu contains options: Home (highlighted), Variables, Configure, Files, Logs, Accounts, Advanced, Firewall, and Tests. The main content area is divided into two panels. The left panel, titled 'iPro by Dixell S.r.l.', provides contact information for DIXELL S.r.l., including address, phone, fax, email, and website. The right panel, titled 'System status', lists key system metrics: BIOS release (2017011600), Application release (S.Idronico_2.0a), ISaGraf status (ok), Free disk space (11636 KB), Total memory (32 MB), IP Address (192.168.0.250), and iPro date (2017/01/31 - 18.13). The BIOS and Application release values are circled in red in the original image.

Section	Item	Value	
System status	BIOS release	2017011600	
	Application release	S.Idronico_2.0a	
	ISaGraf status	ok	
	Free disk space	11636 KB	
	Total memory	32 MB	
	IP Address	192.168.0.250	
	iPro date	2017/01/31 - 18.13	
	iPro by Dixell S.r.l.		
	DIXELL S.r.l. Z.I. Via dell'Industria, 27 32010 Alpago (BL) - ITALY P.IVA/VAT: IT 00876120254		
	Tel. +39.0437.9833 r.a. Fax +39.0437.989.313 dixell@emerson.com EmersonClimate.com/Dixell User web site		

1. Advanced Control

The control logic of chillers and heat pumps, allows to satisfy the heating and the cooling plant loads, according to the selected operating mode, automatically modulating the capacity of the unit.



2. Control Hardware Architecture

IPG315D

Power supply: 24V AC/DC

Digital inputs: 20 opto-insulated at 24Volt AC current on the contact

Analogue inputs 10 configurables: 0÷5V, 4÷20mA, NTC, PTC, digital input

Analogue outputs Opto-Insulated

2 configurable: 0-10V, external relay driving, PWM signal

4 configurables: 0-10V signal, external relay driving

Relay outputs: 10 x 5(2) A @ 250V SPST + 5 SSR type

Remote terminal: 1 output for connection of up to two remote terminals (100M)

RTC

Serial outputs

1 USB

1 Ethernet with Bacnet TCP/IP communication protocol

1 connector for/GSM modem /XWEB modem

1 RS485 master with ModBUS communication protocol

1 RS485 slave with ModBUS or BACnet MSTP communication protocol

1 CANbus to connect I/O expansion modules

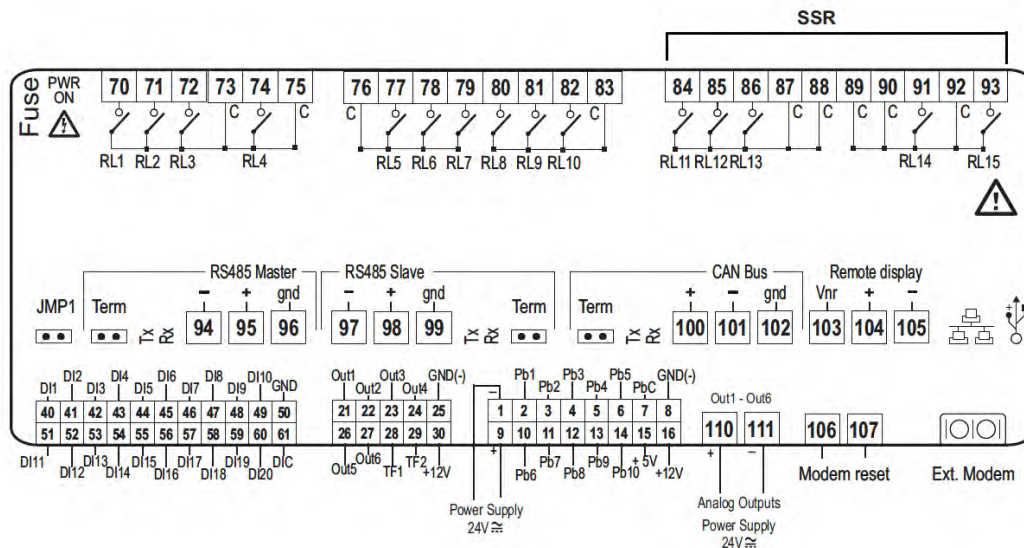

IPG108D / IPG108E:

Power supply: 24V AC/DC

Digital inputs: 11 opto-insulated at 24Volt AC current on the contact

Analogue inputs: 6 configurable: 0÷5V, 4÷20mA, NTC, PTC, digital input

Analogue outputs Opto-Insulated: 4 configurable: 0÷10V signal, external relay driving

Relay outputs: 8 x 5(2) A @ 250V SPST

Remote terminal: 1 output for connection of up to two remote terminals (100M)

RTC

LED DISPLAY INTEGRATED (IPG108E)

Serial outputs

1 USB; BACnet IP using USB/Ethernet adapter

1 RS485 master with ModBUS communication protocol in case of the controller is the MASTER or 1 LAN to connect I/O expansion module

1 RS485 slave with ModBUS or with BACnet MSTP communication protocol in case of the controller is the SLAVE

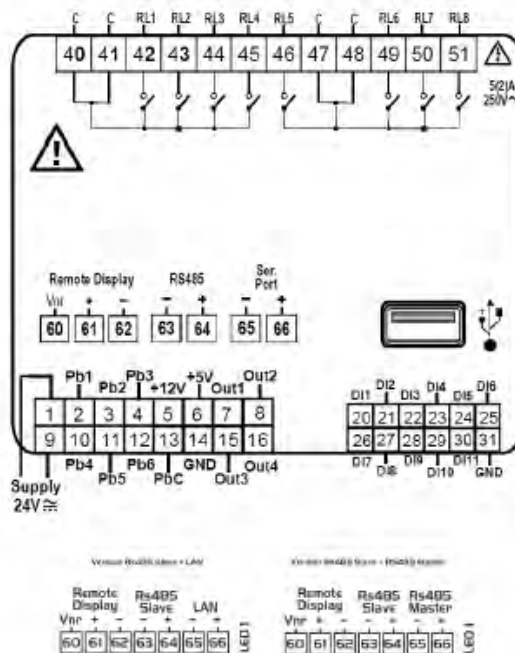

IPX106D:

Power supply: 24V AC/DC

Digital inputs: 3 opto-insulated

Analogue inputs: 7 configurable: 0÷5V, 4÷20mA, NTC, PTC, digital input

Analogue outputs Opto-Insulated: 3 configurable: 0÷10V signal, external relay driving

Relay outputs: 6 x 5(2) A @ 250V SPST

Serial outputs

1 CANbus to connect to IPG315D

1 LAN to connect to IPG108D or IPG108E

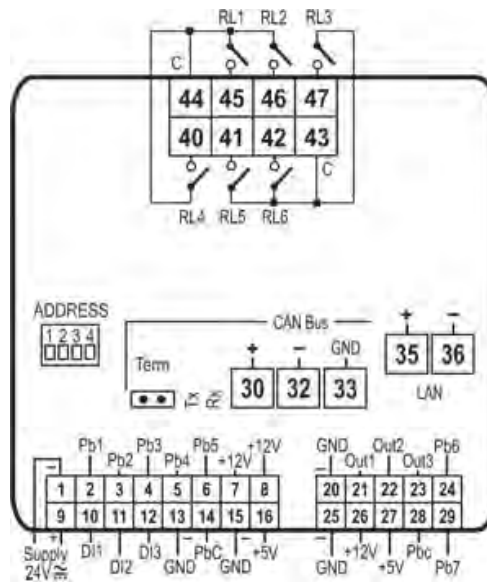

3. Large Operator Interface

Large chillers and heat pumps are equipped with a visual LCD keyboard, through which it is possible to monitor and to modify the status and settings of the unit. For smaller units this is available as “**Remote Keypad**”.







3.1. Main Screen

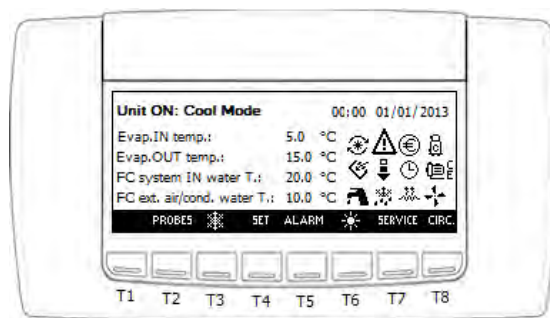



Information reported on the main screen is related to the “Unit status”, to the current date and to the user and source side water temperatures or ambient temperature:

- Chilled water Return temperature
- Chilled water Leaving temperature
- Hot water Return temperature
- Hot water Leaving temperature



Generic info related to the main components or special functions status is also reported in the main screen through icons:

-  to indicate that at least one of the compressors is working.
-  to indicate that the evaporator pump (**E**) and/or the recovery (**R**) pump and/or source pump (**C**) (in case of water-cooled unit) are working.
-  to indicate that the condenser fans are working (in case of air-cooled unit).
-  flashing to indicate that at least an alarm is active

-  to indicate that the safety capacity reduction mode is in progress
-  to indicate that the defrost cycle is in progress, flashing during the count down
-  to indicate that the anti-freeze/support heaters are active
-  automatic switch-off and/or energy saving is enabled during the current day
-  to indicate that the unit is working within the energy saving function or that the dynamic set-point is active

3.2. Keyboard structure

Information on keypad is divided in different menus and sub-sections. The most researched have a direct link with the main screen by using quick dial keys; the most specific information referred to the status of the components or to the status of functions, instead, is reported in specific menus into “**SERVICE**” branch.

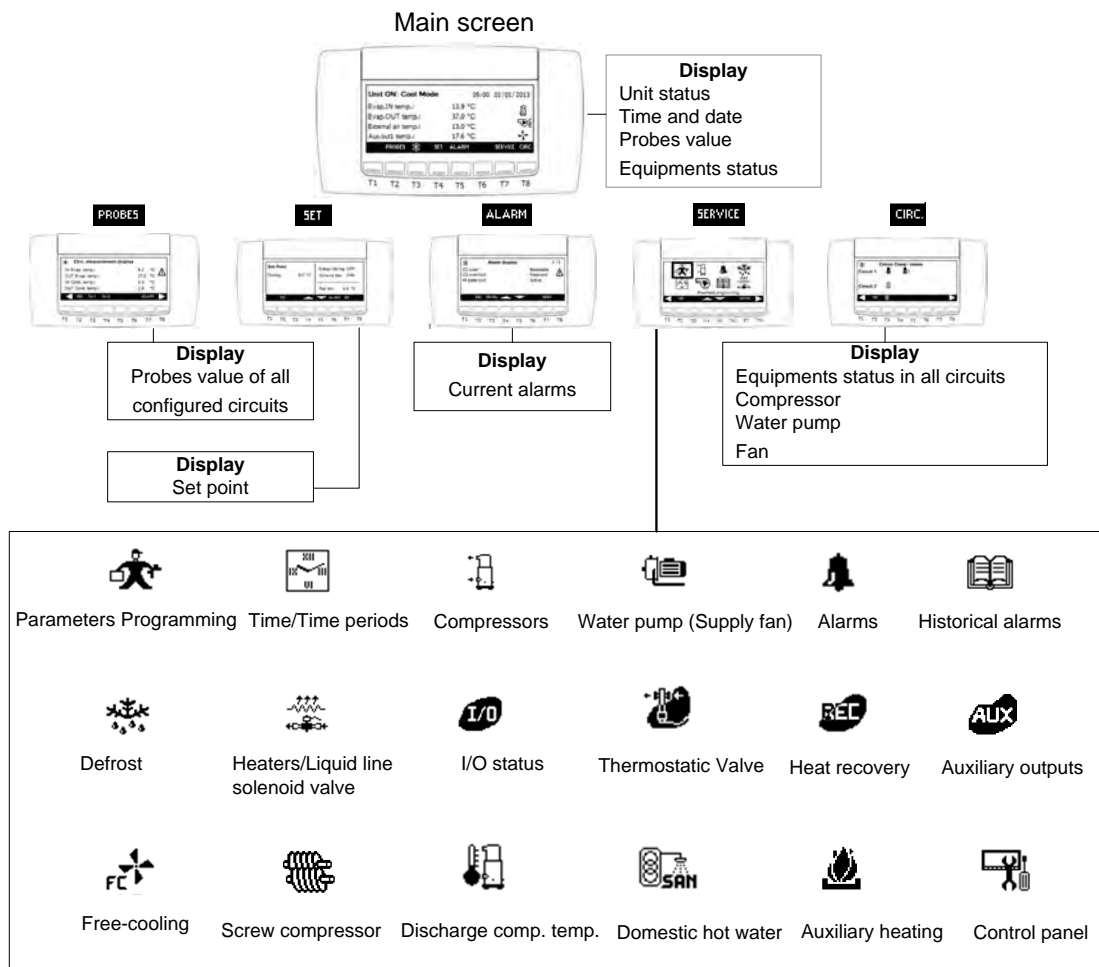

3.3. Quick link Sections

3.3.1. Probes Section

In the Probes section, accessible pressing the **PROBES** key in the main screen, all configured sensors are displayed in different pages. They are reachable using T1 and T8 buttons

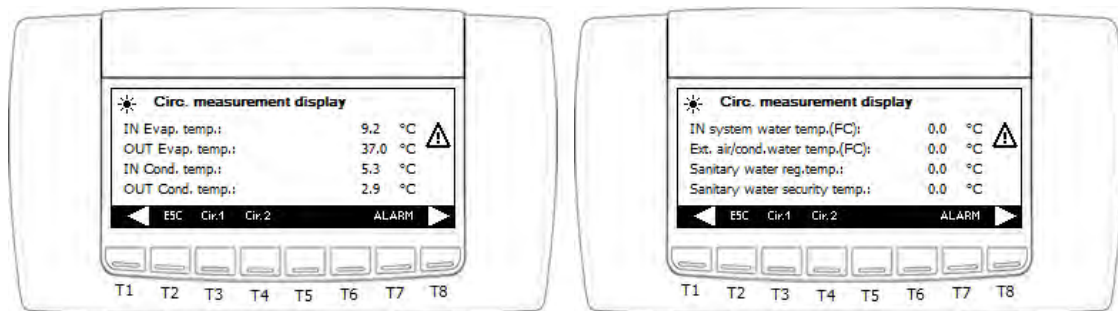

From this section, pressing the **Cir"x"** button, it is possible to enter in the specific circuit sub-section of the configured circuit n° "x", where its relevant refrigerant variables are displayed.

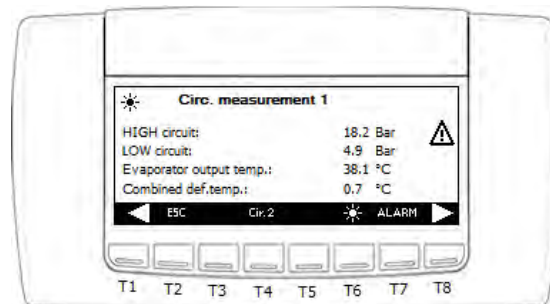

3.3.2. Set Point Section

In the Set Point section it is possible to edit the water set-points.

This tab has a direct link with the main screen through the **SET** button.

In this screen the notifications about the status of the **ENERGY SAVING**, **DYNAMIC SET POINT** and **POWER LIMIT** functions are also reported.

Cooling and Heating sets are the parameters **ST01** and **ST04**.

The real set represents, instead, the set-point value including the energy saving delta or the dynamic set delta, and it cannot be modified.

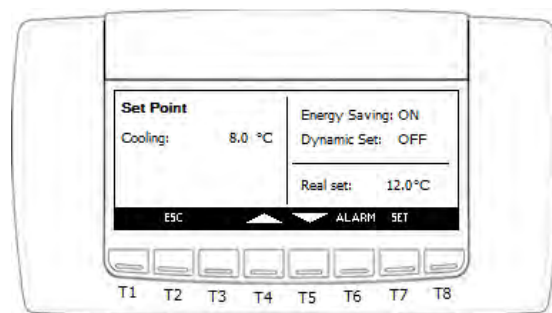

Set points of secondary users, as heat recovery or domestic hot water, will be displayed too, if they are configured:

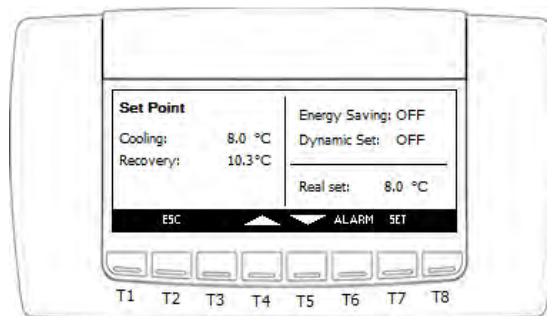

HOW TO EDIT SET POINTS

To modify the set point, select the desired one using **UP** and **DOWN** buttons and press **SET** to enable the editing. The element starts to flash.

Increase or decrease the value using the **UP** and **DOWN** keys and press again **SET** to confirm the new value.

The cursor will pass automatically to the next element of the list. To modify it, repeat the operation just described above.

Press the **ESC** key to go back to the main screen.

3.3.3. Alarm Section

When an alarm occurs, the display shows the flashing icon , the alarms key starts to flash alternately with the icons **ALARM** / **PRESS** and the buzzer starts to operate.

Pressing any key it is possible to turn off the buzzer, to pass to the alarm in progress section it is necessary to press the “**Alarm**” button.

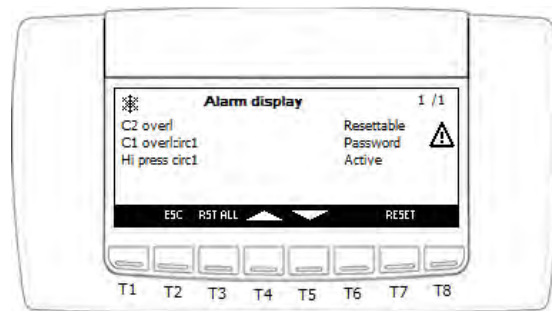

Alarms could have three different status:

- **Active** → the alarm is still in progress.
- **Resettable** → in this case, the alarm is not active and can be reset.
- **Password** → in this case, the alarm is not active, but a password is required to reset it.

HOW TO RESET AN ALARM

To reset an alarm, select the desired one using **UP** and **DOWN** buttons and press **RESET**

If the selected one requires to insert a password, a new screen will appear where pressing “+” and “-” keys it is possible to insert the value. The **ENTER** button is the confirmation one.

If the inserted password is correct, the message below will be displayed and after few seconds automatically it will come back to the current alarm screen.

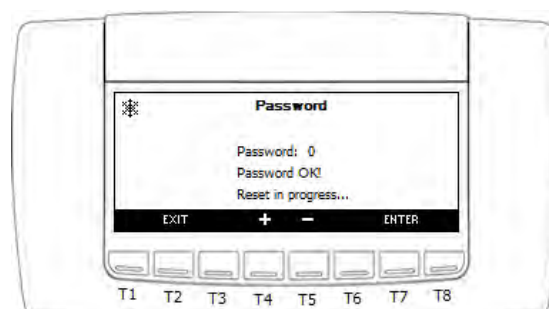

If there are several resettable alarms, instead of selecting them one by one, pressing **RST ALL** they will be

reset all together.

Press the **ESC** key to go back to the main screen.

3.3.4. Circuits Info Section

Using the **CIRC** key in the main screen it is possible to monitor the situation of the unit.

The information refers to:

- **Circuits compressors status:** the screen shows the compressors present for each circuit, their activation status and the number of the unloading steps active, in case of compressors have partialization valves. If the compressor has no number on the right, it means that it is at full power.

It is shown, also, the notification of the activation of the safety special functions, as oil boost or safety unloading.

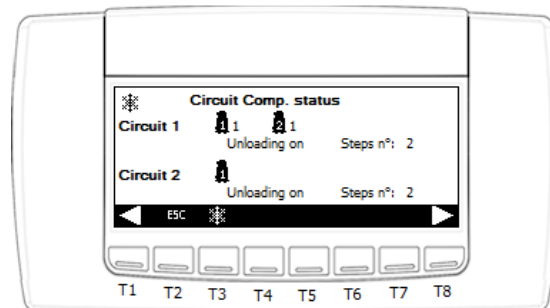

- **Condensation-evaporation probes:** The screen shows the condensation and evaporation pressures of every circuit present.

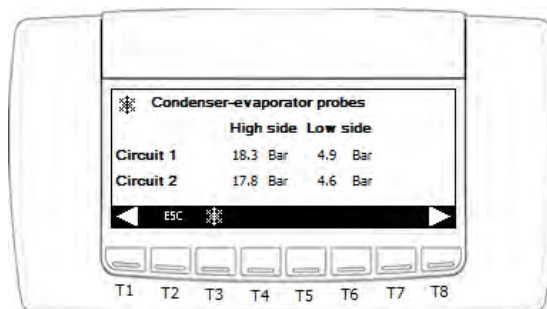

- **Status of the evaporator pump** (or evaporator pumps if the support one is present).

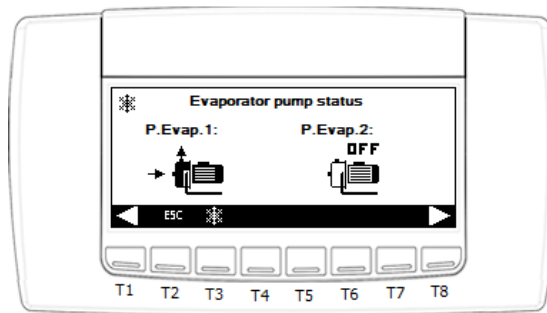

- **Status of the recovery pump** (or recovery pumps if the support one is present)

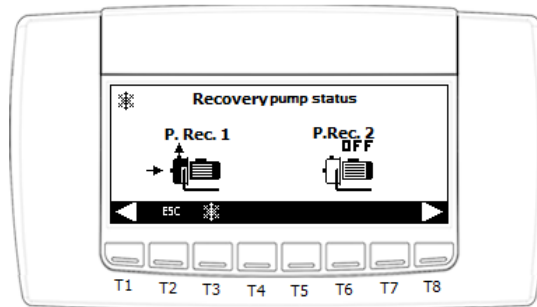

- **Status of the condenser/source pump on water-cooled units** (or condenser/source pumps if the support one is present)

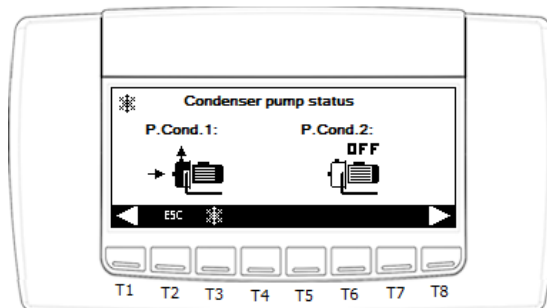

- **Condensation fans on air-cooled units** (proportional or steps regulation).

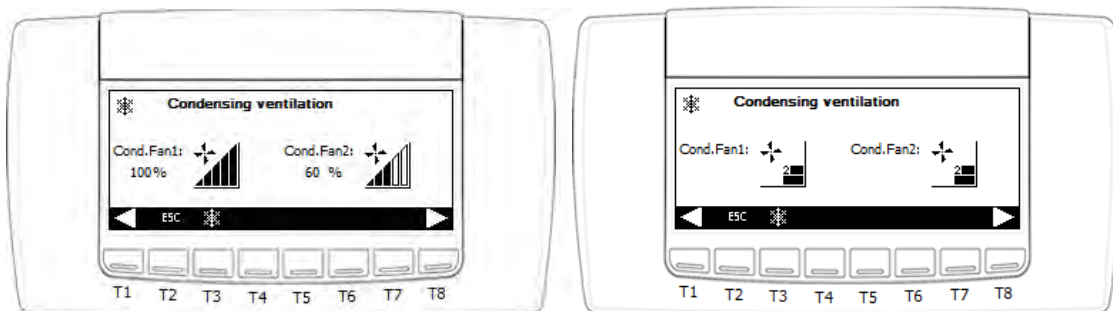

3.4. Service branch

The “**SERVICE**” branch has 3 different access levels.

The 1st or **USER** level does not require password. The access to the higher levels **LV2** and **LV3**, instead, is protected.

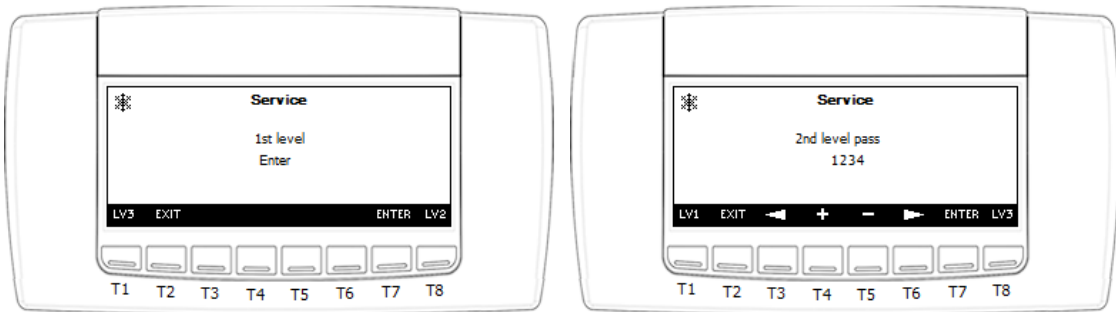

3.4.1. Parameters Programming

In this menu it is possible to modify the value of the parameters.

According to the account level, different amount of parameters are visible and editable.

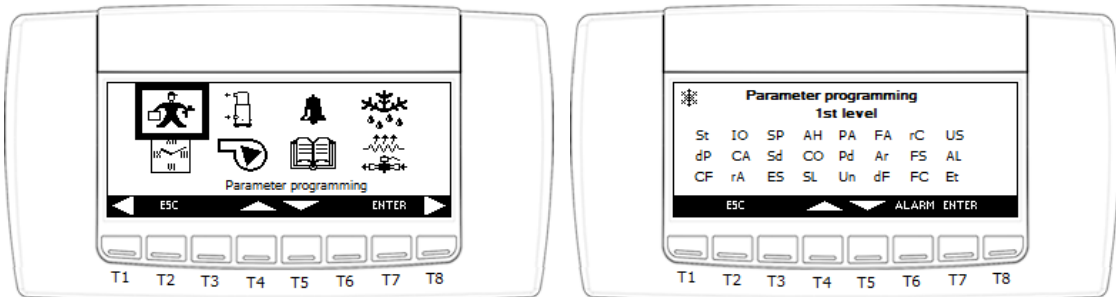

Parameters are divided in groups with the following meaning:

Label	Meaning
ST	Displays temperature control parameters
DP	Displays variables to be shown on main screen of the keyboard
CF	Displays configuration parameters
SP	Displays parameters for machine set up
Sd	Displays dynamic set-point parameters
ES	Displays energy saving and automatic timed switch-on/off parameters
AH	Displays auxiliary heating parameters
CO	Displays compressor parameters and timings
SL	Displays stepless compressor parameters

PA	Displays evaporator/condenser water pump parameters
Pd	Displays pump down function parameters
Un	Displays unloading function parameters
FA	Displays ventilation parameters
Ar	Displays anti-freeze heaters parameters
dF	Displays defrost parameters
rC	Displays heat recovery parameters
FS	Displays production of domestic hot water parameters
FC	Displays free-cooling function parameters
US	Displays auxiliary output parameters
AL	Displays alarm parameters
Et	Displays parameters for the management of the electronic expansion valve
IO	Displays inputs/outputs configuration parameters
CA	Displays analog input calibration parameters
RA	Displays analog input range parameters

HOW TO EDIT PARAMETERS

To modify a parameter, select the desired one using **UP** and **DOWN** buttons and press **SET** to enable the editing. The element starts to flash and its description will be displayed on the bottom of the page.

Increase or decrease the value using the **UP** and **DOWN** keys and press again **SET** to confirm the new value.

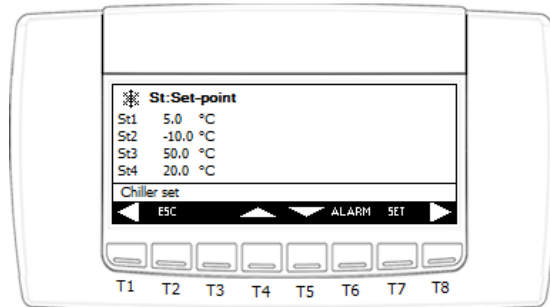

The cursor will pass automatically to the next element of the list. To modify it, repeat the operation just described above.

Press the **ESC** key several times to go back to the main screen.

Warning: The access into groups **CF**, **IO**, **CA** and **RA**, is allowed only if the unit is turned OFF.

3.4.2. Clock settings & Time bands Programming

This menu is used to set the time and date of the microprocessor.

It is also possible to enable or disable the **Energy Saving** and/or the **Automatic on/off** based on time bands.

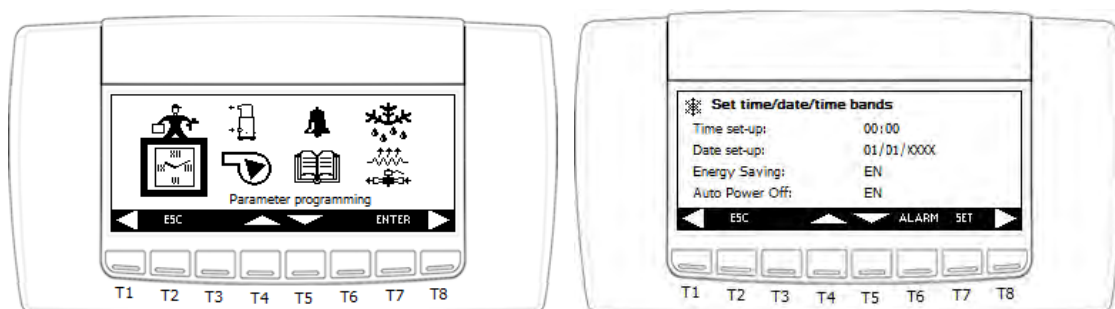

To configure the three time bands and to pass to the **ENERGY SAVING** and/or **AUTO ON/OFF** weekly programming it is necessary to scroll up and down the pages within this submenu using T1 and T8 buttons.

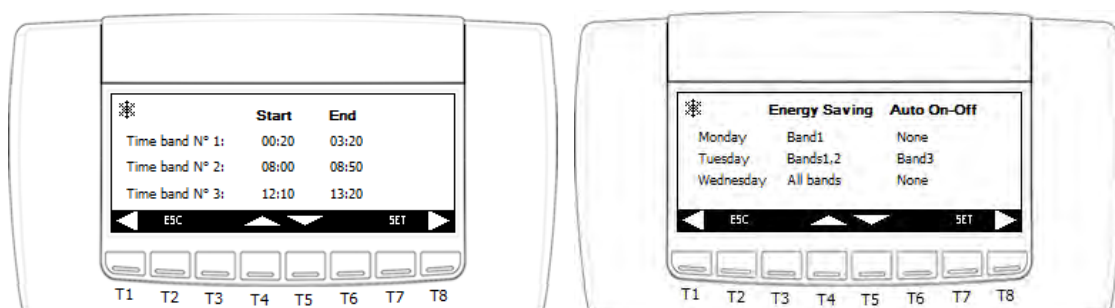

HOW TO EDIT A VALUE

To modify a value, select the desired one using **UP** and **DOWN** buttons and press **SET** to enable the editing. The element starts to flash.

Increase or decrease the value using the **UP** and **DOWN** keys and press again **SET** to confirm the new value. The cursor will pass automatically to the next element of the list. To modify it, repeat the operation just described above.

Press the **ESC** key several times to go back to the main screen.

Warning: The **Automatic on/off** has priority respect the **ENERGY SAVING**.

3.4.3. Compressors Menu

In this submenu the available info for each circuit is:

- Hours worked by each individual compressor
- Number of start-ups for each individual compressor

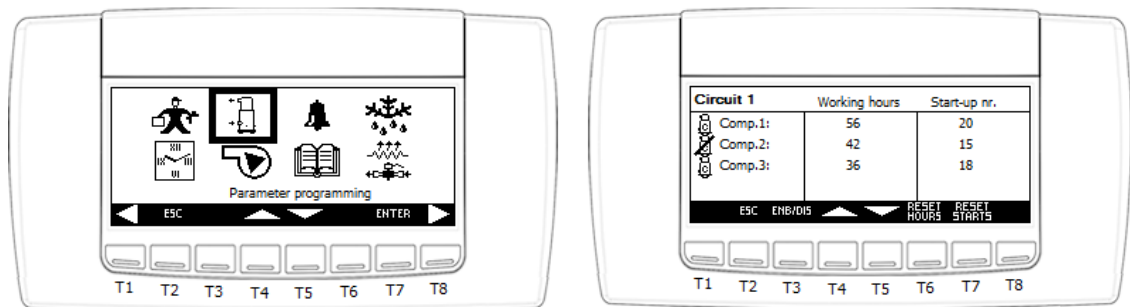

It is possible to reset the value of the working hours or the number of the start-up. These operation are protected by **password**.

It is possible to enable/disable each compressor for maintenance, pressing the key **ENB/DIS**.

HOW TO RESET A VALUE

To reset a value, select the desired one using **UP** and **DOWN** buttons and press **RESET HOURS** or **RESET STARTS**.

The screen where to insert the password using “+” and “-” keys will appear. The **ENTER** button is the one to confirm the password value.

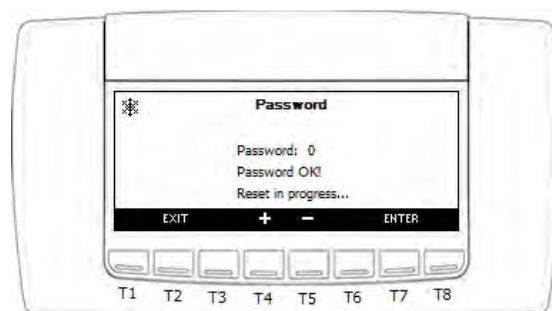

If the inserted password is correct, the value of the hours or of the start-up will be reset and after few seconds automatically the previous page will be displayed again.

3.4.4. Water Pumps Menu

In this submenu the available info is:

- Hours worked by each individual water pump

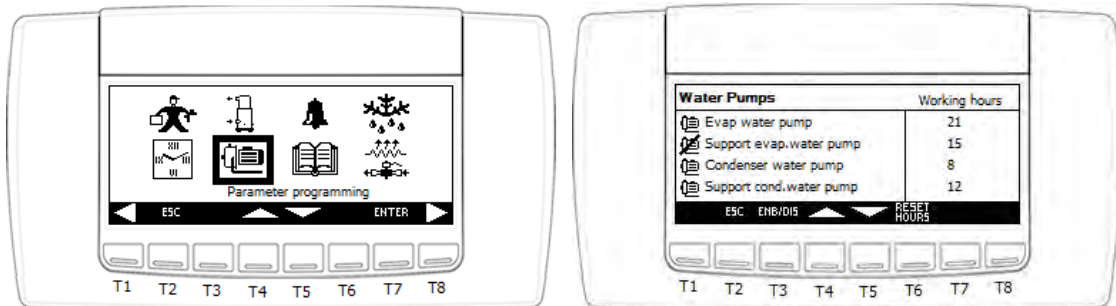

It is possible to reset the value of the working hours. These operation are protected by **password**. It is possible to enable/disable each pump for maintenance, pressing the key **ENB/DIS**.

HOW TO RESET A VALUE

To reset a value, select the desired one using **UP** and **DOWN** buttons and press **RESET HOURS**.

The screen where to insert the password using “+” and “-” keys will appear. The **ENTER** button is the one to confirm the password value.

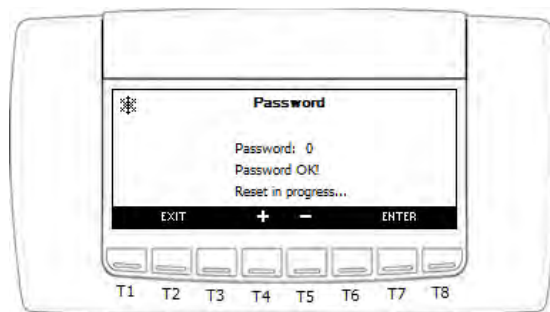

If the inserted password is correct, the value of the hours will be reset and after few seconds automatically the previous page will be displayed again.

Press the **ESC** key several times to go back to the main screen.

3.4.5. Alarms History Menu

All alarms are memorized and displayed in this screen together to the date and the status of the unit when the event occurred.

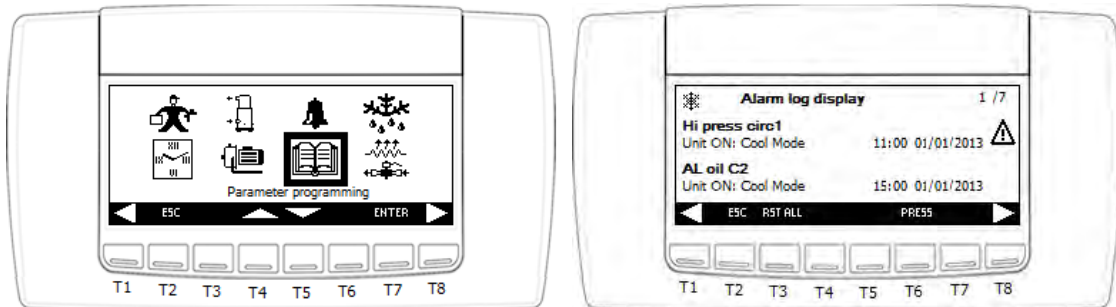

HOW TO RESET ALARMS LOG

To reset the alarms log press **RST ALL**, holding it down for 3 seconds.

The screen where to insert the password using “+” and “-” keys will appear. The **ENTER** button is the one to confirm the password value.

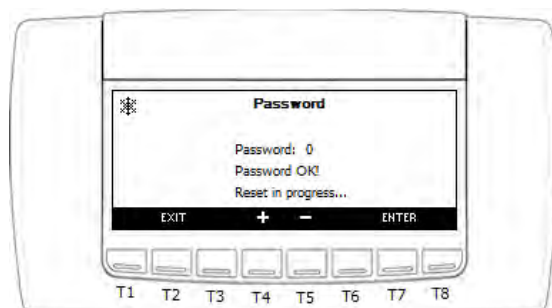

If the inserted password is correct, the alarm list will be reset and after few seconds automatically the previous page will be displayed again.

Press the **ESC** key several times to go back to the main screen.

3.4.6. Defrost Menu

In this menu it is possible to check the status of the “Defrost” cycle for each configured refrigerant circuit.

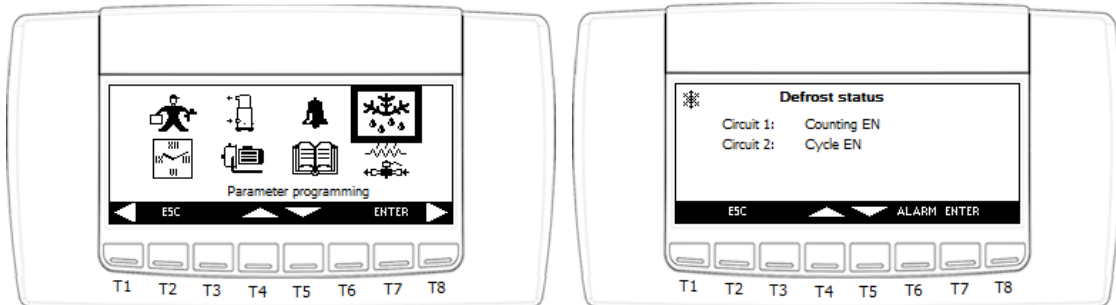

The Defrost status can be:

- **Counting EN:** In counting down, defrost will start soon
- **Cycle EN:** Defrost in progress
- **Drip time EN:** In dripping time
- **Waiting:** Counter is elapsed but defrost is not required so the circuit is in normal working
- **Condition not present:** No necessary condition for defrost

Selecting the circuit, the following screen will be displayed and pressing the  button for 5 seconds, while it is in counting, a manual defrost cycle will be forced.

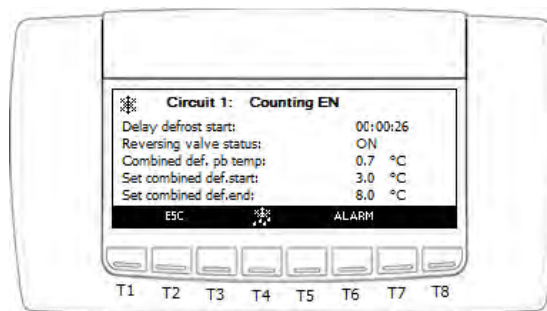

3.4.7. Input / Output Menu

This menu allows to check the **physical** status of all **inputs** and the **logical** status of all **outputs** that have been defined.

The I/O list of the microprocessor is divided by groups, one per type.

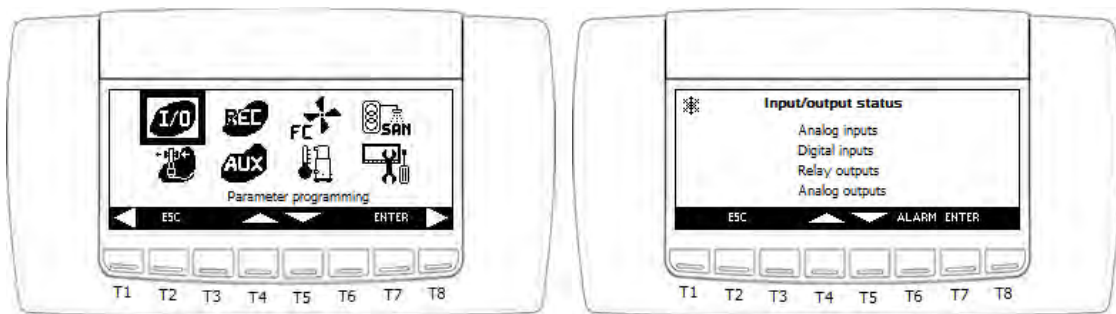

3.4.8. Electronic Expansion valve Menu

In this menu it is possible to check the working status of the electronic expansion valves, configured for each defined circuit. Displayed info for each valve is:

- Suction Temperature
- Suction Pressure
- Opening %
- Superheating Set
- Measured Superheating

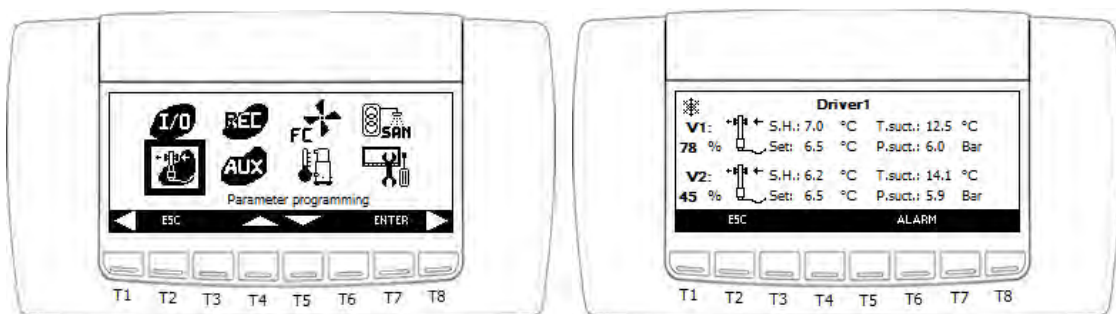

The notification about the status of ExV safety special regulation action will be displayed, as **LOP**, **MOP**, **LSH**, **HSH**.

Warning: This menu is available only if the ExV driver is integrated with the main microprocessor.

3.4.9. TEVI Electronic Expansion valve Menu

In the electronic expansion valve menu it is possible to check the working status of the TEVI electronic expansion valves for vapor injection control, on units where it is configured.

Displayed info for each configured TEVI is:

- Opening % of Valve 1
- Opening % of Valve 2 (if present)
- Superheating vapor injection Set
- Measured Temperature of vapor injection
- Measured Superheating of vapor injection
- Superheating Set
- Measured Pressure of vapor injection
- Saturated Temperature of vapor injection

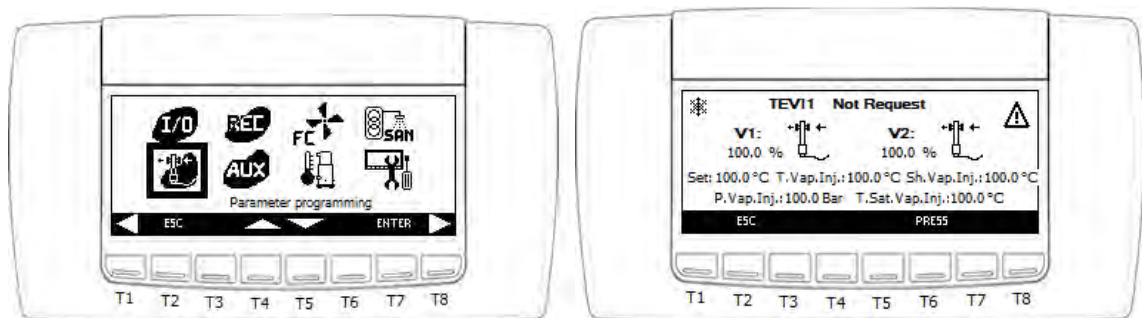

The notification about the mode of the control of ExV TEVI regulation action is displayed, on the top of the page:

- **Ctrl Superheating:**
- **Discharge Temp. Ctrl**
- **Manual Mode**
- **Alarm**

Warning: This menu is available only if the ExV TEVI driver is integrated with the main microprocessor.

3.4.10. Recovery Menu

In this menu it is possible to check the status of the “**Recovery**” function, partial or total, and the notification of configured refrigerant circuits if they are operating in heat recovery mode or not through the “**Rec. Valves**” status.

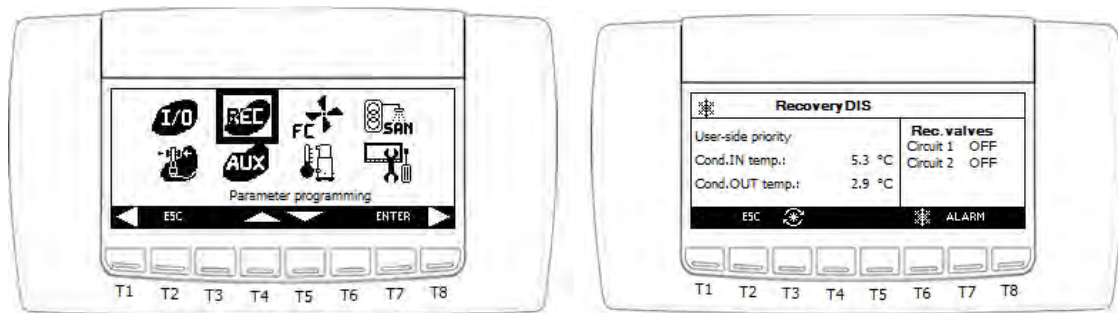

The following information is available in this screen:

- Status of the recovery function:
 - Disabled
 - Disabled from key
 - Enabled
 - Active
- Type of priority:
 - User side
 - Recovery side

Pressing the  key for 1 second it is possible to enable/disable the function by keyboard.

3.4.11. Free-cooling Menu

In this menu it is possible to check the status of the “Free-Cooling” function, and the value of probes and settings related to it.

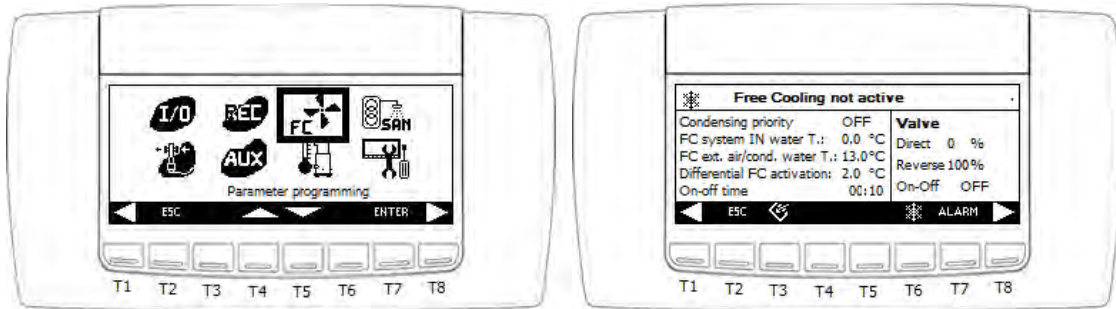

The following information is available in this screen:

- Status of the free-cooling function:
 - Disabled
 - Disabled from key
 - Enabled
 - Active
- Type of priority:
 - Condensing Pressure
 - Free-cooling
 - External ventilation

Pressing the  key for 1 second it is possible to enable/disable the function by keyboard.

3.4.12. Discharge Compressors Menu

In this menu it is possible to monitor the discharge temperatures of the configured compressors.

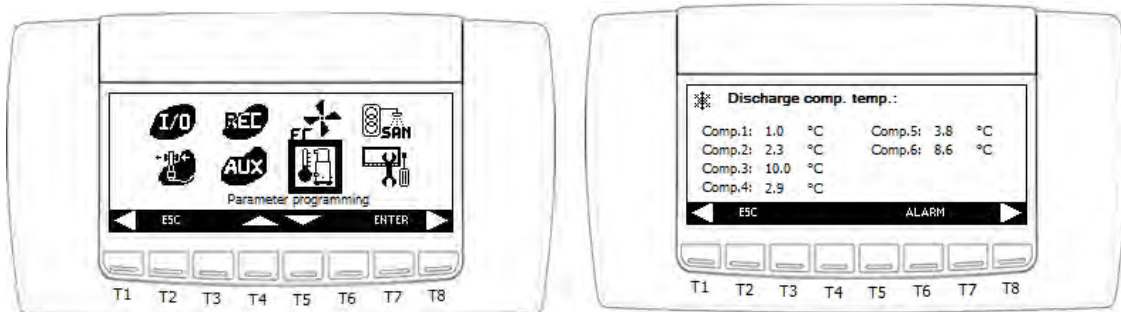

In case of the unit is equipped with **screw compressors**, it is possible to check directly the settings about the intervention point of the **Liquid Injection** and **High Discharge Temperature Alarm**.

Selecting one specific refrigerant circuit and pressing **ENTER** to access, it is possible to check also the measured value of the **Compressor Discharge Gas** sensor and the status of the liquid injection valve and the status of the valve used to reach the minimum partial load.

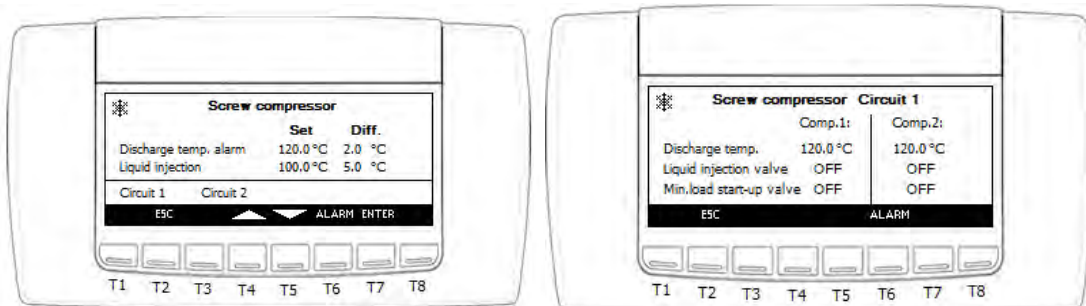

3.4.13. Domestic hot water Menu

In this menu it is possible to check the status of the “Domestic hot water” function, and the value of probes and relevant settings related to it.

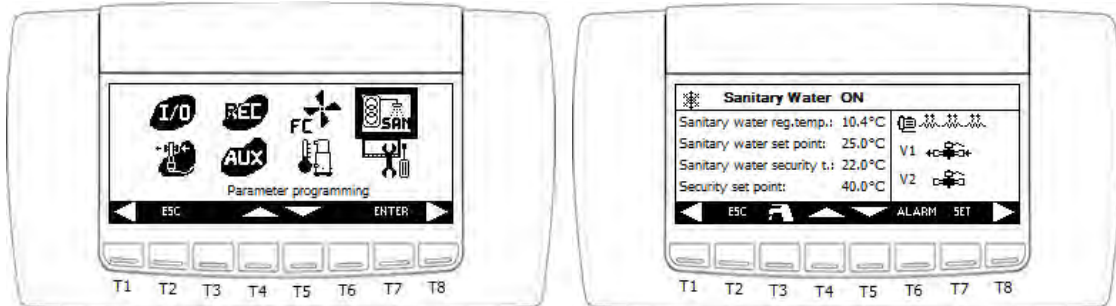

The following information is available in this screen:

- Status of the domestic hot water function:
 - Disabled
 - Disabled from key
 - Not Requested
 - Doing defrost (disabled while defrost cycle is in progress)
 - Changing state (in activation)
 - Active

Pressing the  key for 1 second it is possible to enable/disable the function by keyboard.

3.4.14. Control Panel Menu

Within this menu there are different sub-sections:

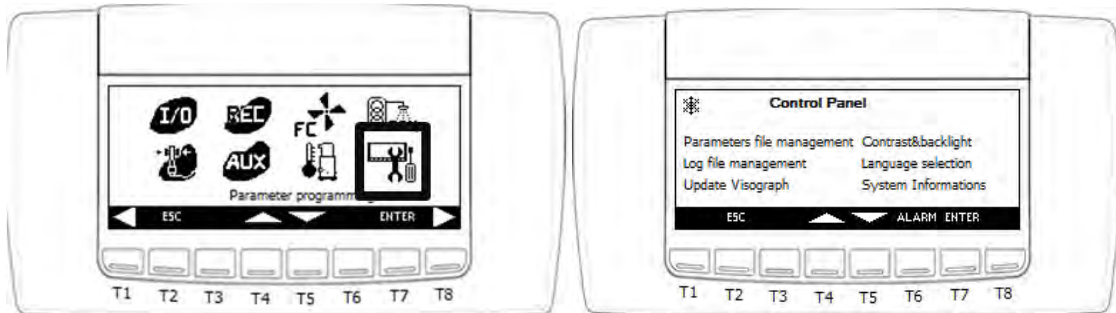

- Parameters file management:

In the memory of the microprocessor are saved 2 files parameters map. One called “**actual**” that represents the **latest saved copy of the parameters map** and another one called “**default**” that represents the **factory settings to erase all preconfigured function**.

Within this subsection it is possible to load and to set as parameters map the last saved copy or to “**default**” one.

Using the 3rd command “**Save as default parameters**” it is possible to **overwrite** the values contained into the “**default**” copy with those contained in latest saved copy or “**actual**”.

Warning: The access in this sub-function is allowed only to the authorized technicians who have been provided with 3rd level password.

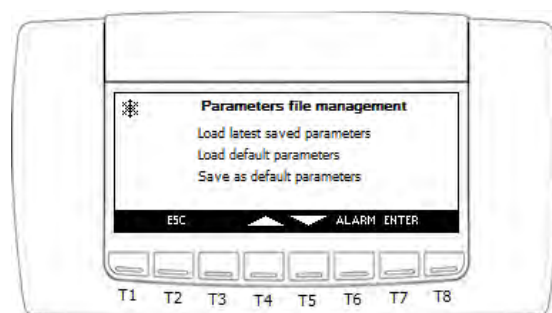

- Contrast & backlight:

Within this subsection it is possible to adjust the label contrast level and the backlight time.

- Log file management:

Within this subsection it is possible to send and to save a copy of log files in an external mass storage, as a USB pen.

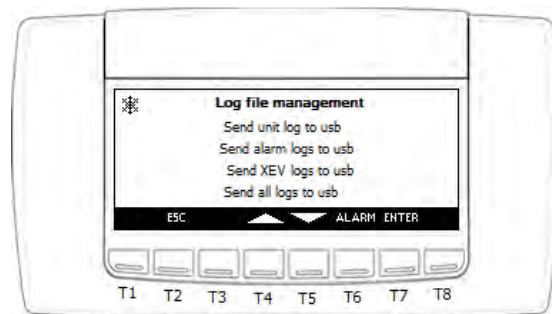

- Update Visograph

In this subsection it is possible to force an updating of the keyboard. If the unit is in on this operation is not allowed.

Warning: Do not remove power supply to the microprocessor and do not disconnect the keypad during the updating.

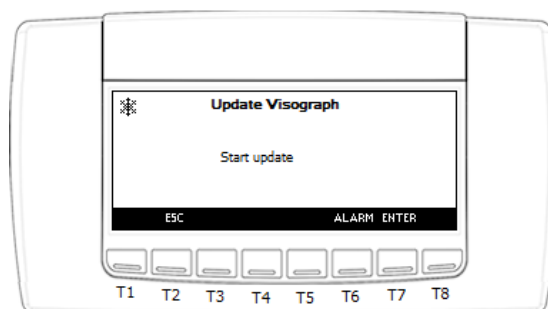

- Language selection:

In this subsection it is possible to select the language. Available tongues are: Italian, English, French, Spanish and German.

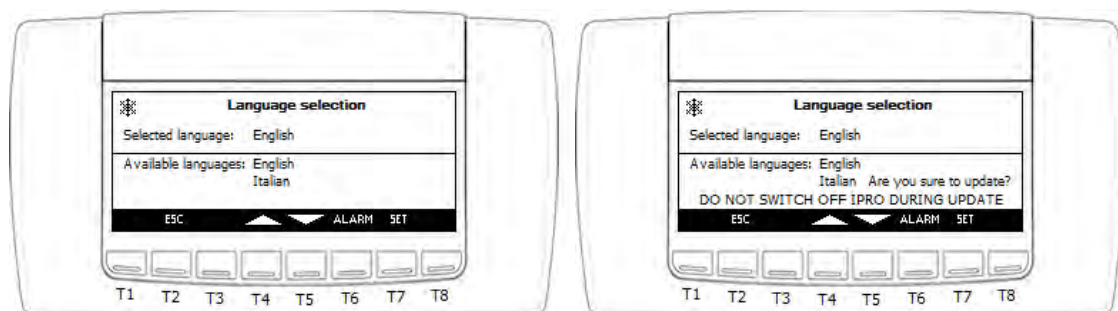

Warning: Do not remove power supply to the microprocessor and do not disconnect the keypad during the updating.

- System Informations:

In this subsection it is possible to edit the IP address and the MODbus® address. The modification will be actual at next reboot of the controller.

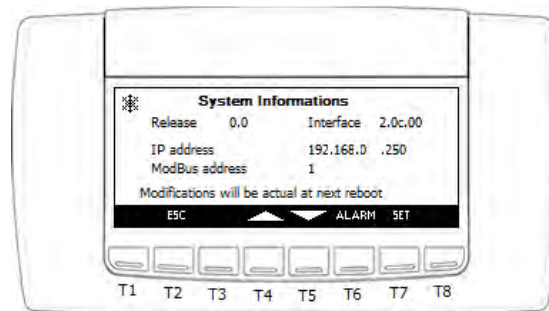



4. Led Operator Interface

Small chillers and heat pumps, equipped with the advanced controller, have the small size one that has a LED built-in keyboard, through which it is possible to monitor and to modify the status and settings of the unit.



4.1. Main Screen

Info reported on the main screen is related to the "Unit status".

Pressing key  or  it is possible to see the value of the configured probes.

First line displays probe value, the second one displays probe name

In case an alarm occur, its code flashes on the second line.























The available probes are:

Display as	AI description
EIn	Evaporator common input NTC temperature probe
Out1	Evaporator 1 output NTC temperature probe
Out2	Evaporator 2 output NTC temperature probe
EOut	Evaporator common outlet NTC temperature probe

CIn	Condenser hot water common input NTC temperature probe
CIn1	Circuit 1 condenser hot water input NTC temperature probe
CIn2	Circuit 2 condenser hot water input NTC temperature probe
COu1	Circuit 1 condenser hot water output NTC temperature probe
COu2	Circuit 2 condenser hot water output NTC temperature probe
COut	Condenser hot water common output NTC temperature probe
FCIn	System water inlet NTC temperature probe (free-cooling)
Et	External air temperature
SAn1	Domestic water temperature regulation NTC temperature probe (num. 1)
SAn2	Domestic water temperature safety NTC temperature probe (num. 2)
ROut	Heat recovery outlet NTC temperature probe
RIn	Heat recovery inlet NTC temperature probe
dSet	Dynamic set-point 4÷20 mA probe
CdP1	Circuit 1 condensation probe (pressure 4÷20 mA / ratiometric 0÷ 5Volt)
CdP2	Circuit 2 condensation probe (pressure 4÷20 mA / ratiometric 0÷ 5Volt)
LP1	Circuit 1 evaporation pressure probe (pressure 4÷20 mA / ratiometric 0÷ 5Volt)
LP2	Circuit 2 evaporation pressure probe (pressure 4÷20 mA / ratiometric 0÷ 5Volt)
uSt1	Auxiliary output 1 NTC temperature probe
uSt2	Auxiliary output 2 NTC temperature probe
uSP1	Circuit 1 auxiliary output pressure probe (pressure 4÷20 mA / ratiometric 0÷ 5Volt)
uSP2	Circuit 2 auxiliary output pressure probe (pressure 4÷20 mA / ratiometric 0÷ 5Volt)

Meaning of each LED:

-  to indicate that the measurement unit of displayed probe/parameter is in °C.
-  to indicate that the measurement unit of displayed probe/parameter is in °F.
-  to indicate that RTC is displaying now.
-  to indicate that the measurement unit of displayed probe/parameter is in bar.
-  to indicate the measurement unit of displayed probe/parameter is in PSI.
- ...  to indicate if compressors from 1 to 6 are working.







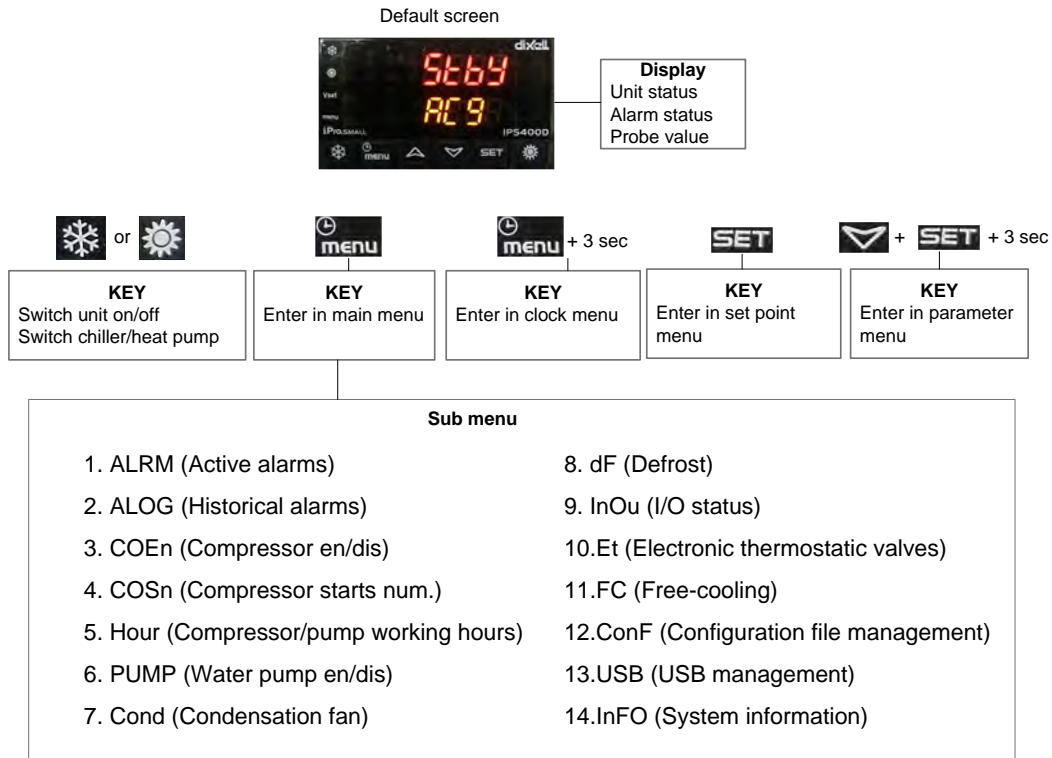

-  on to indicate that the defrost cycle is in progress, flashing during the countdown.
-  to indicate that the condenser fans are working.
-  to indicate that the water pump/supply fan is working.
-  to indicate that the anti-freeze/auxiliary heaters are active.
-  to indicate that the auxiliary outputs are active.
-  flashing to indicate that an alarm is active.
-  to indicate that the probe display now is belongs to circuit 1.
-  to indicate that the probe display now is belongs to circuit 2.
-  flashing to indicate that the AEFL or ACFL or AHFL or APFL alarm is active
-  to indicate that in heat pump mode.
-  to indicate that in chiller mode.
-  to indicate that the unit is working within the energy saving period or that the dynamic set-point is active.
-  to indicate that menu screen is displaying.

4.2. Keyboard structure

Information on keypad is divided in different menus and sub-sections. The most researched have a direct link with the main screen by using quick dial keys; the most specific info referred to the status of the components or to the status of functions, instead, is reported in specific menus into “**SERVICE**” branch.



KEYS FUNCTIONS

-  Press this key to switch on/off the unit to work in heat pump mode.
-  Press to enter in main menu screen. Keep press for 3 seconds to adjust clock.
-  Press to switch probe being shown
-  Press to switch probe being shown
-  Press to check set point
-  Press this key to switch on/off the unit to work in chiller mode.
-  +  Press these 2 keys together for 3 seconds to check parameters.

4.3. Set Point Section



In the Set Point section it is possible to edit the water set-points.

This tab has a direct link with the main screen through the **SET** button.



First line displays set point value, the second one displays the type:

- **SEtC** -> set point in chiller mode (**ST01**)
- **SEtH** -> set point in heat pump mode (**ST04**)
- **SEtd** -> real set point when dynamic set point is active
- **SEtS** -> real set point when energy saving is active
- **SEtr** -> real set point when both dynamic set point and energy saving are active

If the unit is turned off, by keyboard or remotely, scrolling up or down using  or  it is possible to see both chiller and heat pump set points. When the unit is turned on, only the one corresponding to the current operating mode and the real set, if energy saving or dynamic set point are active, are visible.

HOW TO EDIT SET POINTS

To modify the set point, select the desired one using **UP** and **DOWN** buttons and press **SET** for 3 seconds to enable the editing. The element starts to flash.

Increase or decrease the value using the **UP** and **DOWN** keys and press again **SET** to confirm the new value.

Press key **SET** to escape and jump back to the main screen.

4.4. Service branch

It is possible to enter in the “SERVICE” branch pressing the **MENU** key in the default screen.



With **UP** and **DOWN** buttons it is possible to scroll on all available sub-menus and pressing **SET** to enter in the selected one.

Sub-menu name	Visible condition	Description
ALRM	Always visible	Active alarms
ALOG	Always visible	Historical alarms
COEn	Always visible	Compressor enable/disable
COSn	Always visible	Compressor starts number
Hour	Always visible	Compressor/pump working hours
PUMP	No motor-condensing unit	Water pump enable/disable
Cond	Air-cooled unit	Condensation fan
dF	Unit in heating mode	Defrost
InOu	Always visible	I/O status
Et	Integrated ExV driver is present	Electronic expansion valves
tEVI	TEVI Vapor injection driver is present	TEVI Vapor injection control
ConF	Always visible	Configuration file management
USB	Always visible	USB management
InFO	Always visible	System information

The **Menu** button has the escape function too.

4.4.1. Parameters Programming

Pressing keys  + **SET** together for 3 seconds in the default screen it is possible to enter into parameters programming screen.



In this screen, it is possible to select user level.

There are 3 levels, the first one for end user is without password.

Label	Meaning
ST	Displays temperature control parameters
DP	Displays variables to be shown on main screen of the keyboard
CF	Displays configuration parameters
SP	Displays parameters for machine set up
Sd	Displays dynamic set-point parameters
ES	Displays energy saving and automatic timed switch-on/off parameters
AH	Displays auxiliary heating parameters
CO	Displays compressor parameters and timings
SL	Displays stepless compressor parameters
PA	Displays evaporator/condenser water pump parameters
Pd	Displays pump down function parameters
Un	Displays unloading function parameters
FA	Displays ventilation parameters
Ar	Displays anti-freeze heaters parameters
dF	Displays defrost parameters
rC	Displays heat recovery parameters
FS	Displays production of domestic hot water parameters
FC	Displays free-cooling function parameters
US	Displays auxiliary output parameters
AL	Displays alarm parameters
Et	Displays parameters for the management of the electronic expansion valve and TEVI control

IO	Displays inputs/outputs configuration parameters
CA	Displays analog input calibration parameters
RA	Displays analog input range parameters

HOW TO INPUT PASSWORD



To input the password, press **SET** to enable the editing.

The element “0” starts to flash. Insert the value using the **UP** and **DOWN** keys and press again **SET** to confirm the new value.

Key  or  have fast increasing/decreasing function with 100 every time.



If inputted password is not correct, it will change back to “0” otherwise it jumps to the screen with parameter groups.

Press key **MENU** to escape and jump back into previous screen.

HOW TO EDIT PARAMETERS

Select the desired group using  or  buttons and press **SET** to enter.

In this group the name of the parameter will be displayed in the second line and its value in the first line.

Select the desired group using  or  buttons and press **SET** for 3 seconds to enable the editing.

The element starts to flash. Insert the value using the **UP** and **DOWN** keys and press again **SET** to confirm the new value.

The parameter group **IO** is divided into 4 sub-groups: **Pb**, **DI**, **rL** and **AO**.

Some parameters could be visible but not editable for a specific level.

If the parameter is not editable, “.” LED in the second line will be lightened as an indication as picture below:



Press key **MENU** to escape and jump back into previous screen.

4.4.2. Alarm Section

When an alarm occurs, the display shows the flashing led . Entering in the **ALRM** sub menu of “**SERVICE**” branch it is possible to read which specific code is active and reset it, if possible.



In this submenu in the second lines displayed the alarm code, on the first one the status:

- **no**: still active, not resettable
- **rSt**: resettable
- **PASS**: resettable with password

If the alarm is not still active, to reset it is necessary to press key **SET**. If it requires a password, its input screen will appear.



HOW TO INPUT PASSWORD

To input the password, press **SET** for 3 seconds to enable the editing.

The element “0” starts to flash. Insert the value using the **UP** and **DOWN** keys and press again **SET** to confirm the new value.

Key  or  have fast increasing/decreasing function with 100 every time.

If inputted password is not correct, it will change back to “0” otherwise it jumps to the other active alarms.

Press key **MENU** to escape and jump back into previous screen.

ALARM CODES TAB

Code Alarm	Alarm description
AP1	PB1 probe
AP2	PB2 probe
AP3	PB3 probe
AP4	PB4 probe
AP5	PB5 probe
AP6	PB6 probe
AP11	Expansion1 probe1
AP12	Expansion1 probe2
AP13	Expansion1 probe3
AP14	Expansion1 probe4
AP15	Expansion1 probe5
AP16	Expansion1 probe6
AP17	Expansion1 probe7
AP39	XEV20D 1 probe1
AP40	XEV20D 1 probe2
AP41	XEV20D 1 probe3
AP42	XEV20D 1 probe4
AP43	XEV20D 2 probe1
AP44	XEV20D 2 probe2
AP45	XEV20D 2 probe3
AP46	XEV20D 2 probe4
AP55	TEVI 1 probe 1
AP56	TEVI 1 probe 2
AP57	TEVI 1 probe 3
AP58	TEVI 1 probe 4
AEFL	Evaporator flow switch alarm
ACFL	Condenser flow switch alarm
AtSF	Supply fan circuit breaker alarm
AEUn	Evaporator unloading signalling
AtE1	Evaporator n° 1 water pump overload
AtE2	Support evaporator n° 2 water pump overload
AtC1	Condenser n° 1 water pump overload
AtC2	Support condenser n° 2 water pump overload
AEP1	Evaporator n° 1 water pump maintenance
AEP2	Support evaporator n° 2 water pump maintenance
ACP1	Condenser n° 1 water pump maintenance
ACP2	Support condenser n° 2 water pump maintenance
AHFL	Domestic hot water pump flow switch alarm
ARFL	Recovery flow switch alarm
AEht	Evaporator water inlet high temperature alarm
AET1	XEV20D 1 not connected alarm
AET2	XEV20D 2 not connected alarm
AEJ1	TEVI 1 not connected alarm
AEM1	IPROEX60D 1 not connected alarm
AFFC	Anti-freeze alarm in free-cooling
AtR1	Recovery n° 1 water pump overload
AtR2	Support recovery n° 2 water pump overload
AfnA	Function not available alarm
ASPh	Phases sequence alarm
ALc1	Generic alarm 1
ARP1	Recovery n° 1 water pump maintenance
ARP2	Recovery n° 2 water pump maintenance
ACFx	Configuration alarm n° "x"
AC1n	Configuration alarm n° 1"x"

Code Alarm	Alarm description
b(n)HP	Circuit high pressure switch (n)
b(n)LP	Circuit low pressure switch (n)
b(n)AC	Anti-freeze in cooling circuit (n)
b(n)AH	Anti-freeze in heating circuit (n)
b(n)A	Source Anti-freeze alarm in circuit (n)
b(n)hP	Condensing high pressure transducer circuit (n)
b(n)IP	Circuit (n) low evaporating pressure
b(n)tF	Circuit fan overload alarm (n)
b(n)dF	Circuit defrost alarm signal(n)
b(n)Cu	Unloading signal due to circuit (n) high condensing temp. / press.
b(n)Eu	Unloading signal due to circuit (n) evaporating low temp.
b(n)rC	Circuit (n) heat recovery disabling signal
b(n)PH	Circuit pump down stopping alarm (n)
b(n)PL	Circuit pump down start-up alarm (n)

Code Alarm	Alarm description
C(n)HP	Compressor (n) high pressure switch
C(n)oP	Compressor (n) oil pressure switch/oil float
C(n)tr	Compressor overload(n)
C(n)dt	Compressor high discharge temperature
C(n)Mn	Compressor maintenance (n)

4.4.3. Alarm History Section



All alarms are memorized and displayed in the “**ALOG**” sub-menu together to the date and the status of the unit when the event occurred.



In the first screen the alarm code is displayed together to its event number in an hour. Pressing **SET** it is possible to see more detailed info including the status of the unit and the date when the alarm occurred.



HOW TO DELETE ALARMS LOG

To clear the logs of the alarms scroll on using  or  till find “**PASS**” in first line and “**Arst**” in second line.

Press **SET** for 3 seconds to enable the editing.

The element “**0**” starts to flash. Insert the value using the **UP** and **DOWN** keys and press again **SET** to confirm the new value.

Key  or  have fast increasing/decreasing function with 100 every time.

If inputted password is not correct, it will change back to “**0**” otherwise alarms log is cancelled.



Press key **MENU** to escape and jump back into previous screen.

4.4.4. Compressors Menu

In “COEn” submenu it is possible to enable and disable the compressors for maintenance. Info about working hour and the number of the start-up is reported into two different submenus.



On the second line is reported the compressor index and on first is reported its current status

Press key  or  to scan all configured compressors and press **SET** button for 3 seconds to modify the en/dis status of the selected one.



Press key **MENU** to escape and jump back into previous screen.

4.4.5. Compressor Starts Number Menu

In “COSn” submenu it is possible to view and reset the number of the start-up of each configured compressor.



On the second line is reported the compressor index and on first is reported its start-up number. The unit of measurement is x10Times



Press key  or  to scan all configured compressors and press **SET** button for 3 seconds to reset the start-up numbers of the selected one, inserting the correct password.

4.4.6. Water Pump Menu

In “PUMP” submenu it is possible to enable and disable the water pumps for maintenance. Info about working hour is reported into a different submenu. It is not visible on motor-condensing units.



On the second line is reported the pump index and on first is reported its current status

Press key  or  to scan all configured water pumps and press **SET** button for 3 seconds to modify the en/dis status of the selected one.



Press key **MENU** to escape and jump back into previous screen.

4.4.7. Compressors & Pumps Working Hour Menu

In “HOUR” submenu it is possible to view and reset the working hours of each compressor and water pump.



On the second line is reported the compressor or pump index and on first is reported the value of its working hour.

Press key  or  to scan all configured water pumps and press **SET** button for 3 seconds to reset it, inserting the correct password.

4.4.8. Condensing Fan Menu

In “COND” submenu it is possible to see the working status of the condensing / evaporating fans.

It is visible only on air-cooled version units.



On the second line is reported the fan circuit index and on first is reported its current output value:

- 0-100 : in case of continuous fan control
- 0-4: in case of step control

Press key **MENU** to escape and jump back into previous screen.

4.4.9. Defrost Menu

In “dF” submenu it is possible to see the working status of the defrost cycle.

It is visible only on heat pumps during their operation in heating mode.



On the first line is reported the circuit index and on second is displayed the countdown before that a defrost cycle starts.

Pressing key **SET** for 3 seconds it is possible to force a defrost cycle manually.

Press key **MENU** to escape and jump back into previous screen.



4.4.10. Input / Output Menu

In “InOu” submenu it is possible to see the status of the input and output of the controller.



The I/O list is divided in 4 groups:

- **Pb**: analog input
- **di**: digital input
- **rL**: digital output
- **out**: analog output

Press key  or  to scan all type and press **SET** button to enter.

Using the **UP** and **DOWN** it is possible to scroll on the list.

PROBES (Pb)



DIGITAL INPUT (di)



RELAY (rL)



ANALOG OUTPUT (out)



4.4.11. **Electronic Expansion Valve Menu**

In “Et” submenu it is possible to see the working status of the expansion valves.

This menu is available only if the ExV driver is integrated with the main microprocessor



On the first line is reported the value and on second is displayed the info description:

- **Open:** valve opening percentage
- **SH:** super heat
- **Tasp:** suction temperature
- **Pasp:** suction pressure

If 2 circuits are configured, to switch to another expansion valve it is necessary to press key **SET**.

Press key **MENU** to escape and jump back into previous screen.

4.4.12. **TEVI control Menu**

In “tEVI” submenu it is possible to see the working status of the expansion valve/s for vapor injection control.

This menu is available only if the TEVI driver is integrated with the main microprocessor



On the first line is reported the value and on second is displayed the info description:

- **Opn1:** valve opening percentage valve 1
- **Opn2:** valve opening percentage valve 2
- **SH:** super heat vapor injection
- **Plnj:** pressure vapor injection
- **TSat:** saturated temperature vapor injection
- **tInJ:** temperature vapor injection

- **tSC1**: discharge temperature compressor 1
- **tSC2**: discharge temperature compressor 2

4.4.13. Configuration File Management Menu



In “**ConF**” submenu it is possible to load the parameters from configuration files.



In the memory of the microprocessor are saved 2 files parameters map. One called “**actual**” that represents the **latest saved copy of the parameters map** and another one called “**default**” that represents the **factory settings to erase all preconfigured function**.

Within this subsection it is possible to load and to set as parameters map the last saved copy or the “**default**” one.

Using the 3rd command “**Save as default parameters**” it is possible to **overwrite** the values contained into the “**default**” copy with those contained in latest saved copy or “**actual**”.

Press key  or  to select the desired command and press **SET** for 3 seconds to confirm.

Once confirmed, on the second line is reported the status of the operation:

- **In Progress**: loading in progress.
- **done**: loading done
- **FAIL**: loading failed

Press key **MENU** to escape and jump back into previous screen.

4.4.14. Log File Management Menu



In “USB” submenu it is possible to download the log files from the controller into an USB mass storage.

If no USB key is detected, the following message will display:



Otherwise on first line is reported the label **SEND** and in the second one the file to download:

- **Unit LoG**: only the Unit log file
- **ALArM LoG**: only the Alarms log file
- **Et LoG**: only the Xev log file:
- **ALL**: All the logs above + the Access Log file

Press key  or  to select the desired command and press **SET** for 3 seconds to confirm.

Once confirmed, on the second line is reported the status of the operation:

- **In Progress**
- **done**
- **Error**

Press key **MENU** to escape and jump back into previous screen.

4.4.15. System Information Menu

In “InFO” submenu it is possible to see some system information.

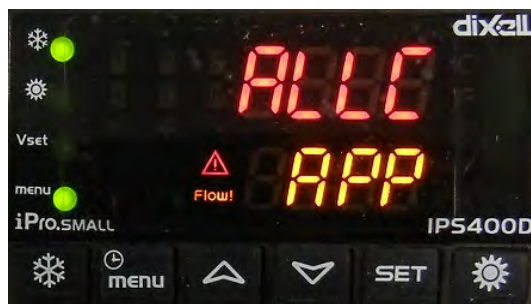

The available info is:

- **APP**: software application name
- **Adr**: Modbus address
- **IP**: IP address

Press key  or  to scroll on the information.

Press key **MENU** to escape and jump back into previous screen.

5. Unit Activation

At the unit startup, the main screen of units will show:

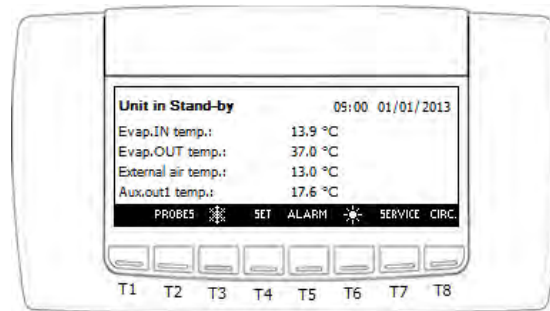

It is possible to activate the unit using the keyboard:

- In “Chilled water production mode” pressing the sun button .

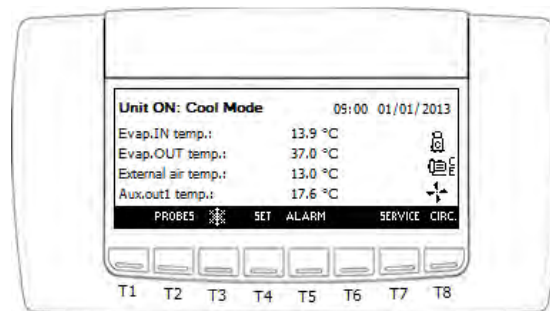

- In “Hot water production mode” pressing the snow button .

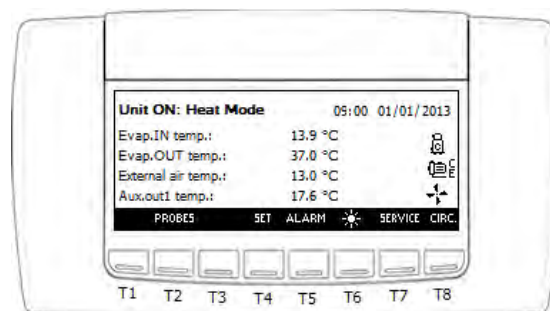

6. Temperature Control

The units provides different regulation modes.

By modifying the parameters **ST9** and **ST10** the probes can be defined on which the temperature control of the unit, either in cooling mode or in heating mode, is based on.

By modifying the parameters **ST11** the control mode between the followings can be selected:

- **Proportional step regulation:** suggested with temperature control based on the return to the unit
- **Neutral zone:** strongly recommended with temperature control based on the delivery.

Par.	Description	Min	Max	U.M.
ST9	Chilled water temperature control probe	0	7	
ST10	Hot water temperature control probe	0	3	
ST11	Defines the type of temperature control	0	4	

In both case before to activate or deactivate a compressor / partial step, the microprocessor will respect the parameters in the tab below in order to avoid compressors short cycling.

Par.	Description	Min	Max	U.M.
CO1	Compressor minimum ON time	1	250	10sec
CO2	Compressor minimum OFF time	0	250	10sec
CO3	Minimum time between one activation and another on the same compressor	0	250	10sec
CO4	Activation delay between 2 compressors/steps	1	250	sec
CO5	Deactivation delay between 2 compressors/steps	1	250	sec

6.1. Proportional Step Regulation

The regulation band will be divided in a number of intervals (steps) depending on the total number of the compressors in the unit and on their possible partial steps. This implies that for each step an activation threshold and a deactivation one will be defined.

When the value measured by the selected temperature control probe cross these threshold, the activation / deactivation request of one or more compressors/partial steps occurs.

Cooling

The following equations are applied for the calculation of the different activation thresholds:

Total number of regulation steps = Number of compressors + (Number of compressors * Number of partial steps / compressor)

Width of proportional step = Proportional regulation band [**ST7**] / Total number of regulation steps

Step activation threshold = regulation set point [**ST1**] + (Width of proportional step* Step's progressive [1,2,3, etc.]).

Par.	Description	Min	Max	U.M.
ST1	Chiller set point	ST2	ST3	°C
ST2	Minimum chiller set point	-50.0	ST3	°C
ST3	Maximum chiller set point	ST2	110.0	°C
ST7	Intervention band regulation steps in chiller mode	0.1	25.0	°C

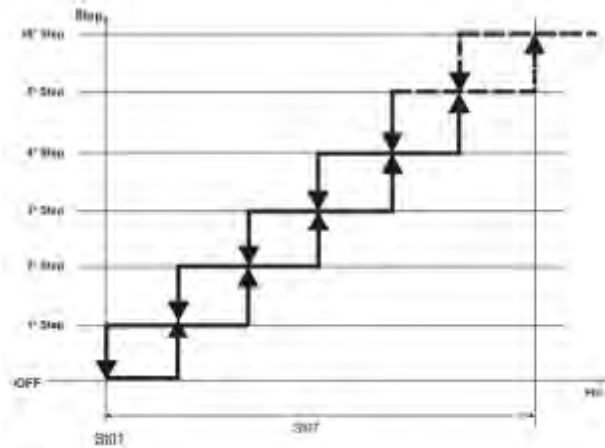

Heating

The following equations are applied for the calculation of the different activation thresholds:

Total number of regulation steps = Number of compressors + (Number of compressors * Number of partial steps / compressor)

Width of proportional step = Proportional regulation band [ST8] / Total number of regulation steps

Step activation threshold = Regulation set point [ST4] - (Width of proportional step * Step's progressive [1,2,3, etc.]).

Par.	Description	Min	Max	U.M.
ST4	Heat pump set point	ST5	ST6	°C
ST5	Heat pump minimum set point	-50.0	ST6	°C
ST6	Heat pump maximum set point	ST5	110.0	°C
ST8	Intervention band regulation steps in heat pump mode	0.1	25.0	°C

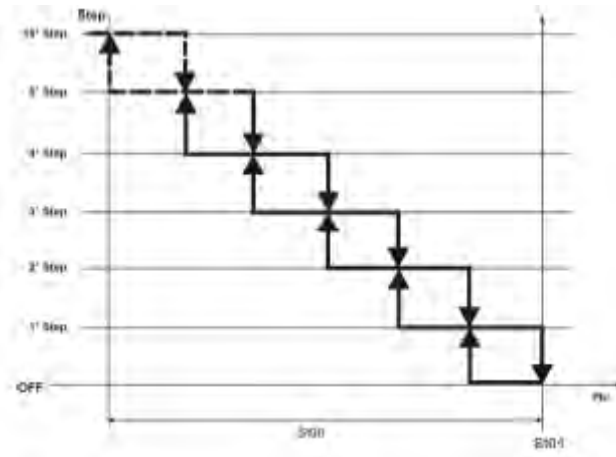

6.2. Neutral Zone

The loading, unloading and constant areas are defined by means of the following parameters:

Cooling

Par.	Description	Min	Max	U.M.
ST1	Chiller set point	ST2	ST3	°C
ST2	Minimum chiller set point	-50.0	ST3	°C
ST3	Maximum chiller set point	ST2	110.0	°C
ST7	Intervention band regulation steps in chiller mode	0.1	25.0	°C
ST29	Activation offset 1 st step with neutral zone regulation	0.0	25.0	°C
ST30	Activation delay 1 st step with neutral zone regulation	0	250	sec
ST31	Deactivation offset last step with neutral zone regulation	0.0	25.0	°C
ST32	Deactivation delay last step with neutral zone regulation	0	250	sec

Temperature values included between ST1 and ST1+ST7 will not cause any compressors activation / deactivation. This is reason why this interval is called Neutral Zone.

Temperature values greater or equal to ST1+ST7+ST29, which insist for a continuous time greater or equal to ST30, will cause the start-up request of the first power step of the unit.

The remaining steps will be activated one by one every CO4 seconds, if the probe selected for the control detects temperature values greater or equal to ST1+ST7.

The deactivation of the first steps will occur based on temperature values lower than ST1 one by one every CO5 seconds until only one is active and it will be deactivated if the temperature stays below ST1-ST31 for a time greater than ST32 seconds.

A further safety threshold (calculated according to the other parameters values) is available. Below this threshold the unconditioned deactivation of all the power steps will occur in order to avoid an excessive cooling power production.

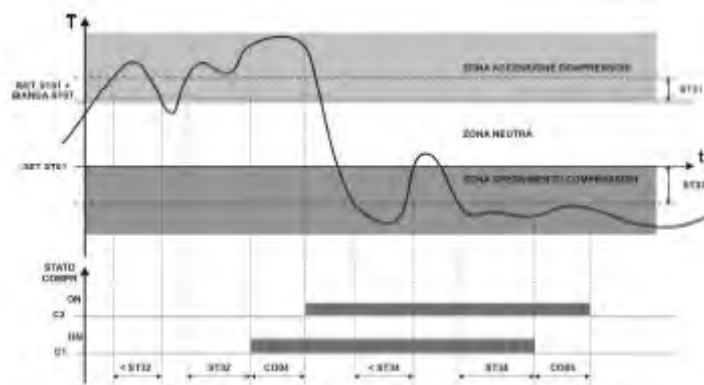

Heating

Par.	Description	Min	Max	U.M.
ST4	Heat pump set point	ST5	ST6	°C
ST5	Heat pump minimum set point	-50.0	ST6	°C
ST6	Heat pump maximum set point	ST5	110.0	°C
ST8	Intervention band regulation steps in heat pump mode	0.1	25.0	°C
ST29	Activation offset 1 st step with neutral zone regulation	0.0	25.0	°C
ST30	Activation delay 1 st step with neutral zone regulation	0	250	sec
ST31	Deactivation offset last step with neutral zone regulation	0.0	25.0	°C
ST32	Deactivation delay last step with neutral zone regulation	0	250	sec

Temperature values included between ST4 and ST4-ST8 will not cause any compressors activation / deactivation. This is reason why this interval is called Neutral Zone.

Temperature values lower than or equal to ST4-ST8-ST29, which insist for a continuous time greater or equal to ST30, will cause the switch-on of the first power step of the system.

The remaining steps will be activated one by one every CO4 seconds, if the probe selected for the control detects temperature values lower than or equal to ST4-ST8.

The deactivation of the first steps will occur based on temperature values greater than ST4 one by one every CO5 seconds until only one is active and it will be deactivated if the temperature stays over ST4+ST31 for a time greater than ST32 seconds.

A further safety threshold (calculated according the other parameters values) is available. Over that threshold the unconditioned deactivation of all the power steps will occur in order to avoid an excessive heating power production.

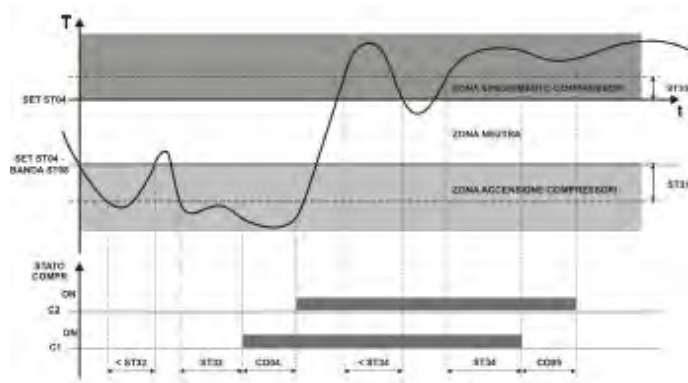

6.3. Stepless Control for Screw Units

The loading, unloading and constant areas are defined by means of the following parameters:

Cooling

Par.	Description	Min	Max	U.M.
ST1	Chiller set point	ST2	ST3	°C
ST2	Minimum chiller set point	-50.0	ST3	°C
ST3	Maximum chiller set point	ST2	110.0	°C
ST7	Intervention band regulation steps in chiller mode	0.1	25.0	°C
ST29	Activation offset 1 st step with neutral zone regulation	0.0	25.0	°C
ST30	Activation delay 1 st step with neutral zone regulation	0	250	sec
ST31	Deactivation offset last step with neutral zone regulation	0.0	25.0	°C
ST32	Deactivation delay last step with neutral zone regulation	0	250	sec
SL9	Neutral Zone in cooling mode	0.1	25.0	°C

Temperature values included between $ST1 - SL9/2$ and $ST1 + SL9/2$ will not cause any compressors activation / deactivation or loading / unloading of compressor capacity. This is reason why this interval is called Neutral Zone.

Temperature values greater or equal to $ST1 + ST7/2 + ST29$, which insist for a continuous time greater or equal to $ST30$, will cause the start-up request of the first power step of the unit.

The remaining compressors will be activated one by one, according to the set selection criteria, every $CO4$ seconds, if the probe selected for the control detects temperature values greater or equal to $ST1 + ST7/2$.

The loading and unloading area for compressors in operation are defined by temperatures between $ST1 + SL9/2$ and $ST1 + ST7/2$ for the loading and $ST1 - SL9/2$ and $ST1 - ST7/2$ for the unloading.

The deactivation of the first compressor will occur based on temperature values lower than $ST1 - ST7/2$ one by one every $CO5$ seconds until only one is active and it will be deactivated if the temperature stays below $ST1 - ST7/2 - ST31$ for a time greater than $ST32$ seconds.

Compressors will be not deactivated until their capacity arrives to the minimum value.

A further safety threshold (calculated according to the other parameters values) is available. Below this threshold the unconditioned deactivation of all the power steps will occur in order to avoid an excessive cooling power production.

Heating

Par.	Description	Min	Max	U.M.
ST4	Heat pump set point	ST5	ST6	°C
ST5	Heat pump minimum set point	-50.0	ST6	°C
ST6	Heat pump maximum set point	ST5	110.0	°C
ST8	Intervention band regulation steps in heat pump mode	0.1	25.0	°C
ST29	Activation offset 1 st step with neutral zone regulation	0.0	25.0	°C
ST30	Activation delay 1 st step with neutral zone regulation	0	250	sec
ST31	Deactivation offset last step with neutral zone regulation	0.0	25.0	°C
ST32	Deactivation delay last step with neutral zone regulation	0	250	sec
SL10	Neutral Zone in heating mode	0.1	25.0	°C

Temperature values included between $ST4 - SL10/2$ and $ST4 + SL10/2$ will not cause any compressors activation / deactivation or loading / unloading of compressor capacity. This is reason why this interval is called Neutral Zone.

Temperature values lower or equal to $ST4 - ST8/2 - ST29$, which insist for a continuous time greater or equal to $ST30$, will cause the start-up request of the first power step of the unit.

The remaining compressors will be activated one by one, according to the set selection criteria, every $CO4$ seconds, if the probe selected for the control detects temperature values lower or equal to $ST4 - ST8/2$.

The loading and unloading area for compressors in operation are defined by temperatures between $ST4 - SL10/2$ and $ST4 - ST8/2$ for the loading and $ST4 + SL10/2$ and $ST4 + ST8/2$ for the unloading.

The deactivation of the first compressor will occur based on temperature values lower than $ST4 + ST8/2$ one by one every $CO5$ seconds until only one is active and it will be deactivated if the temperature stays above $ST4 + ST8/2 + ST31$ for a time greater than $ST32$ seconds.

Compressors will be not deactivated until their capacity arrives to the minimum value.

A further safety threshold (calculated according to the other parameters values) is available. Above this threshold the unconditioned deactivation of all the power steps will occur in order to avoid an excessive cooling power production.

6.4. Partial Heat Recovery

The temperature control of the partial recovery user is present only if it was requested it is a single proportional step type based on return temperature.

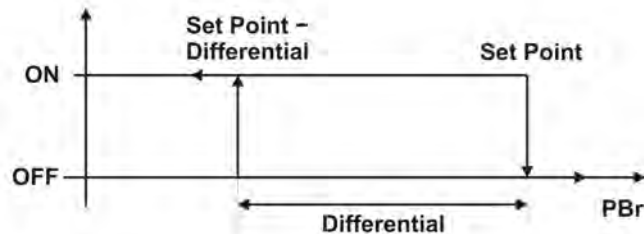

Par.	Description	Min	Max	U.M.
RC13	Heat Recovery water set point	RC11	RC12	°C
RC14	Heat Recovery water regulation differential	0.1	25.0	°C
RC11	Minimum heat recovery water set point value	-50.0	RC12	°C
RC12	Maximum heat recovery water set point value	RC11	110.0	°C

The desuperheater is active if the request is ON while there is at least one compressor in operation and none refrigerant circuit is performing a defrost cycle.

It is possible to enable/disable this function by keyboard as reported on chapter 3.4.9.

6.5. Total Heat Recovery

The temperature control of the total recovery user, if present, is a proportional step type based on return temperature.

The number of the available steps is equal to the number of the refrigerant circuit presents.

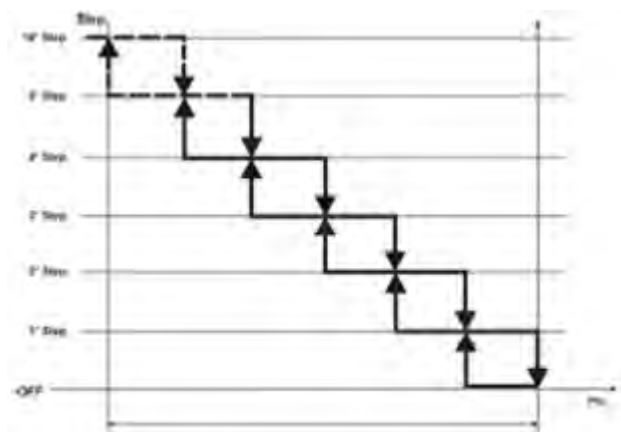

Par.	Description	Min	Max	U.M.
RC13	Heat Recovery water set point	RC11	RC12	°C
RC14	Heat Recovery water regulation differential	0.1	25.0	°C
RC11	Minimum heat recovery water set point value	-50.0	RC12	°C
RC12	Maximum heat recovery water set point value	RC11	110.0	°C

The heat recovery, in this case, is active if the request is ON while there is at least one requested compressor to satisfy the main user.

This function “enables” the amount of circuits to operate in heat recovery, according to the request, but it is the chilled water production to determine the number of steps that have to operate.

It is possible to enable/disable this function by keyboard as reported on chapter 3.4.9.

6.6. Domestic hot water control by 3way valve

The temperature control of the domestic hot water user, if present, is a proportional step type based on measured temperature by the sensor to install in sanitary water tank.

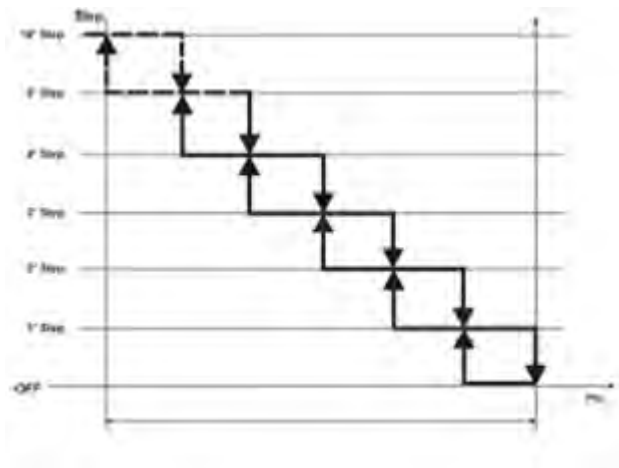

Par.	Description	Min	Max	U.M.
FS2	Space heating Priority Vs Dom. hot water Priority	0	1	
FS3	Domestic water set point	FS5	FS6	°C
FS4	Domestic water regulation differential	0.1	25.0	°C
FS5	Minimum domestic water set point value	-50.0	FS6	°C
FS6	Maximum domestic water set point value	FS5	110.0	°C

The number of the available steps depends on the total number of the compressors in the unit and on their possible partial steps.

Factory Priority is set on domestic hot water production.

The domestic hot water is active if the request is ON and none refrigerant circuit is performing a defrost cycle.

It is possible to enable/disable this function by keyboard as reported on chapter 3.4.12.

7. Water Pumps Management

The management of pump groups is related to the value of the parameter Pump Operation Mode:

Par.	Description	Min	Max	Note
PA1	Evaporator pump operation mode	0	2	Chilled water side
PA17	Source pump operation mode	0	2	Source side on water cooled units
PA31	Recovery pump operation mode	0	2	Hot water side

- **0: Not Present**
- **1: Continuously** – The pump is always active when the unit is active not depending on the operation of the compressors.
- **2: On demand** – The pump is active just when a capacity step is required.

The controller ensures that times and delays between switch-on/switch-off of the compressors and pumps are respected.

In case of detection of freeze alarm condition, the microprocessor will force to switch on the pumps.

Evaporator Pump

Par.	Description	Min	Max	U.M.
PA2	First Compressor ON delay from pump starting-up	0	250	10sec
PA3	Evaporator water pump OFF delay from last compressor stops	0	250	10sec
PA4	Deactivation Pump Delay from unit turning Off	0	250	10sec

Condenser Pump / Source water side on water cooled units

Par.	Description	Min	Max	U.M.
PA18	First Compressor ON delay from starting-up	0	250	10sec
PA19	Condenser pump OFF delay from last compressor stops	0	250	10sec
PA20	Deactivation Pump Delay from unit turning Off	0	250	10sec

Heat Recovery Pump

Par.	Description	Min	Max	U.M.
PA32	First Compressor ON delay from pump starting-up	0	250	10sec
PA33	Recovery water pump OFF delay from last compressor stops	0	250	10sec
PA34	Deactivation Pump Delay from unit turning Off	0	250	10sec

7.1. Variable Speed Water Pumps Management

If the unit is equipped with variable speed water pumps, the controller will drive them proportionally to the produced capacity.

Evaporator Pump

Par.	Description	Min	Max	U.M.
US21	Minimum value for 0-10V evap. analogue output	0	US22	%
US22	Maximum value for 0-10V evap. analogue output	US21	100	%

Heat Recovery Pump

Par.	Description	Min	Max	U.M.
US28	Minimum value for 0-10V rec. analogue output	0	US29	%
US29	Maximum value for 0-10V rec. analogue output	US28	100	%

Condenser Pump / Source water side on water cooled units

Par.	Description	Min	Max	U.M.
US35	Minimum value for 0-10V source analogue output	0	US35	%
US36	Maximum value for 0-10V source analogue output	US36	100	%

In case of water-cooled unit, the variable speed source pump will be driven to keep the working point of the unit inside its envelope.

7.2. Water Pumps Rotation

The water pumps rotation is enabled only if 2 pumps are configured.

The controller will perform the pump rotation immediately in case of Overload alarm on the running pump.

In normal operation the controller will perform the rotation according the selected mode:

- **manual:** The running pump is related to the selected pump:
 - pump 1 active
 - pump 2 active
- **automatic:** the controller will rotate the 2 pumps according:
 - Start-up: each water pump start-up the controller will not activate the same of last time.
 - Working hours number achievement: the change-over between the 2 pumps is carried out only when the active pump achieves the pre-defined cumulative number of working hours
 - Working hour achievement & start-up: in addition to previous mode, in this one the controller will change the pump at each start-up too.

Evaporator Pump

Par.	Description	Min	Max	U.M.
PA5	Pump Activation and Rotation		4	
PA6	Manual Pump Inversion		1	
PA7	No. of hours for forced evaporator pump rotation	0	999	10ore
PA8	Simultaneous pump running time after forced pump rotation	0	250	sec

Condenser Pump / Source water side on water cooled units

Par.	Description	Min	Max	U.M.
PA21	Pump Activation and Rotation		4	
PA22	Manual Pump Inversion		1	
PA23	No. of hours for forced condenser pump rotation	0	999	10ore
PA24	Simultaneous pump running time after forced pump rotation	0	250	sec

Heat Recovery Pump

Par.	Description	Min	Max	U.M.
PA35	Pump Activation and Rotation		4	
PA36	Manual Pump Inversion		1	
PA37	No. of hours for forced evaporator pump rotation	0	999	10ore
PA38	Simultaneous pump running time after forced pump rotation	0	250	sec

8. Low Water Flow Alarm Management

A differential pressure switch is installed on the exchangers of the unit.

It is mandatory to install an additional paddle flow switch (one per user) on pipes close to the unit and wires its digital contact in series to the one on board.

In the control loop there is a delay to bypass the alarm at pump start-up in order to wait that valves on hydraulic side (if present) are completely open before to launch an alarm.

During the compressor operation there is another shorter bypass delay to avoid false alarms due to a transient situation.

The low water flow alarms are serious alarms. They block completely the unit and their automatic reset is based on the time the digital input remains open after the alarm detection.

The low water flow control operates during the working period of pump.

User's water sides

Par.	Description	Min	Max	U.M.
PA2	First Compressor ON delay from evap. pump starting-up	0	250	10sec
PA32	First Compressor ON delay from rec. pump starting-up	0	250	10sec
AL16	Evaporator flow switch alarm by-pass by activating the evaporator pump/supply fan	0	250	sec
AL17	Maximum time in evaporator flow switch alarm before switching to manual mode and blocking the evaporator water pump, if moving	0	250	sec
AL18	Evaporator flow switch / thermal overload supply fan input active duration	0	250	sec

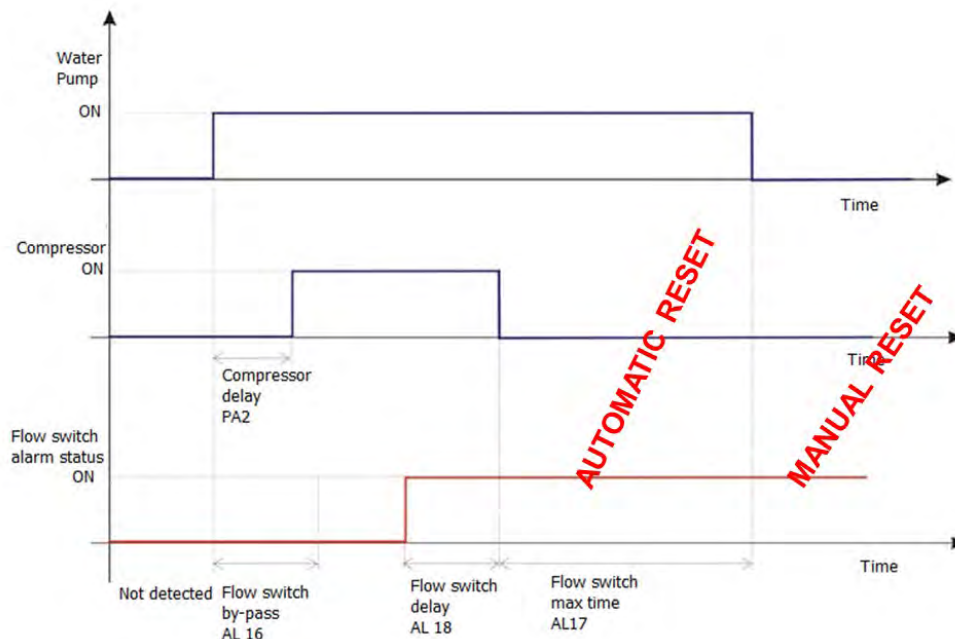

Warning: Value of parameter **AL 16** have **not** to **exceed** the value of parameters **PA 2** or **PA 32**.

Warning: For **Partial Heat Recovery** is not configured any kind of low water flow control

Source water side on water cooled units

On water cooled unit version the low flow alarm on source water side works as well as to the one described above.

The graph above is still valid but the parameters engaged to control are different.

Par.	Description	Min	Max	U.M.
PA18	First Compressor ON delay from source pump starting-up	0	250	10sec
AL22	Condenser flow switch alarm delay from when condenser water pump is activated	0	250	sec
AL23	Maximum time in condenser flow switch alarm before switching to manual mode and blocking the condenser water pump, if moving	0	250	sec
AL24	Active condenser flow switch input duration	0	250	sec

Warning: Value of parameter **AL 22** have **not** to **exceed** the value of parameters **PA 18**.

9. Water Freeze Protection Management

The water freeze protection loop is based on water temperature measured by a sensor installed on the exchanger close to the water outlet port.

The low water temperature alarms are serious alarms. They block completely the unit and their reset is only manual and there are no present bypass delays.

Warning: Factory settings of all units are for application **without glycol**.

Evaporator

In the control loop on evaporator side there are 3 different thresholds with different values according the operating mode.

At the first, the highest value, the microprocessor reduces the capacity of the unit to the minimum percentage not respecting timings of temperature control. This action is valid only if the chilled water production is in operation.

At the second one the microprocessor activates exchanger heaters and the water pump, in case evaporator pump is not in operation.

The third threshold, the lowest value, is to launch the alarm and to stop the entire unit.

Par.	Description	Min	Max	U.M.
UN6	Compressor unloading set point from the evaporator low water temperature	-50.0	110.0	°C
UN7	Compressor unloading differential from the evaporator low water temperature	0.1	25.0	°C
AR1	Antifreeze/support heaters set point in chiller mode	-50.0	110.0	°C
AR2	Anti-freeze/support heaters band regulation in chiller mode	0.1	25.0	°C
AL32	Anti-freeze minimum set point limit in chiller mode	-50.0	AL33	°C
AL33	Anti-freeze maximum set point limit in chiller mode	AL32	110.0	°C
AL34	Chiller anti-freeze alarm setting	AL32	AL33	°C
AL35	Anti-freeze alarm differential in chiller	0.1	25.0	°C
AR3	Antifreeze/support heaters set point in heat pump mode	-50.0	110.0	°C
AR4	Anti-freeze/support heaters band regulation in heat pump mode	0.1	25.0	°C
AL39	Anti-freeze minimum set point limit in heat pump mode	-50.0	AL40	°C
AL40	Anti-freeze maximum set point limit in heat pump mode	AL39	110.0	°C
AL41	Heat pump anti-freeze alarm setting	AL39	AL40	°C
AL42	Anti-freeze alarm differential in heat pump	0.1	25.0	°C

Heat Recovery

In the control loop on heat recovery water side there are 2 threshold.

At the first one the microprocessor activates exchanger heaters and the water pump, in case heat recovery pump is not in operation.

The second threshold, the lowest value, is to launch the alarm and to stop the entire unit.

Par.	Description	Min	Max	U.M.
AL72	Anti-freeze minimum set point limit recovery	-50.0	AL73	°C
AL73	Anti-freeze maximum set point limit recovery	AL72	110.0	°C
AL74	Recovery anti-freeze alarm setting	AL72	AL73	°C
AL75	Anti-freeze alarm differential Recovery	0.1	25.0	°C

Warning: For **Partial Heat Recovery** is not configured any kind of low water temperature control

Source water side on water-cooled units

In the control loop on chilled water side there are 2 threshold.

At the first one the microprocessor activates exchanger heaters and the water pump, in case this exchanger is not used and pump is not in operation.

The second threshold, the lowest value, is to launch the alarm and to stop the entire unit.

Par.	Description	Min	Max	U.M.
AL86	Anti-freeze minimum set point limit condenser in chiller mode	-50.0	AL87	°C
AL87	Anti-freeze maximum set point limit condenser in chiller mode	AL86	110.0	°C
AL88	Anti-freeze alarm setting condenser in chiller mode	AL86	AL87	°C
AL89	Anti-freeze alarm differential condenser in chiller mode	0.1	25.0	°C
AL90	Anti-freeze minimum set point limit condenser in heat pump mode	-50.0	AL91	°C
AL91	Anti-freeze maximum set point limit condenser in heat pump mode	AL90	110.0	°C
AL92	Anti-freeze alarm setting condenser in heat pump mode	AL90	AL91	°C
AL93	Anti-freeze alarm differential condenser in heat pump mode	0.1	25.0	°C

10. Condensing Fans Management

Units could be equipped with fan management in order to control the **condensing** or **evaporating pressure** according the operating mode.

Two different types are available related to the unit noise version and to the selected optional:

- Step control
- Continuous control.

Condensing Step Control

Par.	Description	Min	Max	U.M.
FA10	Minimum fan speed setting in chiller mode / First step setting	0.0	50.0	bar
FA11	Maximum fan speed setting in chiller mode / Second step setting	0.0	50.0	bar
FA12	Proportional band regulation in chiller mode / Differential on circ.1 steps	0.1	14.0	bar
FA13	CUT-OFF differential in chiller mode / Differential on circ.2 steps	0.1	14.0	bar
FA25	Third step setting in chiller mode	0.0	50.0	bar
FA26	Fourth step setting in chiller mode	0.0	50.0	bar
FA27	Differential on circ.3 steps in chiller mode	0.1	14.0	bar
FA28	Differential on circ.4 steps in chiller mode	0.1 <td 14.0	bar	

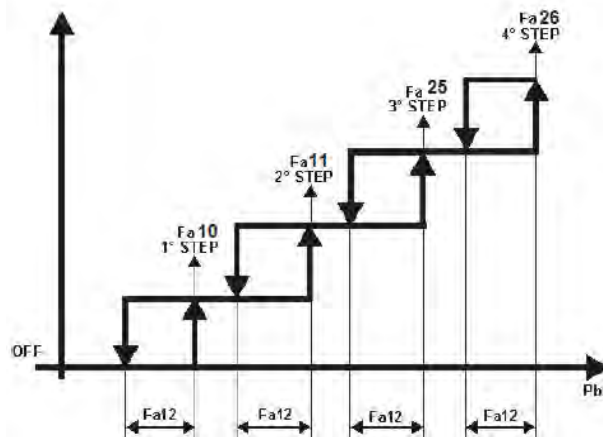

Evaporating Step Control

Par.	Description	Min	Max	U.M.
FA19	Maximum fan speed setting in HP mode / Fourth step setting	0.0	50.0	bar
FA20	Minimum fan speed setting in HP mode / Third step setting	0.0	50.0	bar
FA21	Proportional band regulation in HP mode / Differential on steps of circ.1	0.1	14.0	bar
FA22	CUT-OFF differential in HP mode / Differential on circ.2 steps	0.1	14.0	bar
FA29	Second step setting in heat pump mode	0.0	50.0	bar
FA30	First step setting in heat pump mode	0.0	50.0	bar
FA31	Differential on circ.3 steps in HP mode	0.1	14.0	bar
FA32	Differential on circ.4 steps in HP mode	0.1	14.0	bar

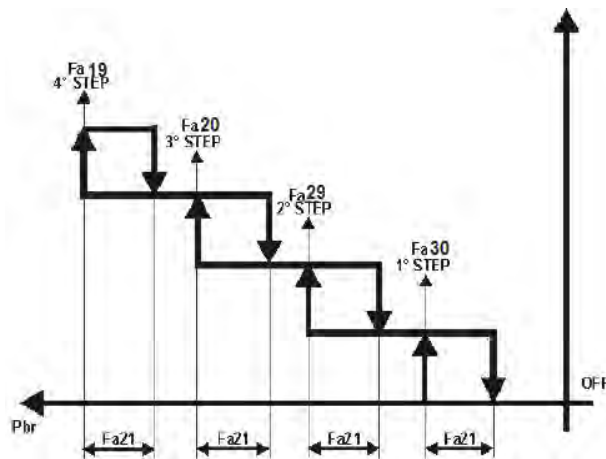

Warning: To avoid **Configuration alarm n°2** it is necessary to respect these mathematics rules:

- $FA10 < FA11 < FA25 < FA26$
- $FA19 < FA20 < FA29 < FA30$

Continuous Condensing Control

Par.	Description	Min	Max	U.M.
FA8	Minimum operation speed of the chiller fans	0	FA16	%
FA9	Maximum operation speed of the chiller fans	FA16	100	%
FA10	Minimum fan speed setting in chiller mode / First step setting	0.0	50.0	bar
FA11	Maximum fan speed setting in chiller mode / Second step setting	0.0	50.0	bar
FA12	Proportional band regulation in chiller mode / Differential on circ.1 steps	0.1	14.0	bar
FA13	CUT-OFF differential in chiller mode / Differential on circ.2 steps	0.1	14.0	bar
FA14	CUT OFF over ride in chiller mode	0.1	14.0	bar
FA16	Night function speed in chiller mode	FA8	FA9	%

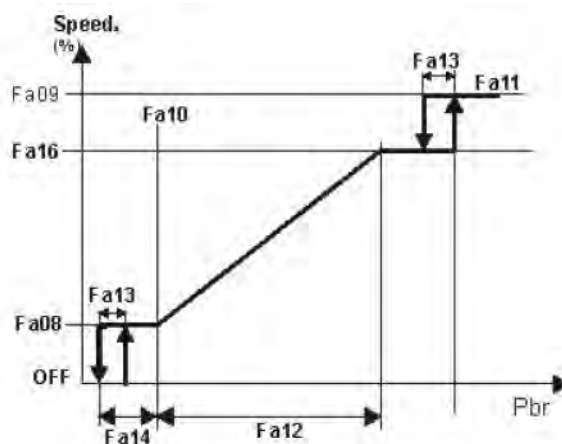

Continuous Evaporating Control

Par.	Description	Min	Max	U.M.
FA17	Minimum fan speed in heat pump mode	0	70	%
FA18	Maximum fan speed in heat pump mode	70	100	%
FA19	Maximum fan speed setting in HP mode / Fourth step setting	0.0	50.0	bar
FA20	Minimum fan speed setting in HP mode / Third step setting	0.0	50.0	bar
FA21	Proportional band regulation in HP mode / Differential on steps of circ.1	0.1	14.0	bar
FA22	CUT-OFF differential in HP mode / Differential on circ.2 steps	0.1	14.0	bar
FA23	CUT OFF over ride in HP mode	0.1	14.0	bar
FA24	Night function speed in HP mode	30	100	%

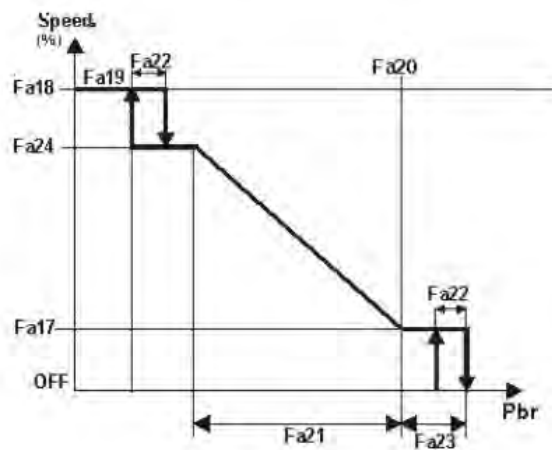

Warning: To avoid **Configuration alarm n°2** it is necessary to respect these mathematics rules:

- $FA10+FA12+FA13 < FA11$
- $FA13 < FA14$
- $FA19+FA22+FA21 < FA20$
- $FA22 < FA23$

11. Safety Unloading

The controller manages the forced unloading of the refrigerant circuits when they are working in critical conditions in order to guarantee a continuity of service even in the most heavy duty conditions.

The safety unloading function could acts:

1. **High return water temperature** during cooling production in order to reduce the current absorption
2. **Low leaving water temperature** during cooling production in order to reduce the risk of freeze alarm protection as reported on chapter 8.
3. **High condensing pressure** in order to reduce the risk of High pressure cut out
4. **Low evaporating pressure** in order to reduce the risk of Low pressure cut out

This function is priority respect the normal temperature control and at its activation the parameter CO5 is not respected, in fact the controller acts all resource to reduce the capacity of the circuits at minimum as fast as possible.

Par.	Description	Min	Max	U.M.
UN1	Unloading set point for evap. high return water temperature in cooling	-50.0	110.0	°C
UN2	Unloading differential for evap. high return water temperature in cooling	0.1	25.0	°C
UN3	Delay for evap. high return water temperature unloading function to be inserted	0	250	10sec
UN4	MAX time in unloading function due to the evap. high return water temperature in cooling	0	250	min
UN6	Unloading set point for evap. low leaving water temperature in cooling	-50.0	110.0	°C
UN7	Unloading differential for evap. low leaving water temperature in cooling	0.1	25.0	°C
UN8	Delay for the evap. low leaving water temperature unloading function to be inserted	0	250	10sec
UN9	MAX time in unloading status due to the evap. low leaving water temperature in cooling	0	250	min
UN11	Condensing temperature/pressure unloading set point	0.0	50.0	bar
UN12	Condensing temperature/pressure unloading differential	0.1	14.0	bar
UN13	Evaporation pressure unloading set point	-1.0	50.0	bar
UN14	Evaporation pressure unloading differential	0.1	14.0	bar
UN15	MAX time in temperature / pressure unloading status	0	250	min

12. Defrost Management

The heat pumps with the advanced control are equipped with the Digital defrost control loop, in order to minimize the number of defrosts and maximize their effectiveness.

This control loop is based on the difference between the designed evaporating coil approach (difference between evaporating temperature and the ambient temperature) and the measured one, below an evaporating pressure threshold.

There are adjustable delays to avoid two consecutive defrosts in a short time on the same circuit or between two different circuits of the unit.

A defrost cycle will be performed only if these conditions are true at the same time:

- Evaporating pressure below control threshold
- Delay between two defrost is expired
- Measured approach is worse than the designed one for that specific operating condition

There is also a second lower set point to force a defrost cycle after a shorter delay.

The end of the defrost cycle is based on reaching of the end defrost pressure value before than the maximum duration counter expires.

Generic defrost parameters

Par.	Description	Min	Max	U.M.
DF2	Defrost begins by temperature/pressure	0.0	50.0	bar
DF3	Defrost ends by temperature/pressure	0.0	50.0	bar
DF4	Minimum defrost duration	0	250	sec
DF5	Maximum defrost duration	1	250	min
DF6	Defrost delay between two circuits	0	250	min
DF7	Idle time in compressor OFF mode before defrosting	0	250	sec
DF8	Idle time in compressor OFF mode after defrosting	0	250	sec
DF9	Defrost interval in the same circuit	1	99	min
DF30	Forced defrosting temperature/pressure setting	0.0	50.0	bar
DF31	Forced defrosting differential	0.1	14.0	bar

Digital Defrost parameters

Par.	Description	Min	Max	U.M.
DF35	Lower set outdoor air temperature	-50.0	0.0	°C
DF36	Medium set outdoor air temperature	-7.0	7.0	°C
DF37	Upper set outdoor air temperature	0.0	110.0	°C
DF38	Set point defrost delta-T outdoor air temperature higher DF37	-50.0	110.0	°C
DF39	Set point defrost delta-T outdoor air temperature between DF37 and DF36	-50.0	110.0	°C
DF40	Set point defrost delta-T outdoor air temperature between DF36 and DF35	-50.0	110.0	°C
DF41	Set point defrost delta-T outdoor air temperature less than DF35	-50.0	110.0	°C

13. Energy Saving and Auto On / Off

The **Energy Saving** is the function to “reset” the water set points to save energy in particular conditions of plant requests.

There are two different ways to activate this function:

1. Using Time slots
2. Using digital inputs (called commonly Double set point)

To use this function according the mode 1, it is necessary to set the time slots within the sub-menu “**Time bands**” as reported on **Chapter 3.4.2**, and to set, in the parameter group **ES**, the amount to “add” to the set points and the value of the unit regulation band when this function is in operation.

This parameters shall be set also to use the mode 2.

Par.	Description	Min	Max	U.M.
ES14	Increasing value of chilled water set point in Energy Saving mode	-50.0	110.0	°C
ES15	Chilled water regulation band in Energy saving mode	0.1	25.0	°C
ES16	Increasing value of hot water set point in Energy Saving mode	-50.0	110.0	°C
ES17	Hot water regulation band in Energy saving mode	0.1	25.0	°C

The **second** mode is **priority** respect the mode 1.

To enable the **Auto On/Off**, it is sufficient to set the time slots within the sub-menu “**Time bands**” as reported on **Chapter 3.4.2**.

	Start Band	Finish Band	Energy Saving	Auto ON/OFF
Band 1	00,00	05,00	Band 2 e 3	Band 1
Band 2	05,00	08,00	Band 2 e 3	Band 1
Band 3	21,00	24,00	Band 2 e 3	Band 1

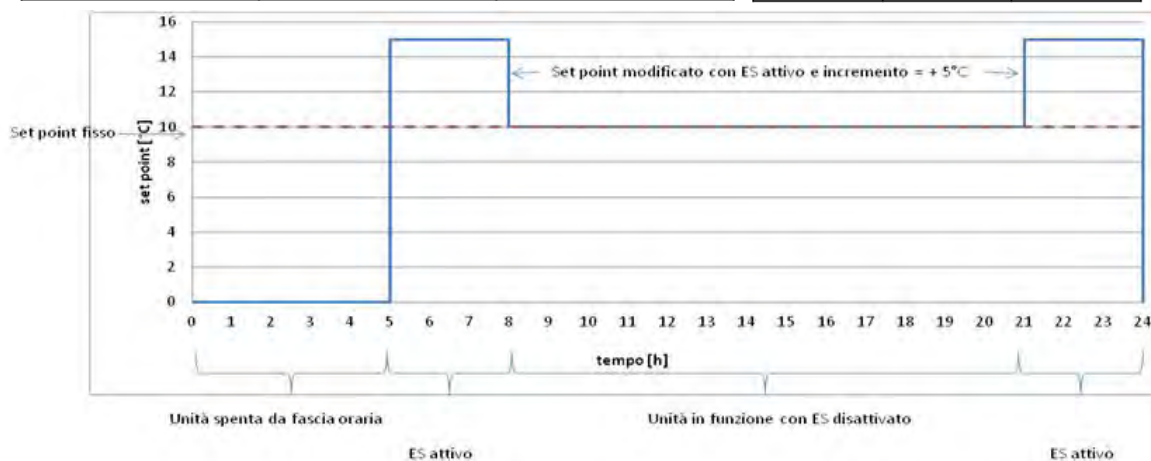

14. Dynamic Set Point

The **Dynamic Set Point** is the function to “reset” the water set points, according a proportional curve, to save energy in particular conditions.

There are two different ways to use this function:

1. Using Outdoor Temperature
2. Using an external signal 4-20mA (called commonly Remote set point)

To use this function according the mode 1, it is necessary to set, in the parameter group **SD**, the amount to “add” to the set points and the ambient temperature range where this function will operate.

To use this function according the mode 2, it is necessary **to configure the 4-20mA** external signal and to set, in the parameter group **SD**, the amount to “add” to the set points proportionally to the external signal value.

Par.	Description	Min	Max	U.M.
SD1	Maximum increasing value of chilled water set point in D.S.P. mode	-50.0	110.0	°C
SD2	Maximum increasing value of hot water set point in D.S.P. mode	-50.0	110.0	°C
SD3	External air temperature set point to activate D.S.P. on chilled water	-50.0	110.0	°C
SD4	External air temperature set point to activate D.S.P. on hot water	-50.0	110.0	°C
SD5	External air temperature differential for D.S.P. variation on chilled water	-25.0	25.0	°C
SD6	External air temperature differential for D.S.P. variation on hot water	-25.0	25.0	°C

The **second** mode is **priority** respect the mode 1.

The **mode 1** is **available** only for **air cooled** versions.

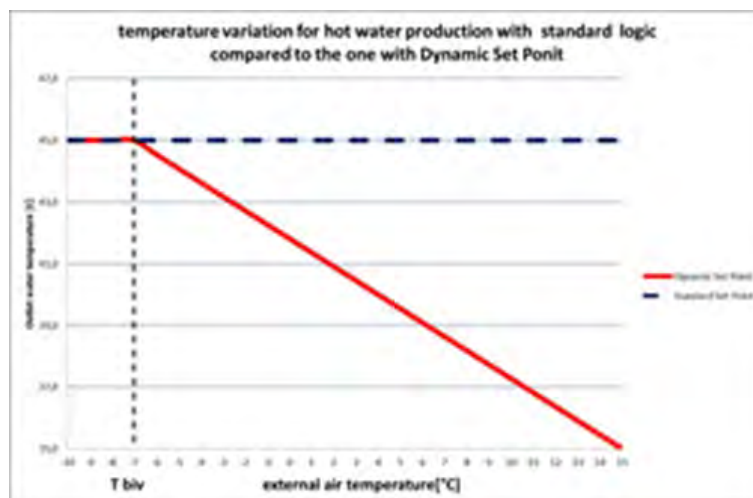

15. Log Files Management

The controller records on a non-volatile memory, approximately the last 4 days of operation.

Plugging an USB stick in the controller and entering in the control panel it is possible to “Send all logs to a USB” selecting “files log management” submenu, as reported on chapter 3.4.13 and 4.4.13.

The microprocessor creates a folder “ipro” with inside three files of alarms:

- “alarm_a” where records all alarms that stop the unit
- “alarm_b” where records all alarms that stop the specific refrigerant circuit
- “alarm_c” where records all alarms that stop the specific compressor

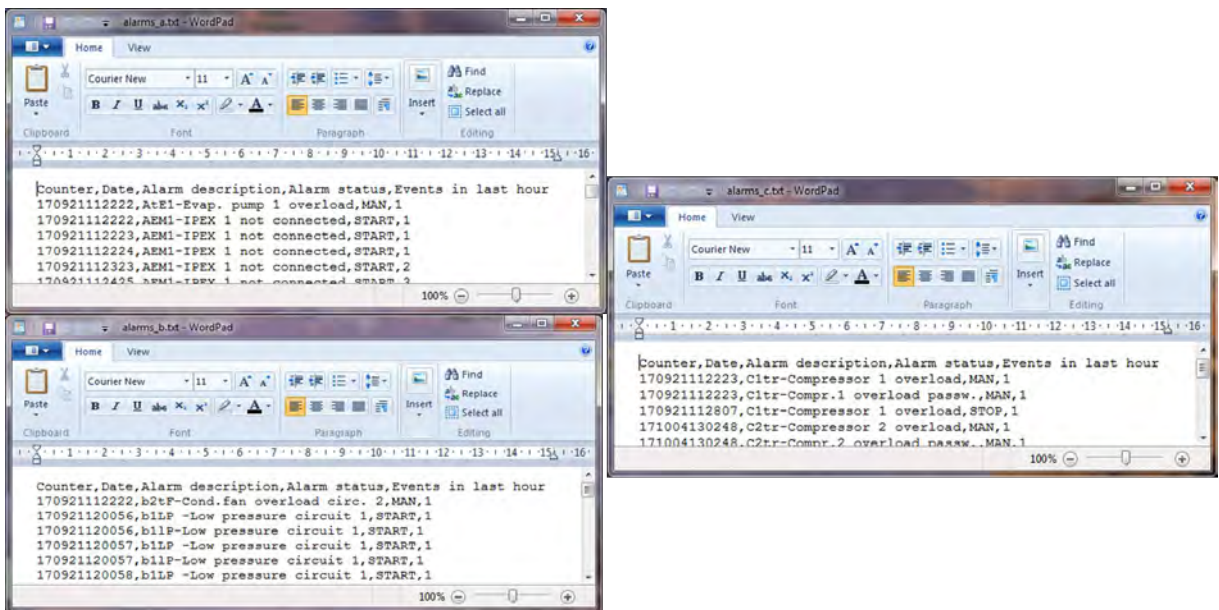

All of these files are in “.txt” format and inside the recording date is in the format YY/MM/DD/hh/mm/ss.

- “accesslog” where records the parameters modifications with the previous and the new value

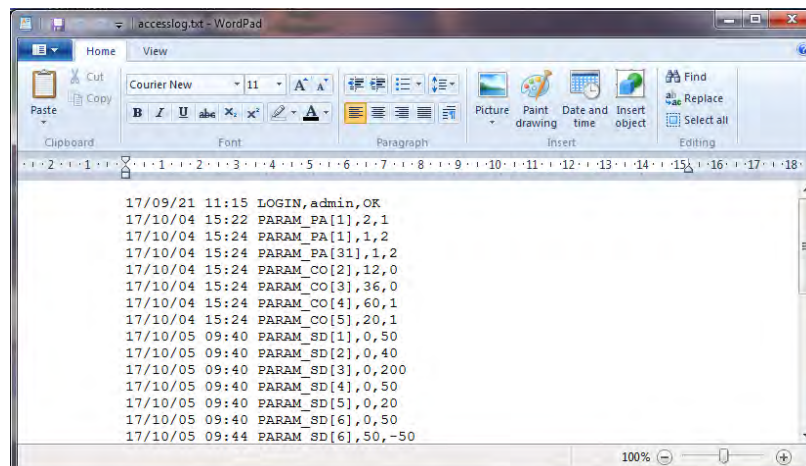

This file is in “.txt” format and inside the recording date is in the format YY/MM/DD hh:mm.

- “**Unit10Din**” where records the last 4 days of operation with status and value of the main variables

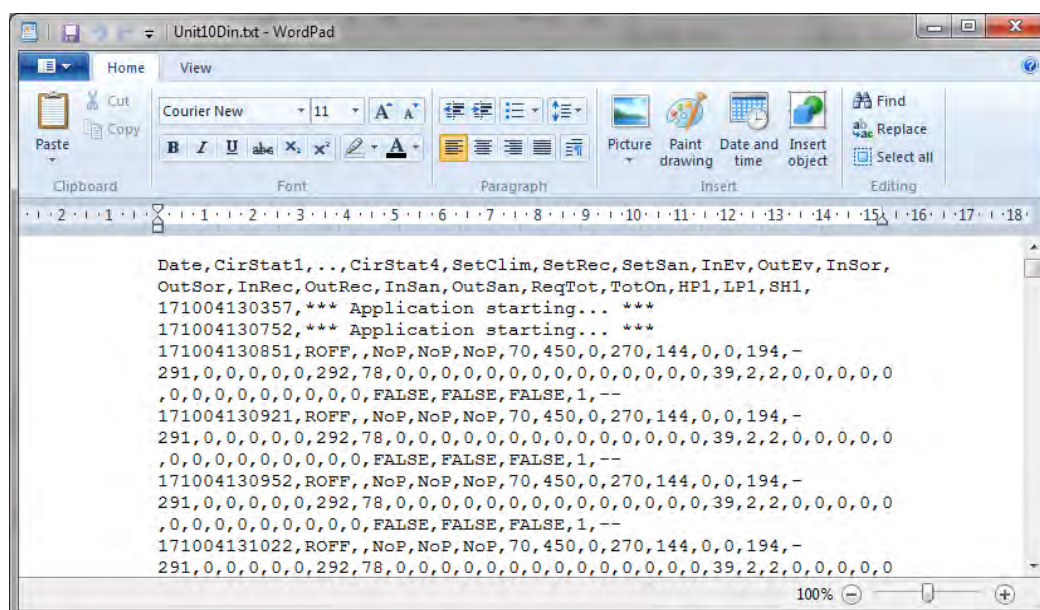

This file is in “.txt” format and inside the recording date is in the format YY/MM/DD/hh/mm/ss.

Warning: Before log files download make sure that into the **USB** stick there is no folder named “ipro”.

16. Remote Control

To control the unit remotely are available different ways:

- Free contacts reported in customer terminal block (X);
- Bus protocol;
- Remote keypad

16.1. Remote Control via Free Contacts

In the electrical cabinet, on the customer terminal block (X) are present dry contacts where it is possible to connect:

- To the unit
 - Remote General On/Off
 - Remote Summer/Winter mode selection
 - Flow switches status
 - Water pumps alarm status (external hydraulic groups)
 - Digital input for Double set point
 - Analog input for External set point
- From the unit
 - Generic alarm status
 - Water pumps enabling commands
 - Unit status

In the unit wiring diagram is reported the contacts list with the terminal strips number.

=0G					=0G - X				
X									
Num	LVV	Num	Utenza	FgCat					
1	1/2	114	External set point (if request)	25.6					
	2/2	114	External set point (if request)	25.6					
2	1/2	A24	Double set-point (if request)	24.6		108		116	
	2/2	158	Double set-point (if request)	24.6		158		A24	
3	1/2	A24	Run/No On/ OFF	23.3		143		A24	
	2/2	143	Run/No On/ OFF	23.3		18		17	
4	1/2	A24	External evaporator pump protection FPE	19.6		16		15	
	2/2	16	External evaporator pump protection FPE	19.6		13		12	
5	1/2	17	External recovery pump protection PPP	19.2		302		301	
	2/2	16	External recovery pump protection PPP	19.2		304		305	
6	1/2	15	Recovery water flow switch FLR	19.2		306		307	
	2/2	16	Recovery water flow switch FLR	19.2		308		309	
7	1/2	12	Evaporator flow switch FLE	19.1		310		311	
	2/2	13	Evaporator flow switch FLE	19.1		312		310	
8	1/2	301	Free voltage contact compressor 1 status circ 1 (00)	31.0		321		322	
	2/2	302	Free voltage contact compressor 1 status circ 1 (00)	31.0		323		331	
9	1/2	303	Free voltage contact compressor 2 status circ 1 (00)	31.1		333		331	
	2/2	304	Free voltage contact compressor 2 status circ 1 (00)	31.1		336		334	
10	1/2	305	Free voltage contact compressor 1 status circ 2 (00)	31.3					
	2/2	306	Free voltage contact compressor 1 status circ 2 (00)	31.3					
11	1/2	307	Free voltage contact compressor 2 status circ 2 (00)	31.4					
	2/2	308	Free voltage contact compressor 2 status circ 2 (00)	31.4					
12	1/2	309	Alarm general relay free voltage - circuit 1 (00)	31.6					
	2/2	310	Alarm general relay free voltage - circuit 1 (00)	31.6					
13	1/2	311	Alarm general relay free voltage - circuit 2 (00)	31.6					
	2/2	312	Alarm general relay free voltage - circuit 2 (00)	31.6					
14	1/2	320	Request v. pump emergency free voltage (00)	31.8					
	2/2	321	Request v. pump emergency free voltage (00)	31.8					
15	1/2	322	Request v. pump recovery free voltage (00)	31.9					
	2/2	323	Request v. pump recovery free voltage (00)	31.9					
16	1/2	331	Alarm failure to initialize evaporator water pump	31.7					
	2/2	332	Alarm failure to initialize evaporator water pump	31.7					
17	1/2	334	Alarm failure to initialize recovery water pump	31.7					
	2/2	336	Alarm failure to initialize recovery water pump	31.7					
18		116	Start pumps simultaneously	23.5		176			
19		119	Start pumps simultaneously	23.6		179			
20	F	F	Start pumps simultaneously sub pumps	24.1		F			
21	40	40	Start pumps simultaneously sub pumps	24.1		40			
50	L-W1	L0Nv00RKS		29.6		L-W1			
51	L-W2	L0Nv00RKS		29.7		L-W2			

16.2. Remote Control via Bus Protocol

Chillers and heat pumps with the advanced control can be integrated in a Building Automation System via MODbus® RTU, LonTalk®, or BACnet® MSTP or IP.

All info necessary for the integration of the units are reported in the “**Integration Guide**” starting from the manual code: **MU-COMM-E-EL-REV2.0.1-1017-UK**.

16.3. Control via Remote Keypad

It is possible to connect a second keypad in parallel to the one of the unit as the connection diagram below.

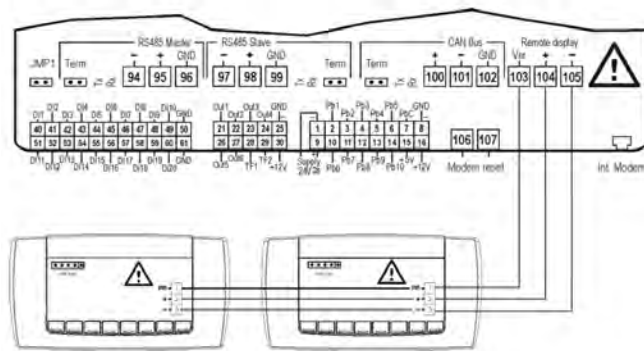

Wrong wiring may cause serious damage to the keypads or controller.

It should be necessary an updating of the keyboard once connected the second one as reported on chapter 3.4.13.

Trane - by Trane Technologies (NYSE: TT), a global climate innovator - creates comfortable, energy efficient indoor environments for commercial and residential applications. For more information, please visit trane.eu or tranetechnologies.com. Trane has a policy of continuous product and product data improvement and reserves the right to change design and specifications without notice.

PROD-SVU001C-GB_0420
Supersedes PROD-SVU001B_1118

©2020 Trane