



LSTE COOLING TOWERS

NEW!

**Eurovent-CTI
CERTIFIED**



LOW SOUND

FORCED DRAFT, COUNTERFLOW COOLING TOWERS

Thermal Performance from 145 to 5930 kW Nominal Capacity

DELIVERING QUALITY... FOCUSED ON PERFECTION!

CERTIFIED EN ISO 9001



LSTE



Since its founding in 1976, EVAPCO, Inc. has become a world-wide leader in supplying quality cooling equipment for thousands of customers in both the commercial and industrial markets.

EVAPCO's success has been the result of a continual commitment to product improvement, quality workmanship and a dedication to providing unparalleled service.



Our emphasis on research and development has led to many product innovations – a hallmark of EVAPCO through the years.

The ongoing R & D Program enables EVAPCO to provide the most advanced products in the industry – technology for the future, available today.

With 19 facilities in nine countries and over 175 sales offices in 51 countries world-wide, EVAPCO is ready to assist in all your equipment needs.

The new & improved EVAPCO Model LSTE forced draft centrifugal cooling towers now feature IBC Compliance in addition to CTI-ECC Certification. These features reinforce EVAPCO's position as the leading manufacturer of forced draft evaporative cooling equipment.

Z-725 Heavy Mill Galvanized Steel Construction

(Stainless steel available as an affordable option)

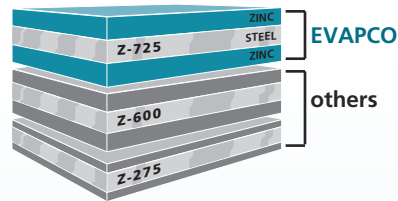

NEW! Easy Field Assembly

- Ensures easy assembly and fewer fasteners.
- Incorporates self-guiding channels to guide the casing section into position improving the quality of the field seam.



Stainless Steel Strainer

- Resists corrosion better than other materials

NEW! Clean Pan Design

- Sloped design allows water to drain completely from cold water basin.
- Easier removal of dirt and debris.



DESIGN AND CONSTRUCTION FEATURES



IBC Compliant Design
 Refer to page 13 for details



NEW! Fully Integrated Water Saver Drift Eliminators

- New patented design reduces drift rate to < 0.001%
- Saves water and reduces water treatment cost
- Greater structural integrity vs. old style blade-type
- Eliminators now integrated within casing section for easy mounting of ductwork, discharge hood and attenuation
- Drift rate certifications Eurovent OM-14-2009



PVC Spray Distribution Header

- Nozzles are threaded into the header to ensure proper orientation.
- Fixed position nozzles require little maintenance.
- Large orifice nozzle with integral sludge ring to prevent clogging.
- Treaded end-caps on distribution piping for ease of cleaning.

Exclusive EVAPAK® fill

- Provides the most efficient thermal performance per plan area
- Suitable for use as a working platform

Totally Enclosed Fan Motors & Superior Drive System

- Assures long life
- Located in dry, incoming air-stream, allowing normal maintenance to be done from the outside of the unit
- If required, motor can be easily removed
- One piece fan shaft
- Belt tensioning and bearing lubrication can be performed from outside the unit
- Motor is fully accessible by removing one inlet screen

Eurovent-CTI Certified
 Refer to page 15 for details



† Mark owned by the Cooling Technology Institute

LSTE

DESIGN FEATURES

Principle of Operation

Warm water from the heat source is pumped to the water distribution system at the top of the tower. The water is then distributed over the wet deck fill by means of large orifice nozzles. Simultaneously, air is forced-up through the fill section via centrifugal fans. A small portion of the water is evaporated, which removes the heat from the remaining water. The warm moist air is forced to the top of the cooling tower and discharged to the atmosphere. The cooled water then drains to the basin at the bottom of the tower where it is returned to the heat source.

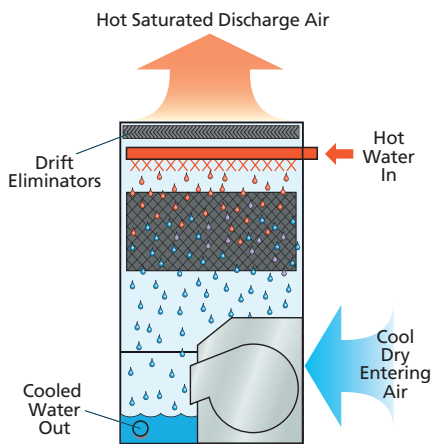

Application Versatility

Centrifugal fan units are recommended for a wide range of installations. They are excellent for larger installations where very quiet operation is a must, such as residential neighborhoods. In addition, centrifugal fan units can operate against the static pressure loss of ductwork and are ideal for indoor installations.



LSTE unit

Very Quiet Operation

Centrifugal fan units provide an inherently low noise characteristic which makes this design preferred for most installations that require low sound levels. The sound they produce is predominantly in the high frequencies which is easily attenuated by building walls, windows, and natural barriers. Additionally, since the sound from the fans is directional, single sided air entry models can be turned away from critical areas avoiding a sound problem. When even quieter operation is necessary, centrifugal fan models can be equipped with optional sound attenuation packages. Consult the factory for details.

Indoor Installation

Centrifugal cooling towers can be installed indoors when it is desirable to hide the unit or when it is the only space available. In addition to being quiet, they can handle the external static pressure of ductwork by using the next larger size fan motor. Drawings are available showing how to make ductwork connections.

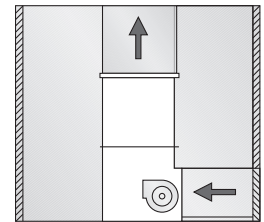

Blow-Thru Construction

All moving parts of Forced Draft Towers-fans, motors, bearing, drives, and belts, are in the the dry entering air stream. This design feature reduces corrosion and maintenance problems in these vital areas.

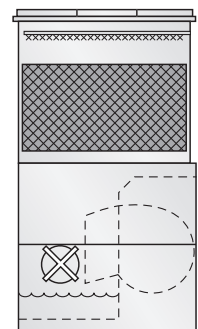

DESIGN FEATURES

Low Installed Costs

The LSTE forced draft cooling tower is designed using a modular concept to minimize rigging, piping and support costs. All major components are factory assembled into complete sections.

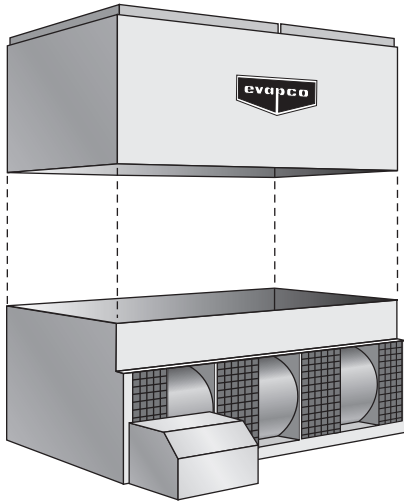

Fans, shafts, bearings and drives are installed and aligned at the factory as an integral part of the pan section to eliminate the necessity of field rigging these key parts.

Fan Motors

All LSTE models utilize heavy duty totally enclosed fan motors (T.E.F.C.) designed specifically for cooling tower applications. In addition, EVAPCO offers many optional motors to meet your specific needs.

Fan Motor Location

EVAPCO mounts the fan motor in a convenient open area to make it easy to adjust belt tension, access the motor, electrically connect it, or change the motor if necessary. The fan motor and drive are under a protective cover for safety purposes and to protect them from the elements.

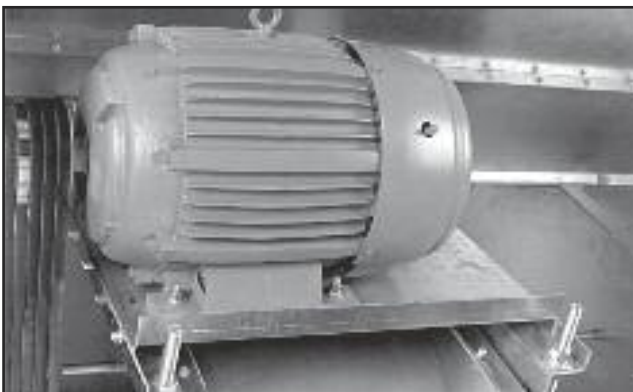

LARGE SERIES MOTOR MOUNT

Centrifugal Fan Assembly

Fans on the LSTE models are of the forward curved centrifugal type with hot-dip galvanized steel construction. All fans are statically and dynamically balanced and mounted in a hot-dip galvanized steel housing designed and manufactured by EVAPCO.



CENTRIFUGAL WHEEL

LSTE

DESIGN FEATURES

Capacity Control

All LSTE models come standard with an efficient, inverter-ready fan motors that can be used with variable frequency drive (VFD) systems for precise capacity control. VFD systems can control the speed of a fan motor by modulating the voltage and frequency of the motor input electrical signal. When connected to a building automation system a VFD can receive signals varying fan speeds to meet demand loads. This popular method of capacity control can yield significant energy savings.

Evapco offers two-speed fan motors as an option for alternative capacity control. In periods of lightened loads or reduced wet bulb temperatures the fans can operate at low speed providing about 60% of full speed capacity yet consuming only about 15% of full speed power. These motors do not require the use of VFD systems however they can only operate at two speeds: full or low.

Basin Access

The basin/fan section of a centrifugal fan unit is designed for accessibility and ease of maintenance.

Large circular access doors are provided to allow entry into the basin. All float valve and strainer assemblies are located near the door for easy adjustment and cleaning. The sump is designed to catch the dirt accumulated. This can be flushed out simply with a hose. The stainless steel strainers may be easily removed for periodic cleaning.

Efficient Drift Eliminators*

An extremely efficient drift eliminator system is standard on the LSTE Cooling Tower. The system removes entrained water droplets from the air stream to limit the drift rate to less than 0.001% of the recirculating water rate. With a low drift rate, the LSTE Cooling Tower saves valuable

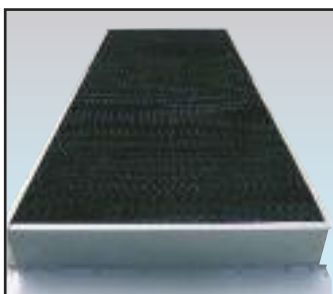

ELIMINATOR

water and water treatment chemicals. The LSTE can be located in areas where minimum water carryover is critical, such as parking lots.

The drift eliminators are constructed of an inert polyvinyl chloride (PVC) plastic material which effectively eliminates corrosion of these vital components. They are assembled in sections to facilitate easy removal for inspection of the water distribution system. EVAPCO can provide the Eurovent drift rate certificate in accordance with OM-14-2009.

Stainless Steel Strainers

One other component of evaporative cooling equipment which is subject to excessive wear is the suction strainer. **EVAPCO provides a Type 304 stainless steel strainer on all units as standard** (except remote sump applications). Strainers are positioned around a large anti-vortex hood in easily handled sections.



STRAINER

*U.S. Patent No. 4,500,330

DESIGN FEATURES

EVAPCOAT:

Z-725 Hot-Dip Galvanized Steel Construction

The Z-725 Mill Hot-Dip Galvanized Steel Construction is the heaviest level of galvanizing available for manufacturing evaporative cooling towers and has more zinc protection than competitive designs using Z-275 and Z-600 steel.

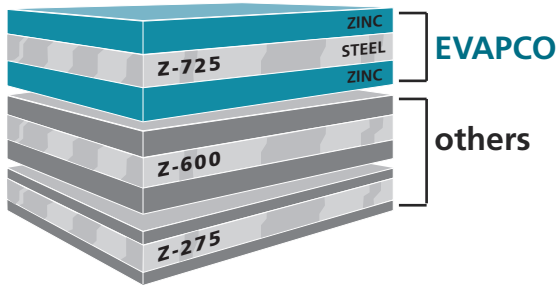

EVAPCO has been a leader in the industry in developing heavier galvanizing, and was the first to standardize on Z-725 mill hot-dip galvanized steel. Z-725 designation means there is a minimum of 725 g/m² total zinc present on the steel.

During fabrication, all panel edges are coated with a 95% pure zinc-rich compound for extended corrosion resistance.

The EVAPCOAT Corrosion Protection System is the heaviest galvanized coating available for extended corrosion protection eliminating the need for costly, unreliable epoxy paint finishes.

Stainless Steel Material Options

The EVAPCO Corrosion Protection System is satisfactory for most applications. If additional corrosion protection is required the following stainless steel options are available (AISI 304 and 316). Please contact your local EVAPCO representative for pricing.

- Stainless Steel Cold Water Basins
- Stainless Steel Water Touch Basin
- Stainless Steel Water Touch Units
- All Stainless Steel Units

EVAPAK® Cooling Tower Fill

The patented* EVAPAK® fill design used in the forced draft cooling tower line is the culmination of thousands of hours of research and testing conducted by EVAPCO's research engineers. This program has produced a cooling tower fill with superior heat transfer, reduced channeling in flow passages, improved drip enhancement for lower air side pressure drop and exceptional structural strength.

The fill is specially designed to induce highly turbulent mixing of the air and water for heat transfer. This is made possible by forming the raw fill into corrugated panels on which there are small ridges. These ridges serve many purposes, one of which is to create agitation in both the water and the air in the tower. This increase in turbulence prevents channeling of the water and promotes better mixing of air and water, therefore improving heat transfer. In addition, special drainage tips allow high water loadings without excessive pressure drop.

The fill is constructed of inert polyvinyl chloride, (PVC). It will not rot or decay and is formulated to withstand water temperatures of 55°C. Because of the unique way in which the cross-fluted sheets are bonded together, the structural integrity of the fill is greatly enhanced, making the fill usable as a working platform.

A high temperature fill is available for water temperatures exceeding 55°C. Consult your EVAPCO representative for further details.

EVAPAK® FILL

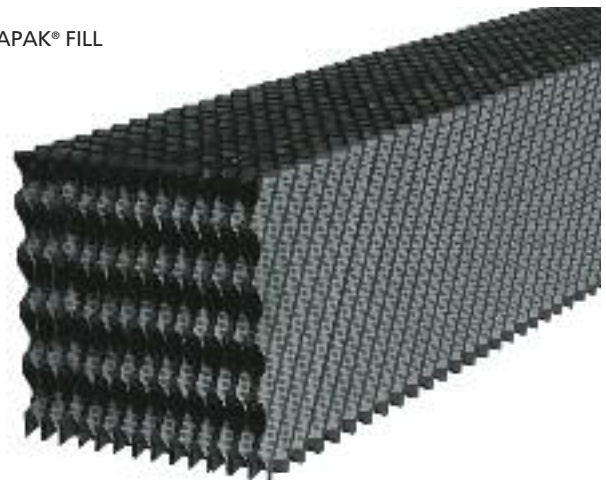

*U.S. Patent No. 5,124,087

LSTE

OPTIONAL EQUIPMENT

Pan Freeze Protection

Remote Sump

Whenever a cooling tower is idle during sub-freezing weather, the water in the sump must be protected from freezing and damaging the pan. The simplest and most reliable method of accomplishing this is with a remote sump tank located in a heated space in the building under the tower. With this system, the water in the tower drains to the indoor tank whenever the pump is shut-off. When a tower is ordered for remote sump operation, the standard float valve and strainer are omitted, and the unit is provided with an oversized water outlet connection. When a remote sump is not possible, a supplementary means of heating the pan water must be provided.

Electric Heaters

Electric immersion heaters are available factory installed in the basin of the tower. They are sized to maintain a +5°C pan water temperature at -18°C ambient with the fans off. They are furnished with a combination thermostat/low water protection device to cycle the heater on when required and to prevent the heater elements from energizing unless they are completely submerged. All components are enclosed in rugged, weather proof enclosures for outdoor use. Heater control packages are available as an option.

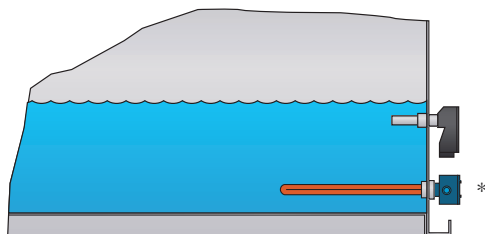

Basin Heater

*See factory certified prints for detailed drawings.

Unit No.	KW*	Unit No.	KW*
LSTE 416 to 466	2	LSTE 8P118 to 8P618 (2)	4
LSTE 419 to 439	3	LSTE 8P124 to 8P524 (2)	5
LSTE 4112 to 4612	3	LSTE 8P136 to 8P536 (2)	7
LSTE 4118 to 4518	5	LSTE 10112 to 10612	7
LSTE 5112 to 5512	4	LSTE 10118 to 10718 (2)	5
LSTE 5118 to 5718 (2)	3	LSTE 10124 to 10524 (2)	7
LSTE 8P112 to 8P512	5	LSTE 10136 to 10636 (2)	10

* Electric heater selection based on -18°C ambient temperature. For alternate low ambient heater selections, consult the factory.

Contact your EVAPCO representative for further details.

Electric Water Level Control

EVAPCO LSTE Cooling Towers are available with an optional electric water level control system in place of the standard mechanical makeup valve and float assembly. This package provides accurate control of the pan water level and does not require field adjustment, even under widely variable operating conditions.

The control was designed by EVAPCO and consists of multiple heavy duty stainless steel electrodes. These electrodes are mounted external to the unit in a vertical stand pipe. For winter operation, the stand pipe must be wrapped with electric heating cable and insulated to protect it from freezing. The weather protected slow closing solenoid valve for the makeup water connection is factory supplied and is ready for piping to a water supply with a pressure between 140 kPa (minimum) and 350 kPa (maximum).

Vibration Isolators

The fans on EVAPCO cooling towers are balanced and run virtually vibration free. In addition, the rotating mass is very small in relation to the total mass of the cooling tower, further reducing the possibility of objectionable vibration being transmitted to the building structure. As a result, vibration isolation is generally not required.

In those cases where it is determined that vibration isolation is necessary, spring type vibration isolator rails can be furnished. The rails are constructed of heavy gauge Z-725 hot-dip galvanized steel for superior corrosion resistance. Rails are designed to be mounted between the cooling tower and the supporting steel framework. They are 90% efficient and have approximately 25 mm static deflection. Rails are designed for wind loading up to 80 km/h. It is important to note that vibration isolation must be installed continuously along the full length of the cooling tower on both sides of the unit. Point isolators may be used between the supporting steel and the building framework, but not between the unit and the supporting steel.

IBC Certification cannot be given when vibration isolators are installed.

Other Options Available:

- Capacity Dampers and Controls
- Pony Motors
- Tapered Discharge Hoods
- Solid Bottom Panels
- Fill Access Door

OPTIONS

APPLICATIONS

EVAPCO LSTE Cooling Towers have heavy-duty construction and are designed for long, trouble-free operation. However, proper equipment selection, installation and maintenance are necessary to insure good unit performance. Some of the major considerations in the application of a cooling tower are presented below. For additional information, contact the factory.

Air Circulation

In reviewing the system design and unit location, it is important that enough fresh air is provided to enable proper unit performance. The best location is on an unobstructed roof top or on ground level away from walls and other barriers. Care must be taken when locating towers in wells or enclosures or next to high walls. The potential for recirculation of the hot, moist discharge air back into the fan intake exists. Recirculation raises the wet bulb temperature of the entering air causing the leaving water temperature to rise above design. For these cases, a discharge hood or ductwork should be provided to raise the overall unit height even with the adjacent wall, thereby reducing the chance of recirculation. For additional information see the EVAPCO Equipment Layout Manual. Engineering assistance is also available from the factory to identify potential recirculation problems and recommend solutions.

Piping

Cooling tower piping should be designed and installed in accordance with generally accepted engineering practices. All piping should be anchored by properly designed hangers and supports with allowance made for possible expansion and contraction. No external loads should be placed upon cooling tower connections, nor should any of the pipe supports be anchored to the unit framework.

Maintaining the Recirculated Water System

The cooling in a tower is accomplished by the evaporation of a portion of the recirculated spray water. As this water evaporates, it leaves behind all of its mineral content and impurities. Therefore, it is important to bleed-off an amount of water equal to that which is evaporated to prevent the buildup of impurities. If this is not done, the mineral content and/or the corrosive nature of the water will continue to increase. This will ultimately result in heavy scaling or a corrosive condition.

Bleed-off

A bleed line should be installed in the piping, external to the unit. The bleed line must be properly sized for the application and provided with a metering connection and globe valve. The recommended bleed off for a cooling tower is equivalent to the evaporation rate of 1,58 l/h per kW of cooling. If the make-up water supplying the unit is relatively free of impurities, it

may be possible to cut back the bleed, but the unit must be checked frequently to make sure scale is not forming. Make-up water pressure must be maintained between 140 and 350 kPa for proper operation of the float valve.

Water Treatment

In some cases the make-up water will be so high in mineral content that a normal bleed-off will not prevent scaling. In this case, water treatment will be required. If chemical water treatment is utilized, contact reputable water treatment company familiar with the local water conditions. Any chemical water treatment used must be compatible with the stainless or galvanized construction of the unit. The pH of the water should be maintained between 7 and 8.8. In order to prevent "white rust", the galvanized steel in the unit may require routine passivation of the steel when operating in higher pH levels. Batch chemical feeding is not recommended because it does not afford the proper degree of control.

If acid cleaning is required, extreme caution must be exercised and only inhibited acids compatible with galvanized steel construction should be used.

Control of Biological Contamination

Water quality should be checked regularly for biological contamination. If biological contamination is detected, a more aggressive water treatment and mechanical cleaning program should be undertaken. The water treatment program should be performed by a qualified water treatment company and in accordance with relevant local legislation. It is important that all internal surfaces be kept clean of accumulated dirt and sludge. In addition, the drift eliminators should be maintained in good operating condition.

Note: The location of the cooling tower must be considered during the equipment layout stages of a project. It is important to prevent the discharge air (potential of biological contamination) from being introduced into the fresh air intakes of the building.

LSTE

APPLICATIONS

Structural Steel Support

The recommended method of support for the LSTE cooling tower is two structural "I" beams located under the outer flanges and running the entire length of the unit. Mounting holes 19 mm in diameter, are located at the bottom channels of the pan section to provide for bolting to the structural steel. Refer to certified drawings from the factory for bolt hole locations. See the drawing and chart below for unit dimensions.

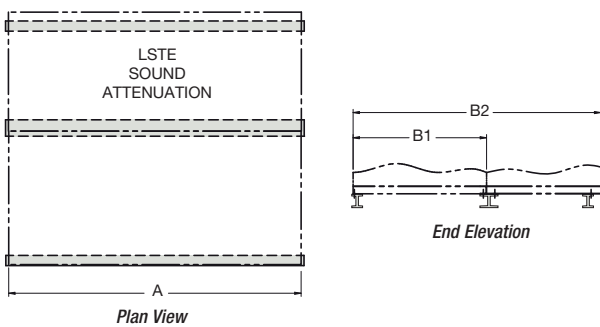

LSTE DIMENSIONS				
Unit No.	A (length)	B1(unit only)	B2*	
LSTE 416 to 466	1826	1235	3035	
419 to 439	2724	1235	3035	
4112 to 4612	3645	1235	3035	
4118 to 4518	5487	1235	3035	
5112 to 5512	3645	1651	3453	
5118 to 5718	5484	1651	3453	
8P112 to 8P512	3651	2388	4188	
8P118 to 8P618	5486	2388	4188	
8P124 to 8P524	7341	2388	4188	
8P136 to 8P536	11030	2388	4188	
10112 to 10612	3651	2991	4791	
10118 to 10718	5493	2991	4791	
10124 to 10524	7344	2991	4791	
10136 to 10636	11036	2991	4791	

* Units with intake attenuators

Note:

- 1) Beams should be level to within 1/360 of unit length, not to exceed 13 mm before setting the unit in place.
- 2) Do not level the unit by shimming between it and the "I" beams as this will not provide proper longitudinal support.
- 3) Beams should be sized in accordance with accepted structural practices. Support beams and anchor bolts are to be furnished by others.



Ultra Quiet Cooling Towers

The LSTE Cooling Tower is now available with sound attenuators to reduce the overall sound generated from the side or top of the Cooling Tower. Each option provides various levels of sound reduction and can be used in combination to provide the lowest sound level.



Cooling Tower Attenuation with CTI Performance Certification

SOUND

LSTE

DISCHARGE & INTAKE ATTENUATION DIMENSIONS

Sound Attenuation

The centrifugal fan design of the LSTE models operate at lower sound levels which make the units preferable for installations where noise is a concern. For extremely noise sensitive installations, the LSTE models may be supplied with inlet and/or discharge attenuation packages which greatly reduce the sound levels. Evapco offers Inlet and/or discharge attenuation packages with CTI Certified performance.



Discharge attenuation quiets sound radiating from the top of the unit and features a design with insulated walls acoustically lined with high density fiberglass.

Inlet attenuation reduces sound radiated through the tower air intakes and consists of acoustically lined baffles to capture radiated noise.

LSTE Discharge Attenuation Dimensions*

LSTE type	H1 (mm)	L1 (mm)	W1 (mm)	Weight per attenuator (kg)	Number of attenuators
4x6	1191	1826	1156	195	1
4x9	1191	2724	1156	259	1
4x12	1191	3645	1156	340	1
4x18	1191	5499	1156	467	1
5x12	1191	3645	1568	553	1
5x18	1192	5499	1594	757	1
8Px12	1813	3651	2419	1043	1
8Px18	1813	5499	2419	1420	1
8Px24	1813	3651	2419	1043	2
8Px36	1813	3651	2419	1043	3
3Mx12	1813	3645	3019	1234	1
3Mx18	1813	5499	3026	1674	1
3Mx24	1813	3645	3019	1234	2
3Mx36	1813	3645	3019	1234	3

LSTE Intake Attenuation Dimensions*

LSTE type	H2 (mm)	L2 (mm)	W2 (mm)	Weight per attenuator (kg)	Number of attenuators
4x6	1010	1921	1810	432	1
4x9	1010	2820	1810	594	1
4x12	1010	3740	1810	753	1
4x18	1010	5564	1810	1107	1
5x12	1168	3740	1813	753	1
5x18	1170	5564	1813	1093	1
8Px12	2070	3740	1813	1016	1
8Px18	2070	5582	1813	1456	1
8Px24	2070	3715	1813	1016	2
8Px36	2070	5559	1813	1456	2
3Mx12	2261	3740	1813	1057	1
3Mx18	2261	5582	1813	1515	1
3Mx24	2261	3718	1813	1057	2
3Mx36	2261	5559	1813	1515	2

*Attenuation dimensions may vary slightly from catalog. See factory certified prints for exact dimensions.

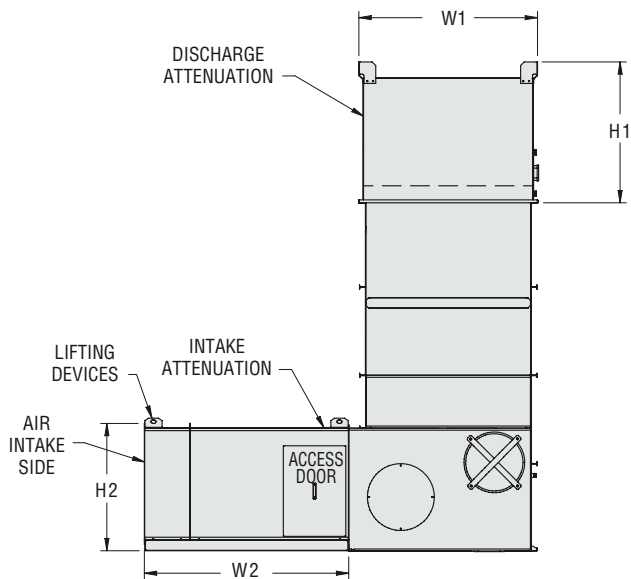
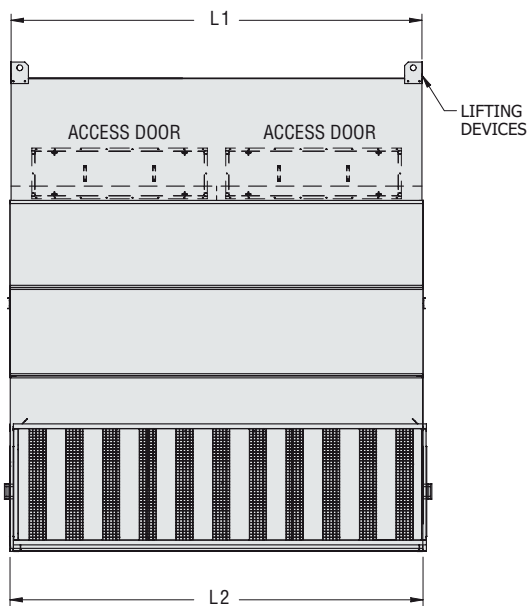

LSTE Attenuation

† Mark owned by the Cooling Technology Institute

We Stand Tall Through it All!



The International Building Code (IBC) is a comprehensive set of regulations addressing the structural design and installation requirements for building systems – including HVAC and industrial refrigeration equipment.



With the advent of the IBC, EVAPCO is proud to introduce the LSTE Cooling Towers with IBC 2009 compliance standard.



Wind, Rain, Earthquake and Hurricane

EVAPCO Cooling Towers... designed to withstand seismic or wind load forces.

LSTE

IBC COMPLIANCE

In its continuing commitment to be the leaders in evaporative cooling equipment design and services, EVAPCO LSTE Cooling Towers are now **Independently Certified** to withstand Seismic and Wind Loads in accordance with IBC 2009.

What is IBC?

International Building Code

The International Building Code (IBC) is a comprehensive set of regulations addressing both the structural design and the installation requirements for building systems – including HVAC and industrial refrigeration equipment. Compared to previous building codes that considered only the building structure and component anchorage, the requirements contained within the IBC address anchorage, structural integrity, and the operational capability of a component following either a seismic or wind load event. **Simply stated, the IBC code provisions require that evaporative cooling equipment, and all other components permanently installed on a structure, must be designed to meet the same seismic or wind load forces as the building to which they are attached.**

How Does IBC 2009 Apply to Cooling Towers?

Based on site design factors, calculations are made to determine the equivalent seismic “g force” and wind load (kilo-Newton per square meter, kN/m²) on the unit. The cooling tower must be designed to withstand the greater of either the seismic or wind load.

The New LSTE is offered with a choice of TWO structural design packages:

- **Standard Structural Design** – For projects with ≤1.0g seismic or 2,87 kN/m² wind loads
- **Upgraded Structural Design** – Required for projects with >1.0 g seismic or 6,94 kN/m² wind loads

All locations with design criteria resulting in a seismic design force of up to 1.0g or a wind load of 2,87 kN/m² or below will be provided with the standard LSTE structural design. An upgraded structural design is available for installations with design criteria resulting in “g forces” greater than 1.0g. The highest “g force” location in North America is 5.12g. The highest wind load shown on the maps is 273 km/h, which is approximately equal to 6,94 kN/m² velocity pressure. **Therefore, the upgraded structural design package option for the New LSTE is designed for 5.12 g and 6,94 kN/m² making it applicable to ALL building locations in North America.**

Design Implementation

EVAPCO applies the seismic design and wind load information provided for the project to determine the equipment design necessary to meet IBC requirements. This process ensures that the mechanical equipment and its components are compliant per the provisions of the IBC as given in the plans and specifications for the project.

Independent Certification

Although the IBC references and is based on the structural building code ASCE 7, many chapters and paragraphs of ASCE 7 are superseded by the IBC, independent certification and methods of analysis are such paragraphs. Per the most recent edition of the code, the EVAPCO compliance process included an exhaustive analysis by an independent approval agency. As required by the International Building Code, EVAPCO supplies a certificate of compliance as part of its submittal documents. The certificate of compliance demonstrates that the equipment has been independently tested and analyzed in accordance with the IBC seismic and wind load requirements. Evapco has worked closely with the independent approval agency, The VMC Group, to complete the independent equipment testing and analysis.

For further questions regarding IBC compliance, please contact your local EVAPCO Representative.





CTI-Eurovent Certified LSTE Cooling Towers

ECC-CTI

CTI Standard 201

This standard sets forth a program whereby the Cooling Technology Institute will certify that all models of a line of evaporative heat rejection equipment offered for sale by a specific manufacturer will perform thermally in accordance with the manufacturer's published ratings...



***Technology for the Future,
Available Today!***

† Mark owned by the Cooling Technology Institute

In its continuing commitment to be the leaders in evaporative cooling equipment design and services, EVAPCO LSTE Cooling Towers are now **Independently Certified** by **CTI**, to perform thermally in accordance with the published data.

What is CTI?

Cooling Technology Institute

The Cooling Technology Institute is an organization headquartered in the United States with over 400 member companies from around the globe. CTI membership is composed of manufacturers, suppliers, owner operators, and test agencies from over 40 countries. In 2008 CTI certified more than 5000 Evaporative Heat Transfer Systems (EHTS) from 49 product lines of 24 participants.

CTI's Mission and Objectives

This can be best explained by the CTI's published Mission statement and Objectives revised in December 2003 and published on their website www.cti.org.

CTI Mission Statement

To advocate and promote the use of environmentally responsible Evaporative Heat Transfer Systems (EHTS) for the benefit of the public by encouraging:

- Education
- Research
- Standards Development and Verification
- Government Relations
- Technical Information Exchange

CTI Objectives

- Maintain and expand a broad base membership of individuals and organizations interested in Evaporative Heat Transfer Systems (EHTS).
- Identify and address emerging and evolving issues concerning EHTS.
- Encourage and support educational programs in various formats to enhance the capabilities and competence of the industry to realize the maximum benefit of EHTS.
- Encourage and support cooperative research to improve EHTS technology and efficiency for the long-term benefit of the environment.
- Assure acceptable minimum quality levels and performance of EHTS and their components by establishing standard specifications, guidelines, and certification programs.
- Establish standard testing and performance analysis systems and procedures for EHTS.
- Communicate with and influence governmental entities regarding the environmentally responsible technologies, benefits, and issues associated with EHTS.
- Encourage and support forums and methods for exchanging technical information on EHTS.

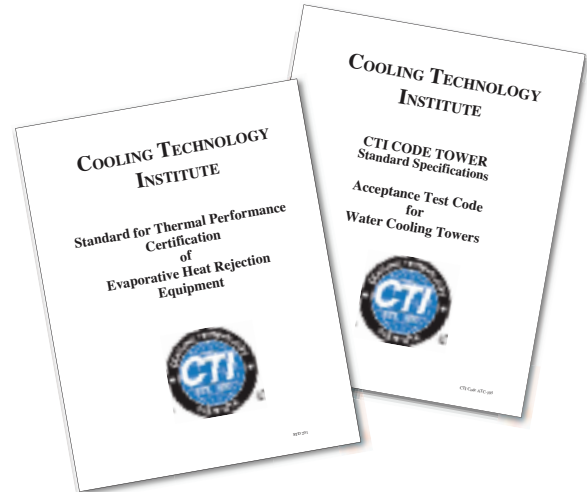

Benefits to the End User

CTI defines an independent testing certification program that is specifiable, enforceable and available to all equipment manufacturer's. End users that purchase CTI certified products are assured that those products will perform thermally as specified.

Additionally CTI certification is the first step for the Green Building Concept in Europe:

- LEED - Leadership in Energy and Environmental Design
- Best Available Practice
- Green Building Rating System

Thermal Performance Guarantee

In addition to the CTI Certification, Evapco unequivocally guarantees the Thermal Performance of ALL Evapco Equipment. Every unit order is confirmed with a submittal package that includes an Evapco Thermal Performance Guarantee Certificate.



CTI CERTIFICATION

CTI Certification Program

CTI Certification Process

- Submit Application for Certification
- CTI completes a technical review of the product line submitted
- CTI performs an initial qualification test in a laboratory on a specified model number
- CTI issues an Approval Letter with Validation Number if test is passed. Letter is also distributed to all members of CTI to inform everyone that a successful certification has been completed. The Certification Validation Number assigned should be fixed to each tower sold and displayed in all catalogs and other literature
- Product Line must undergo an Annual Reverification Test - Different model number is selected every year
- More details can be found on the CTI website www.cti.org

CTI Certification Test Parameters

- Entering Wet Bulb temperature - 12.8°C to 32.2°C
- Cooling Range - Minimum of 2.2°C
- Cooling Approach - Minimum of 2.8°C
- Process Fluid Temperature - Maximum of 51.7°C
- Barometric Pressure - 91.4 to 105 kPa
- More details can be found on the CTI website www.cti.org

CTI Certification Limitations

- Specific manufacturer's product line name and model numbers
- Applicable only to product lines and model numbers submitted
- Multiple cell model numbers are allowed if the airflow is not affected or the configuration impact is included in the unit rating
- Optional accessories are allowed if the airflow is not affected or the accessory impact is accounted for in the rating
- More details can be found on the CTI website www.cti.org

Evapco Europe CTI Certified LSTE Product Line

LSTE Line of CTI Certified Cooling Towers

- CTI Certification Validation Number 05-13-03
- Includes Intake attenuators and related motor changes
- Includes Discharge attenuators and related motor changes
- Includes Full sound attenuators and related motor changes
- Includes motor size changes
- Includes Tapered discharge hoods
- **evapSelect™** Technical data sheet will state "ECC-CTI Certified Cooling Tower"
- Unit will receive a CTI and ECC Certified Shield located near the nameplate

Note

All CTI Certified Product Lines of all manufacturers with CTI certified products can be found on the website: <http://www.cti.org/certification.shtml>



† Mark owned by the Cooling Technology Institute

In 2007 Evapco launched the initiative to create the "European Chapter" of CTI. At the start of this initiative, Eurovent and CTI established a "Memorandum of Understanding". Since then the "Operational Manual for Certification of Cooling Towers" and the "Eurovent Rating Standard for Cooling Towers" were written. Both documents are strongly tied to the CTI documents STD 201 and ATC 105. A common "Eurovent-CTI" Certification program has become the European Standard for independent thermal performance rating of cooling towers. All Evapco CTI Certified cooling towers will be Eurovent-CTI certified as from February 2012.

EUROVENT – CTI cooperation

EUROVENT Association

Initially founded in 1958 EUROVENT Association represents the European refrigeration, air conditioning, air handling, heating and ventilation industry and trade associations from European and non-European countries. Over 1000 companies in 13 European countries, employing 150000 employees who jointly generate more than €25 to 30 billion of annual output are member of this organization.



EUROVENT mission

EUROVENT represents, promotes and defends the industry to relevant national and international bodies and cooperates with other European umbrella associations. Over the years EUROVENT has become a well-known and respected stakeholder in all industry related matters and, in particular, in climate change and energy efficiency. EUROVENT develops product certification programs for the entire industry through the EUROVENT Certification Company.

EUROVENT Certification



The main objective of the EUROVENT Certification Company (ECC) is to certify cooling equipment (and/or components) independently from EUROVENT Association. With a common set of well-defined procedures and criteria for the rating of products, comparison of product performance ensures a healthy and solid competition on a market open to all manufacturers. When a manufacturer participates in a certification program, he has to present its list of models or model ranges together with their performance data. The files are evaluated by the ECC Certification and a predefined number of units are selected for testing by **independent laboratories**. If the results comply with the relevant standards, the submitted models or ranges will be listed in the **EUROVENT Certification Online Directory**. Models are subject to regular random testing to verify compliance with catalogue data.

Benefits

The Certification Mark guarantees specifying engineers, installers and end users that the products marketed by a participant have been submitted to independent testing and that they have been accurately rated. Through specification of **certified products**, the engineer's tasks become easier, since there is no need to carry out detailed comparison and performance testing.



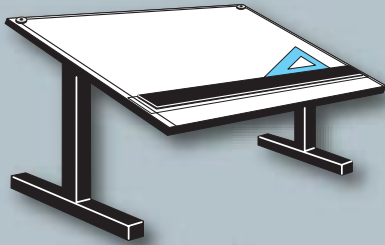

Thermal Performance



Engineering Data & Dimensions

LSTE

THERMAL PERFORMANCE

Thermal performance certified by the Cooling Technology Institute (CTI) and Eurovent Certification Company (ECC) in accordance with CTI Standard 201



Models LSTE 416 to 4518

To Make a Selection:

Locate the column with the desired operating temperature conditions. Read down the column until you find the l/s equal to or greater than the flow required. Read horizontally to the left to find the model number of the unit that will perform the duty.

MODEL NO.	MOTOR kW	Cooling Capacity in l/s										
		TEMP °C										
		EWT	32	36	32	36	32	36	32	37	35	40
		LWT	27	26	27	26	27	26	27	27	30	30
WB	19	19	20	20	21	21	22	22	24	24		
LSTE-416	1,5		9,6	5,3	8,8	4,8	7,7	4,3	6,8	4,5	9,2	5,9
LSTE-426	2,2		11,1	6,2	10,2	5,7	9,0	5,0	7,9	5,3	10,6	6,9
LSTE-436	4		13,2	7,5	12,3	6,9	10,8	6,1	9,6	6,4	12,7	8,4
LSTE-446	5,5		15,1	8,7	14,1	8,0	12,5	7,1	11,1	7,5	14,6	9,7
LSTE-456	5,5		16,4	9,8	15,3	9,1	13,7	8,1	12,2	8,5	15,8	10,8
LSTE-466	7,5		17,9	10,8	16,7	10,0	15,0	9,0	13,4	9,4	17,3	11,9
LSTE-419	5,5		20,0	11,3	18,6	10,4	16,4	9,2	14,5	9,6	19,2	12,6
LSTE-429	7,5		22,0	12,6	20,5	11,6	18,1	10,2	16,1	10,8	21,2	14,0
LSTE-439	7,5		23,9	14,3	22,3	13,2	19,9	11,8	17,8	12,4	23,0	15,7
LSTE-4112	7,5		26,9	15,2	25,0	14,0	22,0	12,3	19,5	13,0	25,9	17,0
LSTE-4212	7,5		29,4	17,4	27,4	16,1	24,4	14,4	21,8	15,0	28,3	19,2
LSTE-4312	7,5		30,6	18,7	28,6	17,4	25,7	15,6	23,1	16,3	29,6	20,5
LSTE-4412	11		33,3	20,0	31,2	18,5	27,8	16,5	24,9	17,3	32,2	22,0
LSTE-4512	11		34,6	21,3	32,4	19,8	29,1	17,9	26,2	18,6	33,5	23,3
LSTE-4612	15		37,8	23,3	35,4	21,7	31,8	19,6	28,6	20,4	36,5	25,5
LSTE-4118	15		44,8	25,7	41,7	23,6	37,0	20,9	32,8	22,0	43,2	28,6
LSTE-4218	15		48,7	29,1	45,5	26,9	40,6	24,0	36,3	25,2	47,0	32,1
LSTE-4318	18,5		52,2	31,4	48,8	29,1	43,6	26,0	39,1	27,2	50,4	34,6
LSTE-4418	18,5		54,2	33,4	50,7	31,1	45,5	28,0	41,0	29,2	52,4	36,5
LSTE-4518	22		57,3	35,4	53,6	32,9	48,2	29,7	43,4	31,0	55,3	38,6

MODEL NO.	MOTOR kW	Cooling Capacity in l/s										
		TEMP °C										
		EWT	35	40	35	37	40	42	36	37	41	42
		LWT	30	30	30	32	30	32	31	32	31	32
WB	25	25	26	26	26	26	27	27	27	27		
LSTE-416	1,5		8,2	5,4	6,9	10,0	4,6	6,5	7,3	9,0	4,9	5,9
LSTE-426	2,2		9,6	6,3	8,0	11,6	5,4	7,5	8,5	10,4	5,8	6,9
LSTE-436	4		11,5	8,4	9,7	13,8	6,6	9,1	10,3	12,5	7,0	8,4
LSTE-446	5,5		13,2	8,9	11,2	15,8	7,7	10,6	11,9	14,3	8,2	9,8
LSTE-456	5,5		14,4	10,0	12,4	17,1	8,7	11,7	13,0	15,5	9,2	10,9
LSTE-466	7,5		15,8	11,0	13,6	18,0	9,7	12,9	14,3	17,0	10,2	12,0
LSTE-419	5,5		17,3	11,5	14,7	20,9	9,9	13,8	15,5	18,9	10,6	12,7
LSTE-429	7,5		19,2	12,8	16,3	22,9	11,1	15,3	17,2	20,8	11,8	14,1
LSTE-439	7,5		21,0	14,5	18,0	24,9	12,7	17,1	18,9	22,6	13,4	15,8
LSTE-4112	7,5		23,3	15,5	19,8	28,1	13,4	18,6	20,8	25,4	14,2	17,1
LSTE-4212	7,5		25,7	17,7	22,1	30,6	15,4	20,9	23,2	27,8	16,3	19,3
LSTE-4312	7,5		27,0	19,0	23,3	31,9	16,8	22,2	24,4	29,1	17,7	20,6
LSTE-4412	11		29,3	20,3	25,2	34,7	17,8	23,9	26,5	31,6	18,8	22,1
LSTE-4512	11		30,6	21,6	26,5	36,1	19,1	25,2	27,7	32,9	20,1	23,4
LSTE-4612	15		33,4	23,7	29,0	--	20,9	27,5	30,3	35,9	22,0	25,6
LSTE-4118	15		39,1	26,2	33,2	46,8	22,6	31,3	35,0	42,4	24,0	28,8
LSTE-4218	15		42,8	29,6	36,8	50,7	25,9	34,8	38,6	46,2	27,3	32,2
LSTE-4318	18,5		45,9	31,9	39,6	54,4	27,9	37,5	41,5	49,5	29,5	34,7
LSTE-4418	18,5		47,8	33,9	41,5	56,4	29,9	39,4	43,4	51,5	31,5	36,7
LSTE-4518	22		50,6	35,9	43,9	--	31,7	41,7	45,9	54,4	33,4	38,8

Note: For alternate selections and conditions other than those stated, consult your **evapSelect** selection program or local EVAPCO representative.

† Mark Owned by the Cooling Technology Institute.

ENGINEERING DATA AND DIMENSIONS

LSTE

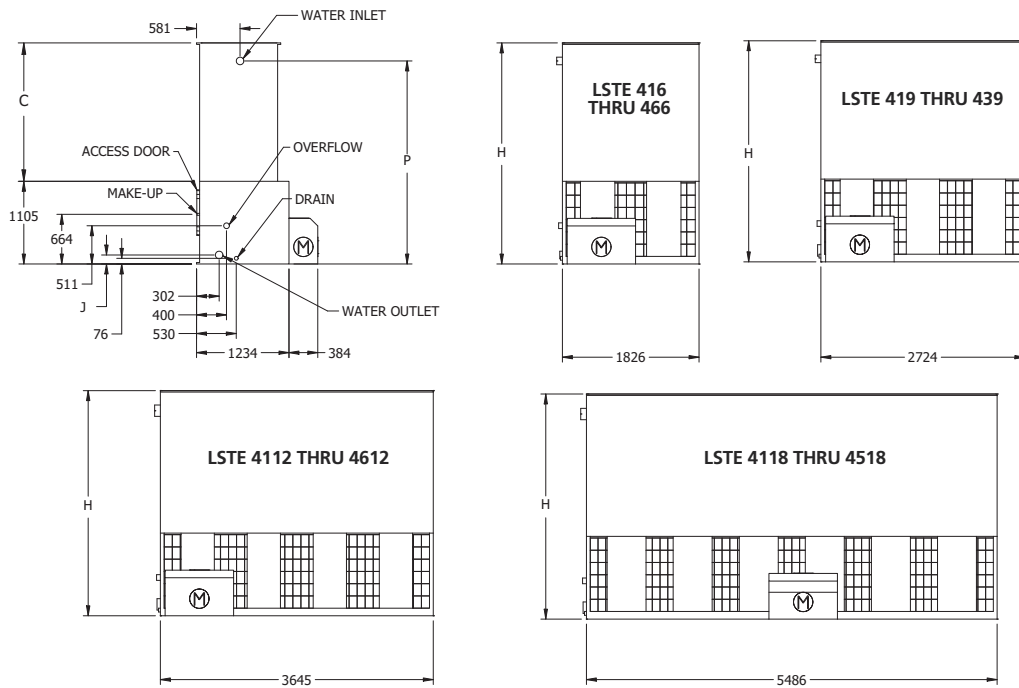

Small Centrifugal Fan Models

LSTE 416 to 4518

Model No.	Weight (kg)		No. Fans	Fan Motor kW*	Air Flow m ³ /s	Dimensions (mm)				Connections (mm)				
	Shipping	Operating				H	P	C	J	Water In	Water Out	Make Up	Drain	Over Flow
LSTE 416	745	1045	2	1,5	4,3	2648	2407	1543	121	100	100	25	50	80
LSTE 426	755	1055	2	2,2	4,9	2648	2407	1543	121	100	100	25	50	80
LSTE 436	760	1060	2	4	5,8	2648	2407	1543	121	100	100	25	50	80
LSTE 446	785	1085	2	5,5	6,5	2648	2407	1543	121	100	100	25	50	80
LSTE 456	815	1115	2	5,5	6,3	2953	2711	1848	121	100	100	25	50	80
LSTE 466	820	1120	2	7,5	6,9	2953	2711	1848	121	100	100	25	50	80
LSTE 419	1030	1490	3	5,5	8,7	2648	2407	1543	152	100	100	25	50	80
LSTE 429	1035	1495	3	7,5	9,4	2648	2407	1543	152	100	100	25	50	80
LSTE 439	1050	1510	3	7,5	9,2	2953	2711	1848	152	100	100	25	50	80
LSTE 4112	1330	1925	4	7,5	11,6	2702	2435	1597	152	150	150	25	50	80
LSTE 4212	1410	2005	4	7,5	11,3	3007	2740	1902	152	150	150	25	50	80
LSTE 4312	1495	2090	4	7,5	10,9	3312	3045	2207	152	150	150	25	50	80
LSTE 4412	1470	2065	4	11	12,7	3007	2740	1902	152	150	150	25	50	80
LSTE 4512	1555	2150	4	11	12,3	3312	3045	2207	152	150	150	25	50	80
LSTE 4612	1585	2175	4	15	13,5	3312	3045	2207	152	150	150	25	50	80
LSTE 4118	1965	2870	6	15	19,0	2702	2435	1597	152	150	150	25	50	80
LSTE 4218	2085	2995	6	15	18,6	3007	2740	1902	152	150	150	25	50	80
LSTE 4318	2100	3005	6	18,5	19,8	3007	2740	1902	152	150	150	25	50	80
LSTE 4418	2225	3135	6	18,5	19,2	3312	3045	2207	152	150	150	25	50	80
LSTE 4518	2250	3155	6	22	20,3	3312	3045	2207	152	150	150	25	50	80

NOTES:

1. An adequately sized bleed line must be installed in the cooling tower system to prevent build-up of impurities in the recirculated water.
 2. Connections 150 mm or smaller are MPT. Connections larger than 150 mm are Beveled For Welding. (BFW)
 3. Do not use catalog drawings for certified prints. Dimensions are subject to change.
- * For external static pressure up to 120 Pa, use next size fan motor.



LSTE

THERMAL PERFORMANCE

Thermal performance certified by the Cooling Technology Institute (CTI) and Eurovent Certification Company (ECC) in accordance with CTI Standard 201



Models LSTE 5112 to 5718

To Make a Selection:

Locate the column with the desired operating temperature conditions. Read down the column until you find the l/s equal to or greater than the flow required. Read horizontally to the left to find the model number of the unit that will perform the duty.

MODEL NO.	MOTOR kW	Cooling Capacity in l/s										
		TEMP °C										
		EWT	32	36	32	36	32	36	32	37	35	40
		LWT	27	26	27	26	27	26	27	27	30	30
WB	19	19	20	20	21	21	22	22	24	24		
LSTE 5112	(1) 15		43,8	25,2	40,6	23,0	36,7	20,7	32,4	21,8	42,2	28,0
LSTE 5212	(1) 15		47,7	28,6	44,3	26,3	40,3	23,8	35,9	25,0	46,0	31,5
LSTE 5312	(1) 18,5		50,9	30,7	47,4	28,3	43,2	25,7	38,6	26,9	49,2	33,8
LSTE 5412	(1) 18,5		52,9	32,6	49,3	30,2	45,0	27,6	40,4	28,8	51,1	35,6
LSTE 5512	(1) 22		55,9	34,5	52,1	32,0	47,6	29,3	42,7	30,5	54,0	37,7
LSTE 5118	(1) 18,5		62,2	35,4	57,6	32,4	51,9	29,1	45,7	30,6	59,9	39,5
LSTE 5218	(1) 22		66,0	38,0	61,2	34,7	55,3	31,2	48,8	32,8	63,7	42,2
LSTE 5318	(1) 30		72,4	42,3	67,3	38,7	61,0	34,8	54,1	36,6	69,9	46,9
LSTE 5418	(1) 22		71,7	42,9	66,7	39,5	60,6	35,8	54,0	37,6	69,2	47,3
LSTE 5518	(1) 30		78,4	47,3	72,9	43,6	66,5	39,6	59,4	41,5	75,7	52,1
LSTE 5618	(1) 30		81,3	50,1	75,8	46,5	69,3	42,5	62,1	44,4	78,6	54,8
LSTE 5718	(1) 37		--	53,8	81,1	49,9	74,1	45,7	66,5	47,6	84,1	58,8

MODEL NO.	MOTOR kW	Cooling Capacity in l/s										
		TEMP °C										
		EWT	35	40	35	37	40	42	36	37	41	42
		LWT	30	30	30	32	30	32	31	32	31	32
WB	25	25	26	26	26	26	27	27	27	27		
LSTE 5112	(1) 15		38,0	25,5	33,0	46,3	22,6	31,2	34,7	41,9	23,8	28,5
LSTE 5212	(1) 15		41,7	28,9	36,5	50,3	25,8	34,7	38,2	45,7	27,1	31,9
LSTE 5312	(1) 18,5		44,6	31,0	39,2	53,7	27,8	37,2	41,0	48,8	29,1	34,3
LSTE 5412	(1) 18,5		46,5	32,9	41,0	55,7	29,7	39,0	42,8	50,7	31,0	36,1
LSTE 5512	(1) 22		49,1	34,8	43,4	--	31,5	41,3	45,3	53,6	32,9	38,3
LSTE 5118	(1) 18,5		53,8	35,9	46,5	65,8	31,7	44,0	49,0	59,5	33,4	40,1
LSTE 5218	(1) 22		57,3	38,4	49,7	69,8	34,0	47,0	52,3	63,2	35,8	43,0
LSTE 5318	(1) 30		63,1	42,8	55,0	76,5	37,9	52,1	57,7	69,4	39,9	47,7
LSTE 5418	(1) 22		62,7	43,4	54,9	75,6	38,8	52,1	57,5	68,7	40,7	48,0
LSTE 5518	(1) 30		68,7	47,8	60,3	82,6	42,9	57,3	63,1	75,1	44,9	52,9
LSTE 5618	(1) 30		71,5	50,6	63,1	--	45,7	60,1	65,9	78,0	47,8	55,6
LSTE 5718	(1) 37		76,5	54,3	67,6	--	49,1	64,4	70,5	83,5	51,2	59,6

Note: For alternate selections and conditions other than those stated, consult your **evapSelect** selection program or local EVAPCO representative.

† Mark Owned by the Cooling Technology Institute.

ENGINEERING DATA AND DIMENSIONS

LSTE

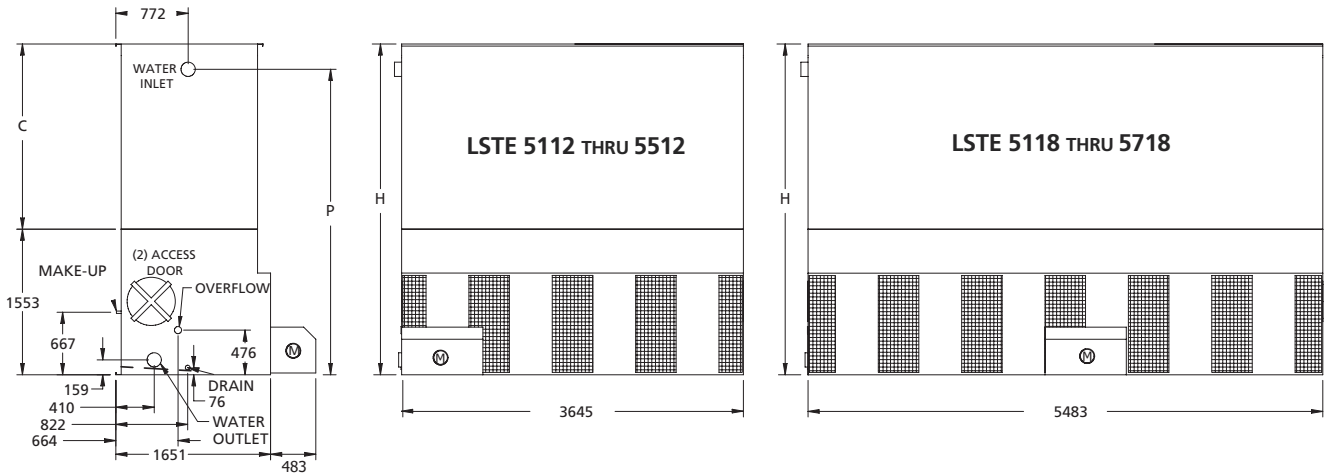

Small Centrifugal Fan Models

LSTE 5112 to 5718

Model No.	Weight (kg)		No. Fans	Fan Motor kW*	Air Flow m ³ /s	Dimensions (mm)			Connections (mm)				
	Shipping	Operating				H	P	C	Water In	Water Out	Make Up	Drain	Over Flow
LSTE 5112	1875	2835	4	15	18,3	3223	2953	1670	150	150	25	50	80
LSTE 5212	1980	2945	4	15	17,8	3527	3258	1975	150	150	25	50	80
LSTE 5312	1995	2955	4	18,5	19,1	3527	3258	1975	150	150	25	50	80
LSTE 5412	2105	3065	4	18,5	18,7	3832	3562	2280	150	150	25	50	80
LSTE 5512	2125	3090	4	22	19,8	3832	3562	2280	150	150	25	50	80
LSTE 5118	2710	4155	6	18,5	26,1	3223	2953	1670	150	150	50	50	80
LSTE 5218	2730	4180	6	22	27,6	3223	2953	1670	150	150	50	50	80
LSTE 5318	2805	4250	6	30	30,3	3223	2953	1670	150	150	50	50	80
LSTE 5418	2890	4335	6	22	26,9	3527	3258	1975	150	150	50	50	80
LSTE 5518	2960	4410	6	30	29,4	3527	3258	1975	150	150	50	50	80
LSTE 5618	3120	4570	6	30	28,7	3832	3562	2280	150	150	50	50	80
LSTE 5718	3125	4570	6	37	29,9	3832	3562	2280	150	150	50	50	80

NOTES:

1. An adequately sized bleed line must be installed in the cooling tower system to prevent build-up of impurities in the recirculated water.
2. Connections 150 mm or smaller are MPT. Connections larger than 150 mm are Beveled For Welding. (BFW)
3. Do not use catalog drawings for certified prints. Dimensions are subject to change.

* For external static pressure up to 120 Pa, use next size fan motor.



LSTE

THERMAL PERFORMANCE

Thermal performance certified by the Cooling Technology Institute (CTI) and Eurovent Certification Company (ECC) in accordance with CTI Standard 201



Models LSTE 8P112 to 8P536

To Make a Selection:

Locate the column with the desired operating temperature conditions. Read down the column until you find the l/s equal to or greater than the flow required. Read horizontally to the left to find the model number of the unit that will perform the duty.

MODEL NO.	MOTOR kW	Cooling Capacity in l/s										
		TEMP °C										
		EWT	32	36	32	36	32	36	32	37	35	40
		LWT	27	26	27	26	27	26	27	27	30	30
WB	19	19	20	20	21	21	22	22	24	24		
LSTE 8P112	(1) 22		66,0	37,7	61,1	34,4	55,2	30,9	48,6	32,5	63,6	41,9
LSTE 8P212	(1) 30		72,5	42,0	67,2	38,4	60,9	34,5	53,9	36,3	69,9	46,6
LSTE 8P312	(1) 30		78,5	47,2	73,1	43,5	66,5	39,5	59,3	41,3	75,8	52,0
LSTE 8P412	(1) 30		81,5	50,2	76,0	46,5	69,4	42,5	62,2	44,4	78,8	54,9
LSTE 8P512	(1) 37		87,2	53,8	81,3	50,0	74,3	45,7	66,7	47,7	84,3	58,9
LSTE 8P118	(1) 30		95,7	54,3	88,5	49,6	79,7	44,5	70,2	46,9	92,2	60,5
LSTE 8P218	(1) 37		103,0	59,1	95,5	54,0	86,3	48,5	76,1	51,1	99,3	65,8
LSTE 8P318	(1) 30		104,3	61,9	96,9	57,0	88,0	51,6	78,2	54,1	100,7	68,3
LSTE 8P418	(1) 37		111,9	66,9	104,0	61,6	94,6	55,8	84,3	58,5	108,0	73,7
LSTE 8P518	(1) 45		118,4	71,2	110,2	65,6	100,3	59,5	89,5	62,3	114,4	78,4
LSTE 8P618	(1) 45		123,0	75,7	114,7	70,2	104,7	64,1	93,8	66,9	118,9	82,8
LSTE 8P124	(2) 18,5		135,5	80,3	125,8	73,9	114,3	67,0	101,6	70,2	130,8	88,7
LSTE 8P224	(2) 30		145,0	84,0	134,5	76,8	121,9	69,0	107,7	72,6	139,8	93,3
LSTE 8P324	(2) 30		157,0	94,4	146,1	87,0	133,1	79,0	118,7	82,7	151,7	103,9
LSTE 8P424	(2) 30		163,1	100,4	152,0	93,1	138,9	85,0	124,5	88,8	157,7	109,8
LSTE 8P524	(2) 37		174,4	107,7	162,7	100,0	148,7	91,4	133,4	95,3	168,7	117,7
LSTE 8P136	(3) 22		198,1	113,1	183,4	103,3	165,5	92,7	145,8	97,6	190,8	125,8
LSTE 8P236	(3) 30		217,5	125,9	201,7	115,2	182,8	103,5	161,6	108,9	209,8	139,9
LSTE 8P336	(3) 30		235,5	141,6	219,2	130,6	199,6	118,4	178,0	124,0	227,5	155,9
LSTE 8P436	(3) 30		244,6	150,6	228,1	139,6	208,3	127,5	186,7	133,2	236,5	164,7
LSTE 8P536	(3) 37		261,7	161,5	244,0	149,9	223,0	137,0	200,1	143,0	253,0	176,6

MODEL NO.	MOTOR kW	Cooling Capacity in l/s										
		TEMP °C										
		EWT	35	40	35	37	40	42	36	37	41	42
		LWT	30	30	30	32	30	32	31	32	31	32
WB	25	25	26	26	26	26	27	27	27	27		
LSTE 8P112	(1) 22		57,2	38,1	49,5	69,8	33,8	46,7	52,0	63,1	35,5	42,7
LSTE 8P212	(1) 30		63,0	42,5	54,8	76,6	37,6	51,8	57,6	69,4	39,6	47,4
LSTE 8P312	(1) 30		68,7	47,7	60,3	82,8	42,7	57,3	63,1	75,3	44,8	52,8
LSTE 8P412	(1) 30		71,6	50,7	63,2	85,9	45,8	60,2	66,0	78,3	47,8	55,7
LSTE 8P512	(1) 37		76,7	54,4	67,7	--	49,1	64,5	70,7	83,7	51,3	59,7
LSTE 8P118	(1) 30		82,7	55,0	71,4	101,4	48,6	67,5	75,2	91,5	51,3	61,6
LSTE 8P218	(1) 37		89,4	59,8	77,4	109,0	52,9	73,2	81,4	98,5	55,8	66,9
LSTE 8P318	(1) 30		91,0	62,6	79,5	110,1	55,9	75,5	83,4	99,9	58,7	69,4
LSTE 8P418	(1) 37		97,8	67,6	85,7	118,1	60,5	81,3	89,7	107,2	63,4	74,9
LSTE 8P518	(1) 45		103,6	71,9	90,9	124,9	64,4	86,4	95,2	113,5	67,6	79,6
LSTE 8P618	(1) 45		108,1	76,5	95,3	129,6	69,0	90,7	99,5	118,0	72,1	84,0
LSTE 8P124	(2) 18,5		118,1	81,2	103,2	143,1	72,5	97,9	108,2	129,8	76,1	90,1
LSTE 8P224	(2) 30		126,1	85,0	109,7	153,2	75,3	103,7	115,1	138,7	79,3	94,8
LSTE 8P324	(2) 30		137,4	95,4	120,6	165,6	85,4	114,5	126,2	150,5	89,6	105,5
LSTE 8P424	(2) 30		143,3	101,4	126,4	171,8	91,5	120,3	132,0	156,5	95,6	111,4
LSTE 8P524	(2) 37		153,4	108,8	135,4	--	98,3	129,0	141,4	167,4	102,6	119,4
LSTE 8P136	(3) 22		171,5	114,4	148,4	209,5	101,3	140,2	156,0	189,3	106,6	128,0
LSTE 8P236	(3) 30		189,1	127,4	164,5	229,8	112,9	155,5	172,7	208,1	118,9	142,2
LSTE 8P336	(3) 30		206,1	143,1	180,9	248,4	128,2	171,8	189,3	225,8	134,4	158,3
LSTE 8P436	(3) 30		214,9	152,1	189,5	257,7	137,3	180,5	198,0	234,8	143,4	167,1
LSTE 8P536	(3) 37		230,1	163,2	203,1	--	147,4	193,5	212,1	251,1	153,9	179,2

Note: For alternate selections and conditions other than those stated, consult your evapSelect selection program or local EVAPCO representative.

† Mark Owned by the Cooling Technology Institute.

ENGINEERING DATA AND DIMENSIONS

LSTE

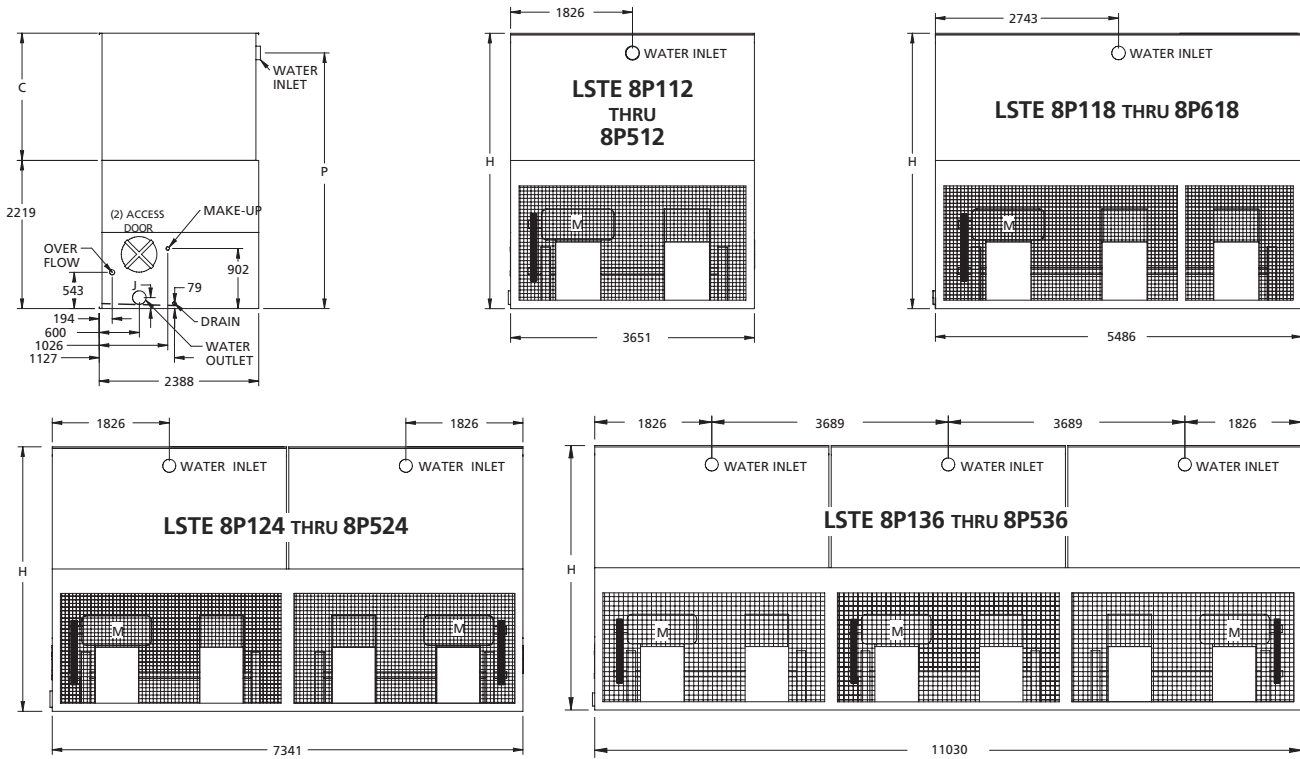

Large Centrifugal Fan Models

LSTE 8P112 to 8P536

Model No.	Weight (kg)		No. Fans	Fan Motor kW*	Air Flow m ³ /s	Dimensions (mm)				Connections (mm)				
	Shipping	Operating				H	P	C	J	Water In	Water Out	Make Up	Drain	Over Flow
LSTE 8P112	2512	4095	2	22	27,6	3820	3524	1600	178	200	200	50	50	80
LSTE 8P212	2590	4170	2	30	30,2	3820	3524	1600	178	200	200	50	50	80
LSTE 8P312	2745	4325	2	30	29,4	4124	3829	1905	178	200	200	50	50	80
LSTE 8P412	2895	4470	2	30	28,4	4429	4134	2210	178	200	200	50	50	80
LSTE 8P512	2900	4475	2	37	30,4	4429	4134	2210	178	200	200	50	50	80
LSTE 8P118	3710	6135	3	30	40,1	3820	3524	1600	178	200	200	50	50	80
LSTE 8P218	3715	6140	3	37	42,9	3820	3524	1600	178	200	200	50	50	80
LSTE 8P318	3725	6150	3	30	39,0	4124	3829	1905	178	200	200	50	50	80
LSTE 8P418	3730	6155	3	37	41,8	4124	3829	1905	178	200	200	50	50	80
LSTE 8P518	3830	6255	3	45	44,2	4124	3829	1905	178	200	200	50	50	80
LSTE 8P618	4255	6680	3	45	42,8	4429	4134	2210	178	200	200	50	50	80
LSTE 8P124	5205	8465	4	(2) 18.5	50,8	4124	3829	1905	200	(2) 200	250	50	50	80
LSTE 8P224	5085	8345	4	(2) 30	60,2	3820	3524	1600	200	(2) 200	250	50	50	80
LSTE 8P324	5395	8655	4	(2) 30	58,7	4124	3829	1905	200	(2) 200	250	50	50	80
LSTE 8P424	5695	8955	4	(2) 30	56,7	4429	4134	2210	200	(2) 200	250	50	50	80
LSTE 8P524	5700	8965	4	(2) 37	60,7	4429	4134	2210	200	(2) 200	250	50	50	80
LSTE 8P136	7580	12355	6	(3) 22	82,7	3820	3524	1600	178	(3) 200	(2) 200	(2) 50	(2) 50	(2) 80
LSTE 8P236	7795	12575	6	(3) 30	90,3	3820	3524	1600	178	(3) 200	(2) 200	(2) 50	(2) 50	(2) 80
LSTE 8P336	8260	13035	6	(3) 30	88,0	4124	3829	1905	178	(3) 200	(2) 200	(2) 50	(2) 50	(2) 80
LSTE 8P436	8710	13485	6	(3) 30	85,1	4429	4134	2210	178	(3) 200	(2) 200	(2) 50	(2) 50	(2) 80
LSTE 8P536	8725	13500	6	(3) 45	91,1	4429	4134	2210	178	(3) 200	(2) 200	(2) 50	(2) 50	(2) 80

NOTES:

1. An adequately sized bleed line must be installed in the cooling tower system to prevent build-up of impurities in the recirculated water.
 2. Connections 150 mm or smaller are MPT. Connections larger than 150 mm are Beveled For Welding. (BFW)
 3. Do not use catalog drawings for certified prints. Dimensions are subject to change.
- * For external static pressure up to 120 Pa, use next size fan motor.

LSTE

THERMAL PERFORMANCE

Thermal performance certified by the Cooling Technology Institute (CTI) and Eurovent Certification Company (ECC) in accordance with CTI Standard 201



Models LSTE 10112 to 10636

To Make a Selection:

Locate the column with the desired operating temperature conditions. Read down the column until you find the l/s equal to or greater than the flow required. Read horizontally to the left to find the model number of the unit that will perform the duty.

MODEL NO.	MOTOR kW	Cooling Capacity in l/s										
		TEMP °C										
		EWT	32	36	32	36	32	36	32	37	35	40
		LWT	27	26	27	26	27	26	27	27	30	30
WB	19	19	20	20	21	21	22	22	24	24		
LSTE 10112	(1) 22	87,1	51,7	80,9	47,6	73,5	43,1	65,3	45,2	84,1	57,1	
LSTE 10212	(1) 30	95,3	57,1	88,7	52,6	80,7	47,7	71,9	50,0	92,1	62,9	
LSTE 10312	(1) 30	99,1	60,9	92,4	56,4	84,3	51,5	75,6	53,8	95,8	66,6	
LSTE 10412	(1) 37	102,2	61,6	95,1	56,8	86,6	51,5	77,4	54,0	98,7	67,8	
LSTE 10512	(1) 37	106,1	65,4	98,9	60,6	90,3	55,4	81,0	57,8	102,5	71,5	
LSTE 10612	(1) 45	112,1	69,2	104,5	64,2	95,5	58,7	85,7	61,3	108,3	75,7	
LSTE 10118	(2) 18,5	121,3	68,8	112,2	62,9	101,1	56,4	89,0	59,4	116,9	76,7	
LSTE 10218	(2) 22	128,9	73,8	119,4	67,4	107,8	60,5	95,0	63,7	124,2	82,1	
LSTE 10318	(2) 18,5	132,3	78,5	122,8	72,3	111,6	65,5	99,2	68,6	127,7	86,6	
LSTE 10418	(2) 22	140,1	83,6	130,2	77,0	118,4	69,8	105,4	73,1	135,2	92,2	
LSTE 10518	(2) 22	145,7	89,4	135,8	82,8	123,9	75,6	111,0	78,9	140,9	97,9	
LSTE 10618	(2) 30	153,2	92,2	142,5	85,1	129,8	77,2	115,9	80,8	148,0	101,5	
LSTE 10718	(2) 30	159,0	98,0	148,3	90,8	135,4	83,0	121,4	86,6	153,7	107,1	
LSTE 10124	(2) 30	175,7	101,0	162,8	92,3	147,2	83,0	129,9	87,3	169,5	112,4	
LSTE 10224	(2) 30	190,7	114,2	177,3	105,2	161,3	95,4	143,8	99,9	184,2	125,8	
LSTE 10324	(2) 37	204,4	123,2	190,2	113,6	173,3	103,1	154,7	107,9	197,4	135,5	
LSTE 10424	(2) 37	212,1	130,7	197,8	121,2	180,7	110,8	162,0	115,6	205,1	142,9	
LSTE 10524	(2) 45	224,1	138,4	209,0	128,5	191,0	117,4	171,4	122,5	216,7	151,3	
LSTE 10136	(3) 30	263,6	151,6	244,2	138,5	220,9	124,5	194,9	130,9	254,2	168,6	
LSTE 10236	(3) 30	286,0	171,3	266,0	157,7	242,0	143,0	215,7	149,9	276,3	188,7	
LSTE 10336	(3) 37	306,5	184,7	285,3	170,4	259,9	154,6	232,1	161,9	296,1	203,3	
LSTE 10436	(3) 37	318,2	196,1	296,7	181,8	271,0	166,2	243,0	173,4	307,6	214,4	
LSTE 10536	(3) 45	336,2	207,6	313,5	192,7	286,5	176,2	257,1	183,8	325,0	227,0	
LSTE 10636	(3) 55	--	222,6	335,3	206,6	306,6	189,2	275,3	197,2	--	243,3	

MODEL NO.	MOTOR kW	Cooling Capacity in l/s										
		TEMP °C										
		EWT	35	40	35	37	40	42	36	37	41	42
		LWT	30	30	30	32	30	32	31	32	31	32
WB	25	25	26	26	26	26	27	27	27	27		
LSTE 10112	(1) 22	76,0	52,3	66,4	92,0	46,7	63,0	69,6	83,4	49,0	57,9	
LSTE 10212	(1) 30	83,4	57,7	73,0	100,6	51,6	69,4	76,5	91,4	54,1	63,9	
LSTE 10312	(1) 30	87,0	61,5	76,7	104,5	55,5	73,0	80,1	95,1	58,0	67,6	
LSTE 10412	(1) 37	89,5	62,2	78,6	107,8	55,8	74,7	82,2	98,0	58,4	68,8	
LSTE 10512	(1) 37	93,2	66,0	82,2	111,7	59,6	78,3	85,9	101,8	62,3	72,5	
LSTE 10612	(1) 45	98,5	69,9	87,0	--	63,2	82,9	90,8	107,5	65,9	76,8	
LSTE 10118	(2) 18,5	104,8	69,7	90,5	128,5	61,6	85,6	95,3	115,9	65,0	78,0	
LSTE 10218	(2) 22	111,7	74,7	96,7	136,4	66,0	91,4	101,7	123,2	69,6	83,5	
LSTE 10318	(2) 18,5	115,4	79,4	100,8	139,7	70,9	95,7	105,7	126,7	74,4	88,0	
LSTE 10418	(2) 22	122,4	84,6	107,2	147,8	75,6	101,7	112,2	134,2	79,3	93,6	
LSTE 10518	(2) 22	127,9	90,3	112,7	153,6	81,4	107,3	117,7	139,8	85,1	99,3	
LSTE 10618	(2) 30	134,1	93,2	117,7	161,6	83,5	111,8	123,2	146,8	87,5	103,1	
LSTE 10718	(2) 30	139,7	98,9	123,2	167,5	89,3	117,4	128,7	152,6	93,3	108,7	
LSTE 10124	(2) 30	152,5	102,2	132,2	185,8	90,5	125,0	139,1	168,1	95,3	114,3	
LSTE 10224	(2) 30	166,7	115,4	146,1	201,2	103,2	138,7	153,0	182,8	108,3	127,8	
LSTE 10324	(2) 37	179,0	124,5	157,1	215,5	111,5	149,3	164,4	195,9	116,9	137,6	
LSTE 10424	(2) 37	186,4	132,0	164,4	223,5	119,2	156,6	171,8	203,6	124,5	145,0	
LSTE 10524	(2) 45	197,0	139,8	174,0	--	126,3	165,7	181,7	215,1	131,9	153,5	
LSTE 10136	(3) 30	228,8	153,3	198,3	278,7	135,7	187,5	208,6	252,1	143,0	171,5	
LSTE 10236	(3) 30	250,1	173,1	219,1	301,8	154,8	208,1	229,5	274,2	162,4	191,6	
LSTE 10336	(3) 37	268,4	186,7	235,7	323,3	167,3	224,0	246,6	293,9	175,3	206,5	
LSTE 10436	(3) 37	279,6	198,0	246,7	335,2	178,7	234,9	257,6	305,4	186,8	217,5	
LSTE 10536	(3) 45	295,6	209,7	261,0	--	189,5	248,6	272,5	322,6	197,8	230,3	
LSTE 10636	(3) 55	316,2	224,8	279,5	--	203,2	266,3	291,7	--	212,2	246,8	

Note: For alternate selections and conditions other than those stated, consult your **evapSelect** selection program or local EVAPCO representative.

† Mark Owned by the Cooling Technology Institute.

ENGINEERING DATA AND DIMENSIONS

LSTE

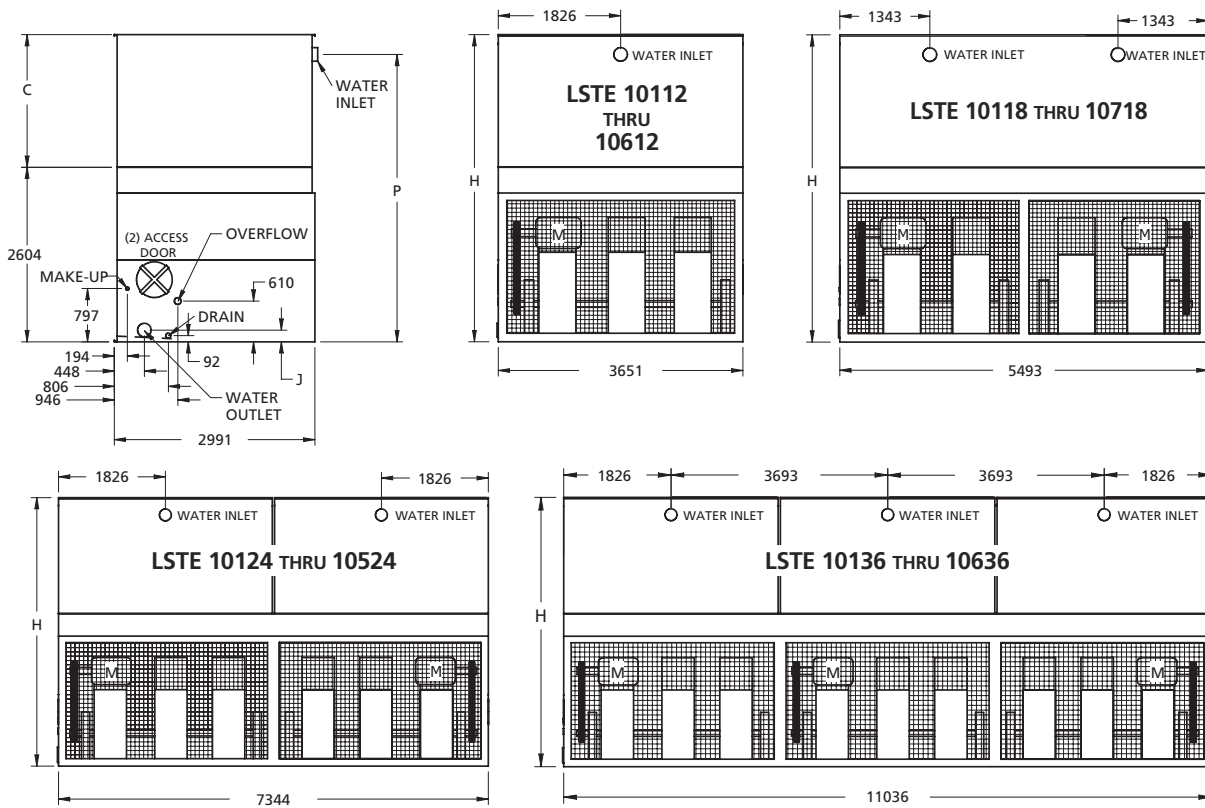

Large Centrifugal Fan Models

LSTE 10112 to 10636

Model No.	Weight (kg)		No. Fans	Fan Motor kW*	Air Flow m³/s	Dimensions (mm)				Connections (mm)				
	Shipping	Operating				H	P	C	J	Water In	Water Out	Make Up	Drain	Over Flow
LSTE 10112	3640	6325	3	22	32,6	4582	4286	1978	184	200	200	50	80	100
LSTE 10212	3715	6395	3	30	35,7	4582	4286	1978	184	200	200	50	80	100
LSTE 10312	3900	6580	3	30	34,9	4886	4591	2283	184	200	200	50	80	100
LSTE 10412	3720	6400	3	37	38,3	4582	4286	1978	184	200	200	50	80	100
LSTE 10512	3905	6585	3	37	37,4	4886	4591	2283	184	200	200	50	80	100
LSTE 10612	4005	6685	3	45	39,6	4886	4591	2283	184	200	200	50	80	100
LSTE 10118	5200	9260	4	(2) 18.5	52,2	4277	3981	1673	206	(2) 200	250	50	80	100
LSTE 10218	5245	9310	4	(2) 22	55,3	4277	3981	1673	206	(2) 200	250	50	80	100
LSTE 10318	5480	9545	4	(2) 18.5	50,8	4582	4286	1978	206	(2) 200	250	50	80	100
LSTE 10418	5525	9590	4	(2) 22	53,8	4582	4286	1978	206	(2) 200	250	50	80	100
LSTE 10518	5810	9875	4	(2) 22	52,6	4886	4591	2283	206	(2) 200	250	50	80	100
LSTE 10618	5670	9735	4	(2) 30	58,9	4582	4286	1978	206	(2) 200	250	50	80	100
LSTE 10718	5955	10020	4	(2) 30	57,6	4886	4591	2283	206	(2) 200	250	50	80	100
LSTE 10124	6905	12430	6	(2) 30	73,3	4277	3981	1673	206	(2) 200	250	50	80	100
LSTE 10224	7275	12800	6	(2) 30	71,4	4582	4286	1978	206	(2) 200	250	50	80	100
LSTE 10324	7285	12810	6	(2) 37	76,5	4582	4286	1978	206	(2) 200	250	50	80	100
LSTE 10424	7655	13180	6	(2) 37	74,8	4886	4591	2283	206	(2) 200	250	50	80	100
LSTE 10524	7850	13375	6	(2) 45	77,3	4886	4591	2283	206	(2) 200	250	50	80	100
LSTE 10136	10830	18705	9	(3) 30	110,1	4277	3981	1673	206	(3) 200	(2) 250	80	80	100
LSTE 10236	11390	19265	9	(3) 30	107,1	4582	4286	1978	206	(3) 200	(2) 250	80	80	100
LSTE 10336	11405	19280	9	(3) 37	114,7	4582	4286	1978	206	(3) 200	(2) 250	80	80	100
LSTE 10436	11960	19835	9	(3) 37	112,2	4886	4591	2283	206	(3) 200	(2) 250	80	80	100
LSTE 10536	12255	20130	9	(3) 45	118,9	4886	4591	2283	206	(3) 200	(2) 250	80	80	100
LSTE 10636	12390	20265	9	(3) 55	127,0	4886	4591	2283	206	(3) 200	(2) 250	80	80	100

NOTES:

1. An adequately sized bleed line must be installed in the cooling tower system to prevent build-up of impurities in the recirculated water.
2. Connections 150 mm or smaller are MPT. Connections larger than 150 mm are Beveled For Welding. (BFW)
3. Do not use catalog drawings for certified prints. Dimensions are subject to change.

* For external static pressure up to 120 Pa, use next size fan motor.



LSTE

SPECIFICATIONS

1.0 FORCED DRAFT LPT COOLING TOWER

1.1 General

Furnish and install factory assembled cooling tower of blow through, counterflow design with a horizontal single air side entry and a vertical air discharge. The unit shall be completely factory assembled and be conform to the specifications and schedules.

The total fan power should not exceed ____ kW and the total overall unit dimensions should not exceed the following:

Length: mm
Width: mm
Height: mm

The unit will be delivered in two parts: the section (pan-fan) and the top section (heat transfer).

The unit (top and bottom section) shall be joined together with elastic sealer and bolted together with corrosion resistant fasteners.

Approved manufacturer: Evapco – model LSTE_____

1.2 Thermal Performance – Performance Warranty

The tower shall be capable of performing the thermal duties as shown in the schedule and on the drawings, and its design thermal rating shall be certified by the Cooling Technology Institute (C.T.I.) and the Eurovent Certification Company (ECC). Only models with performance certified by CTI and ECC will be approved.

Manufacturers' performance guarantee without CTI-ECC certification for the proposed model or an independent field performance test shall not be accepted.

1.3 Applicable Standards

- ATC 128 Test Code for Measurement of Sound from Water Cooling Towers
- CTI STD 201 Standard for Thermal Performance Certification of Evaporative Heat Rejection Equipment
- Eurovent Rating Standard for Cooling Towers

1.4 Submittals

- The manufacturer shall submit a five year history of the proposed type of cooling tower with a minimum of 10 installations for similar sized equipment.
- Shop drawings: submit shop drawings indicating dimensions, weight loadings and required clearances.
- Product data: submit manufacturer's technical product data, original selection printouts and clearance requirements.
- Performance data: submit curves showing certified and guaranteed cooling tower performance with variation in outdoor air wet bulb temperature at design air flow and design flow rate.
In addition submit performance curves for 90% and 110% of design water flow rate, indicating the cooling tower temperatures versus the ambient air wet bulb temperatures.
- Complete noise data sheet for the selected cooling tower.
- Maintenance data for the cooling tower and accessories.
- The cooling tower manufacturer shall provide factory test run certificates of the fans and fan motor.

1.5 Product Delivery – Storage and Handling

- The contractor shall make the provisions for proper storage at site before installation and handle the product per the instructions of the manufacturer.
- Once installed provide the necessary measures that the units remain clean and protected from any dust and mechanical damage.

1.6 Quality Assurance

- The manufacturer shall have a quality assurance system in place which is certified by an accredited registrar and complying with the requirements of ISO 9001:2008.

This is to guarantee a consistent level of product and service quality.

- Manufacturers without ISO 9001:2008 certification are not acceptable.

1.7 Warranty

- The products will be warranted for a period of minimum two years from the date of shipment.

2.0 PRODUCT

2.1 Construction – Corrosion Resistance

STANDARD EXECUTION – GALVANIZED STEEL Z-725

- The structure and all steel elements of the pan and casing shall be constructed of Z-725 hot dip galvanized steel for long life and durability. Alternatives with lower zinc layer thickness and external paint or coating are not accepted as equal.
- The strainer shall be made of stainless steel type 304L.
- During fabrication all panel edges shall be coated with a 95% pure zinc compound.
- Casing materials shall be of non flammable construction.

OPTIONAL EXECUTION – BASIN IN SST 304L

- The structure and all steel elements of the Basin and Louver section up to the water level shall be made of SST 304L.
- Alternatives with hot dip galvanized steel and epoxy coatings in lieu of the SST 304L are not considered to be equal and are not accepted.
- All other steel components of the casing shall be constructed of Z-725 hot dip galvanized steel for long life and durability. Alternatives with lower zinc layer thickness and external paint or coating are not accepted as equal.
- The strainer shall be made of stainless steel type 304L.
- During fabrication all galvanized steel panel edges shall be coated with a 95% pure zinc compound.
- Casing materials shall be of non flammable construction.

UAT EXECUTION – Complete Unit SST 304L (except moving parts)

- The structure and all steel elements shall be made of SST 304L.
- Alternatives with hot dip galvanized steel and epoxy coatings in lieu of the SST 304L are not considered equal and accepted.
- Casing materials shall be of non flammable construction.

2.2 Construction – Seismic and wind load resistance

- The structural design must withstand 1g seismic or 2.87 kN/m² wind loads.
- Cooling Towers must be independently certified according to IBC 2009.

2.3 Pan / Fan section

- The heat transfer section shall be removable from the pan to provide easy handling and rigging.
- The pan – fan section shall include fans and drives mounted and aligned in the factory. These items shall be located in the dry air stream.
- Standard pan accessories shall included circular access doors, strainer(s) of anti vortex design, brass make up valve with unsinkable, foam filled plastic float arranged for easy adjustment.
- The basin bottom shall be sloped to provide drainage of the complete basin section.

2.4 Mechanical Equipment

2.4.1 Fan(s)

- Fans shall be dynamically balanced forwardly curved centrifugal type fans.

SPECIFICATIONS

- b) Fan housings shall have curved inlet rings for efficient air entry and rectangular discharge cowls which extend into the basin to increase fan efficiency and to prevent water from splashing into the fans.
- c) Curved inlet rings shall be made of the same material as the cooling tower.
- d) All fans will undergo a dry running test in the factory after being installed in the cooling tower basin.
- e) The fans will be mounted on either a solid or a hollow shaft with forged bearing journals.
- f) Easy to remove fan screens shall be provided to avoid direct contact with the moving parts.

2.4.2 Bearings and Drive

- a) The fan shaft(s) shall be supported by heavy duty, self aligning pillow block bearings with cast iron housings and lubrication fittings for maintenance.
- b) The fan drives shall be V belt type with taper lock sheaves designed for 150% of the motor nameplate horsepower.
- c) The bearings shall be rated for an L-10 life of 75,000 to 135,000 hours.

2.4.3 Motor

- a) The fan motor shall be Totally Enclosed, Fan Cooled (TEFC), squirrel cage, ball bearing type motor.
- b) The motor shall be minimum IP 55 degree of protection, Class F insulation, Service Factor 1 and selected for the appropriate cooling tower duty and the correct ambient temperature but minimum 40°C.
- c) Motor bearings shall be greased for life or external grease lines shall be provided.
- d) The motor shall be mounted on an adjustable heavy duty steel motor base.
- e) The motor selection shall be selected for the appropriate external static pressure.
- f) The motor power supply shall be ____ volts, ____ Hertz and ____ Phase.

2.5. Casing Section

2.5.1 Heat Transfer

- a) The cooling tower fill shall be PVC (Polyvinyl Chloride) of cross fluted design for optimum heat transfer and efficiency.
- b) The cross fluted sheets shall be bonded together for maximum strength and durability. Fill packs which are not bonded are not allowed.
- c) The PVC fill shall be self extinguishing for fire resistance with a flame spread rating of 5 per ASTM-E-84-81a.
- d) The fill shall be resistant to rot, decay or biological attack.
- e) The fill shall be able to withstand a water temperature of 55°C. The fill sheets will be bonded together in such a way that the structural integrity of the fill makes the fill useable as a working platform.
- f) The cooling tower manufacturer shall be responsible for the manufacturing and performance testing of the fill. This is to assure single source responsibility.

2.5.2 Water Distribution

- a) The spray header and branches shall be constructed of Schedule 40, Polyvinyl Chloride (PVC) pipe for corrosion resistance and shall have a steel connection to attach the external piping.
- b) The internal tower water distribution piping shall be easily removable for cleaning purposes.
- c) The branches have threaded end caps to assist with debris removal.
- d) The water shall be distributed over the fill by precision molded ABS spray nozzles with large minimum 25 mm orifice openings and integral sludge ring to eliminate clogging.
- e) The nozzles shall be threaded into the water distribution piping to assure positive positioning.
- f) Each cell shall have only one hot water return inlet, otherwise the cooling tower manufacturer shall provide the necessary extra provisions (piping, balancing valves, ...) to achieve the same at no extra cost.

2.5.3 Drift Eliminators

- a) The drift eliminators shall be constructed entirely inert polyvinyl (PVC) that has been specially treated to resist ultra violet light.
- b) Assembled in easily handled sections, the eliminator blades shall be spaced on 25 mm centers and shall incorporate three changes in air direction to assure efficient removal of entrained moisture from the discharge air stream.
- c) The maximum drift rate shall not exceed 0,001% of the recirculated water rate.
- d) The Drift Eliminators shall be certified according to Eurovent Standard OM-14-2009.

2.6 Sound Levels

The maximum sound pressure levels (dB) measured 15m from the cooling tower operating at full fan speed shall not exceed the sound levels detailed below.

Location	63Hz	125Hz	250Hz	500Hz	1000Hz	2000Hz	4000Hz	8000Hz	dB(A)
Discharge									
Air inlet									

3.0 ACCESSORIES (optional)

3.1 Electric Heaters

- a) The cooling tower cold water basin shall be provided with a electric heater package to prevent freezing of the water in the cold water basin.
- b) The electric heater package includes: electric heater elements and a combination of thermostat and low water level cutoff.
- c) The heaters shall be selected to maintain 4°C basin water temperature at ____°C ambient
- d) The heater(s) shall be ____V / ____ phase / ____ Hz electric power supply.

3.2 Three Probe Electric Water Level Control Package

- a) The cooling tower manufacturer shall provide an electric water level control package instead of the mechanical float valve arrangement.
- b) The package consist of the following elements:
 - Multiple heavy duty stainless steel SST 316 static probes mounted in a stilling tube outside the unit. Electrodes or sensors mounted inside the unit are not accepted as there operation will be disturbed by the moving water in the basin.
 - A ABS, IP 56 case contains all the contactors for the different level probes and will provide a output signal of a relay for automatic filling and one relay for alarm level.
 - The power supply to the control package is 24 Vac / 230 Vac - ____ Hz .
 - A weather protected solenoid valve for the water make up ready for Piping to a water supply with pressure between 140 kPa and 340 kPa.

3.3 Intake Sound Attenuation

- a) The unit will be equipped with intake sound attenuation consisting of a hot dip galvanized steel housing of the same quality of the unit and completed with acoustical baffles made of fiberglass material which is suitable for use in cooling towers.
- b) The intake sound attenuator is provided with large access doors which allow access to maintain the fans and bearings.
- c) The cooling tower motor size must be adjusted for the additional static pressure drop caused by the sound attenuator.

3.4 Discharge Sound Attenuation

- a) The unit will be equipped with discharge sound attenuation consisting of a hot dip galvanized steel housing of the same quality of the unit and completed with acoustical baffles made of fiberglass material which is suitable for use in cooling towers.



LSTE

SPECIFICATIONS

- b) The discharge sound attenuator is provided with large access doors which allow access to maintain the water distribution system and the drift eliminators without removing the baffles.
- c) The cooling tower motor size must be adjusted for the additional static pressure drop caused by the sound attenuator.

3.5 Vibration Switch

- a) A vibration limit switch shall be installed on the mechanical equipment support and wired into the control panel. The purpose of this switch will be to interrupt power the motor in the event of excessive vibration.
- b) The switch shall be adjustable for sensitivity, and shall require manual reset.

Notes:



World Headquarters/
Research and
Development Center

EVAPCO Manufacturing
Locations

EVAPCO, Inc.— World Headquarters & Research/Development Center

EVAPCO, Inc. • P.O. Box 1300 • Westminster, MD 21158 USA
Phone: +1 410-756-2600 • Fax: +1 410-756-6450 • E-mail: marketing@evapco.com

EVAPCO North America

**EVAPCO, Inc.
World Headquarters**

P.O. Box 1300
Westminster, MD 21158 USA
Phone: 410-756-2600
Fax: 410-756-6450
E-mail: marketing@evapco.com

EVAPCO East

5151 Allendale Lane
Taneytown, MD 21787 USA
Phone: 410-756-2600
Fax: 410-756-6450
E-mail: marketing@evapco.com

EVAPCO Midwest

1723 York Road
Greenup, IL 62428 USA
Phone: 217-923-3431
Fax: 217-923-3300
E-mail: evapcomw@evapcomw.com

EVAPCO West

1900 West Almond Avenue
Madera, CA 93637 USA
Phone: 559-673-2207
Fax: 559-673-2378
E-mail: contact@evapcowest.com

EVAPCO Iowa

925 Quality Drive
Lake View, IA 51450 USA
Phone: 712-657-3223
Fax: 712-657-3226

**EVAPCO Iowa
Sales & Engineering**

215 1st Street, NE
P.O. Box 88
Medford, MN 55049 USA
Phone: 507-446-8005
Fax: 507-446-8239
E-mail: evapcomn@evapcomn.com

EVAPCO Newton

701 East Jourdan Street
Newton, IL 62448 USA
Phone: 618-783-3433
Fax: 618-783-3499
E-mail: evapcomw@evapcomw.com

EVAPCO-BLCT Dry Cooling, Inc.

981 US Highway 22 West
Bridgewater, NJ 08807 USA
Phone: 1-908-379-2665
E-mail: info@evapco-blct.com

**Refrigeration Valves &
Systems Corporation**

A wholly owned subsidiary of EVAPCO, Inc.
1520 Crosswind Dr.
Bryan, TX 77808 USA
Phone: 979-778-0095
Fax: 979-778-0030
E-mail: rvs@rvscorp.com

McCormack Coil Company, Inc.

A wholly owned subsidiary of EVAPCO, Inc.
P.O. Box 1727
6333 S.W. Lakeview Boulevard
Lake Oswego, OR 97035 USA
Phone: 503-639-2137
Fax: 503-639-1800
E-mail: mail@mmccoil.com

EvapTech, Inc.

A wholly owned subsidiary of EVAPCO, Inc.
8331 Nieman Road
Lenexa, KS 66214 USA
Phone: 913-322-5165
Fax: 913-322-5166
E-mail: marketing@evaptechinc.com

Tower Components, Inc.

A wholly owned subsidiary of EVAPCO, Inc.
5960 US HWY 64E
Ramsour, NC 27316
Phone: 336-824-2102
Fax: 336-824-2190
E-mail: mail@towercomponentsinc.com

EVAPCO Europe

**EVAPCO Europe BVBA
European Headquarters**

Industrieterrein Oost 4010
3700 Tongeren, Belgium
Phone: (32) 12-395029
Fax: (32) 12-238527
E-mail: evapco.europe@evapco.be

EVAPCO Europe, S.r.l.

Via Ciro Menotti 10
I-20017 Passirana di Rho, Milan, Italy
Phone: (39) 02-939-9041
Fax: (39) 02-935-00840
E-mail: evapcoeuropa@evapco.it

EVAPCO Europe, S.r.l.

Via Dosso 2
23020 Piateda Sondrio, Italy

Flex Coil a/s

A subsidiary of Evapco, Inc.
Knøsgårdvej 115
9440 Aabybro, Denmark
Phone: (45) 9824-4999
Fax: (45) 9824-4990
E-mail: flexcoil@flexcoil.dk

EVAPCO Europe, GmbH

Insterburger Straße, 18
D-40670 Meerbusch, Germany
Phone: (49) 2159-69560
Fax: (49) 2159-695611
E-mail: info@evapco.de

EVAPCO S.A. (Pty.) Ltd.

A licensed manufacturer of Evapco, Inc.
18 Quality Road
Isando 1600, Republic of South Africa
Phone: (27) 11 392-6630
Fax: (27) 11-392-6615
E-mail: evapco@evapco.co.za

Evap Egypt Engineering Industries Co.

5 Al Nasr Road St.
Nasr City, Cairo, Egypt
Phone: (20) 2-24022866 / (20) 2-24044997/8
Fax: (20) 2-404-4667/ Mob: (20) 12-3917979
E-mail: primacool@link.net
shady@primacool.net

EVAPCO Asia/Pacific

**EVAPCO China
Asia/Pacific Headquarters**

1159 Luoning Rd. Baoshan Industrial Zone
Shanghai, P. R. China, Postal Code: 200949
Phone: (86) 21-6687-7786
Fax: (86) 21-6687-7008
E-mail: marketing@evapcochina.com

**Evapco (Shanghai) Refrigeration
Equipment Co., Ltd.**

1159 Luoning Rd., Baoshan Industrial Zone
Shanghai, P.R. China, Postal Code: 200949
Phone: (86) 21-6687-7786
Fax: (86) 21-6687-7008
E-mail: marketing@evapcochina.com

**Beijing EVAPCO Refrigeration
Equipment Co., Ltd.**

Yan Qi Industrial Development District
Huai Rou County
Beijing, P.R. China, Postal Code: 101407
Phone: (86) 10 6166-7238
Fax: (86) 10 6166-7395
E-mail: evapcobj@evapcochina.com

EVAPCO Australia Pty Ltd.

34-42 Melbourne Road - P.O. Box 436
Riverstone, N.S.W. Australia 2765
Phone: (61) 29 627-3322
Fax: (61) 29 627-1715
E-mail: sales@evapco.com.au

EvapTech Composites Sdn. Bhd

No. 70 (Lot 1289) Jalan Industri 2/3
Rawang Integrated Industrial Park
Rawang, Selangor, 48000 Malaysia
Phone: 60 3 6092-2209
Fax: 60 3 6092-2210

EvapTech Asia Pacific Sdn. Bhd

A wholly owned subsidiary of EvapTech, Inc.
IOI Business Park, 2/F Unit 20
Persiaran Puchong Jaya Selatan
Bandar Puchong Jaya,
47170 Puchong, Selangor, Malaysia
Phone: +(60-3) 8070 7255
Fax: +(60-3) 8070 5731
E-mail: marketing-ap@evaptech.com



EVAPCO... Specialists in Heat Transfer Products and Services.
Visit EVAPCO's Websites at: www.evapco.eu / www.mrgoodtower.eu



Mixed Sources
Cert no. S05-COC-100304
©1996 FSC