

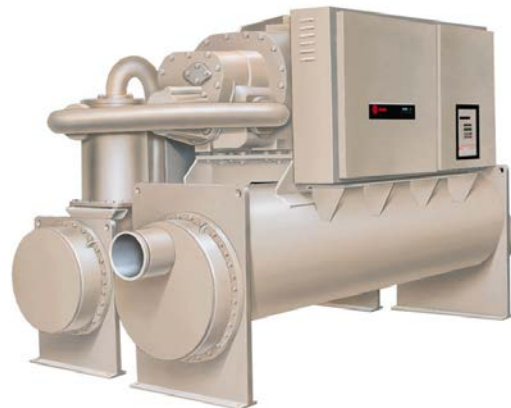

Air Conditioning Clinic

Helical-Rotary Water Chillers One of the Equipment Series





Helical-Rotary Water Chillers

One of the Equipment Series

A publication of Trane

Preface

Helical-Rotary Water Chillers

A Trane Air Conditioning Clinic

Figure 1

Trane believes that it's incumbent on manufacturers to serve the industry by regularly disseminating information gathered through laboratory research, testing programs and field experience.

The Trane Air Conditioning Clinic series is one means of knowledge sharing. It's intended to acquaint a nontechnical audience with various fundamental aspects of heating, ventilating, and air conditioning.

We've taken special care to make the clinic as uncommercial and straightforward as possible. Illustrations of Trane products only appear in cases where they help convey the message contained in the accompanying text.

This particular clinic introduces the reader to the concept of **helical-rotary water chillers**.

Contents

	Introduction	1
period one	Components	3
	Compressor	4
	Oil Separator	8
	Condenser	9
	Expansion Device	11
	Liquid/Vapor Separator	12
	Evaporator	13
	Controls and Starter	15
period two	Refrigeration Cycle	16
period three	Compressor Capacity Control	21
period four	Maintenance Considerations	25
period five	Application Considerations	31
	Air-Cooled or Water-Cooled Condensing	31
	Condensing Temperature Control	33
	Constant or Variable Evaporator Water Flow	35
	Short Evaporator Water Loops	36
	Equipment Certification Standards	38
period six	Review	40
	Quiz	44
	Answers	46
	Glossary	47



Introduction

notes

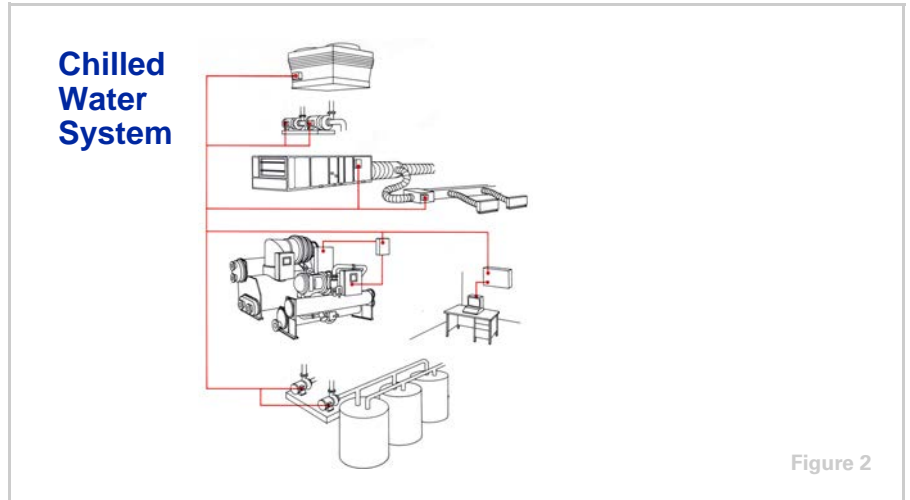

Water chillers are used in a variety of air conditioning and process cooling applications. They are used to make cold water that can be transported throughout a facility using pumps and pipes. This cold water can be passed through the tubes of coils in order to cool the air in an air conditioning application or it can provide cooling for a manufacturing or industrial process.

Systems that employ water chillers are commonly called **chilled water systems**.

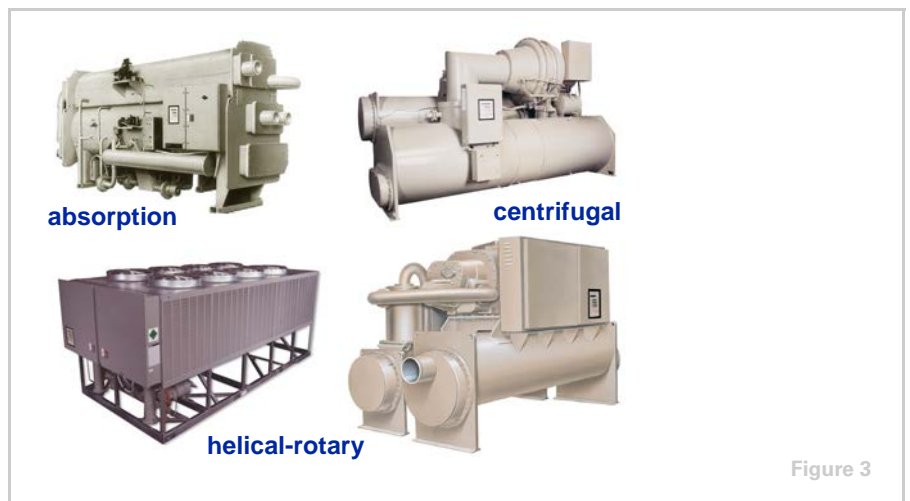

There are several types of water chillers that are differentiated by the refrigeration cycle they use or the type of compressor.

Absorption water chillers make use of the absorption refrigeration cycle and do not have a mechanical compressor involved in the refrigeration cycle. Absorption water chillers are the subject of a separate clinic.

Introduction

notes

Water chillers using the vapor-compression refrigeration cycle vary by the type of compressor used. Reciprocating and scroll compressors are typically used in smaller chillers. Helical-rotary (or screw) compressors are typically used in medium-sized chillers. Centrifugal compressors are typically used in larger chillers.

As mentioned earlier, this particular clinic discusses **helical-rotary water chillers**.



Helical-rotary water chillers can be either air-cooled or water-cooled, referring to the method of rejecting heat to the atmosphere. Both air-cooled and water-cooled helical-rotary chillers are generally available from 70 to 450 tons [200 to 1500 kW].

The primary focus in Period 1 is on the water-cooled chiller, although it includes some discussion of air-cooled chiller components. A comparison of air-cooled versus water-cooled chiller applications is included in Period 5.

period one Components

notes

Helical-Rotary Water Chillers

period one
Components

Figure 5

Many of the components of the helical-rotary water chiller are similar to those of other chiller types.

components of a Helical-Rotary Water Chiller

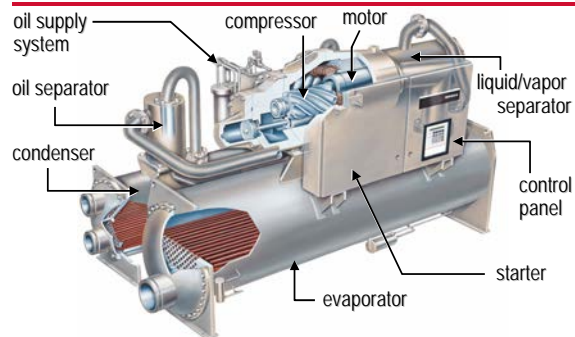

Figure 6

This particular helical-rotary water chiller makes use of a shell-and-tube evaporator where refrigerant evaporates inside the shell and water flows inside tubes. The compressor is a twin-rotor, helical-rotary compressor. It uses a suction-gas-cooled motor to operate the compressor. Another shell-and-tube heat exchanger is used for the condenser, where refrigerant is condensed inside the shell and water flows inside tubes. Refrigerant is metered through the system using an electronic expansion valve. A liquid/vapor separator can be used to enhance the effectiveness of the refrigeration cycle. An oil supply system provides near oil-free refrigerant to the shells to maximize heat transfer performance while providing lubrication and rotor sealing to the helical-rotary compressor. A control panel is also provided on the chiller, and a starter connects the chiller motor to the electrical distribution system.

period one
Components

notes

compressor...
Helical Rotors



Figure 7

Compressor

The helical-rotary chiller uses 2 screw-like **rotors** to perform the compression process.

compressor...
Helical Rotors

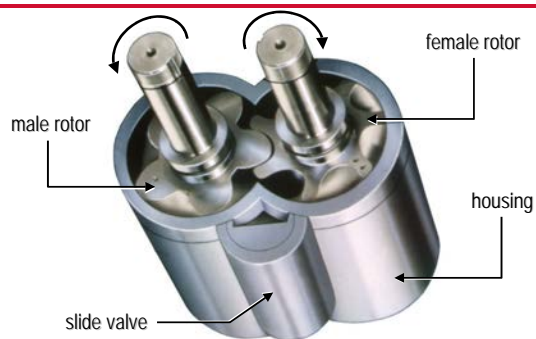

Figure 8

The rotors are meshed and fit, with very close tolerances, within a housing.

Only the male rotor is driven by the compressor motor. The lobes of the male rotor engage and drive the female rotor, causing the 2 parts to counter-rotate.

period one
Components

notes

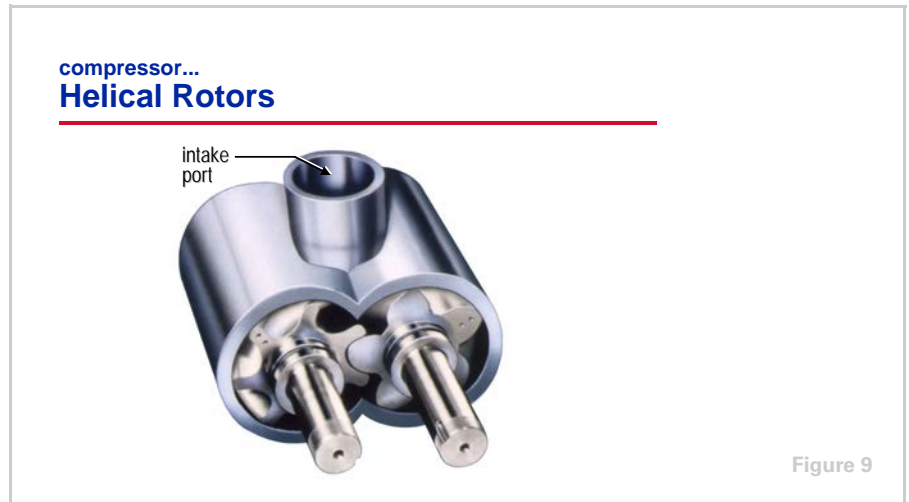

In the operation of the helical-rotary compressor, refrigerant vapor enters the compressor housing through the **intake port**. The intake port in this example is at the top of the compressor housing.

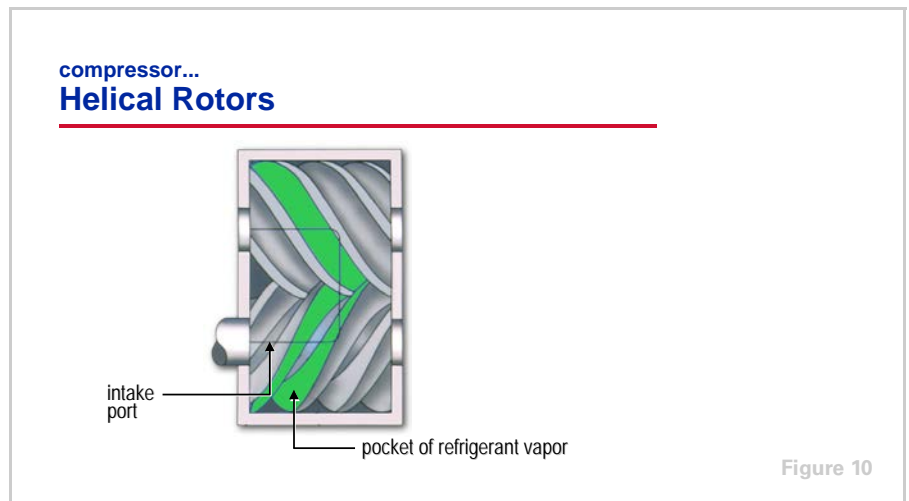

The entering refrigerant vapor is at a low, suction pressure and fills the grooves or pockets formed by the lobes of the rotors. As the rotors turn, they push the pockets of refrigerant toward the discharge end of the compressor.

period one
Components

notes

compressor...
Helical Rotors

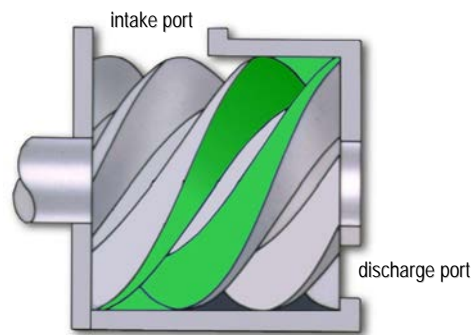

Figure 11

Viewing the compressor from the side shows that after the pockets of refrigerant travel to the right past the intake port area, the vapor, still at suction pressure, is confined within the pockets by the compressor housing.

compressor...
Helical Rotors

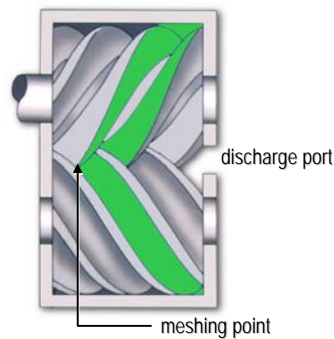

Figure 12

Viewing the compressor from the top shows that rotation of the meshed rotor lobes drives the trapped refrigerant vapor (to the right) ahead of the meshing point.

period one

Components

notes

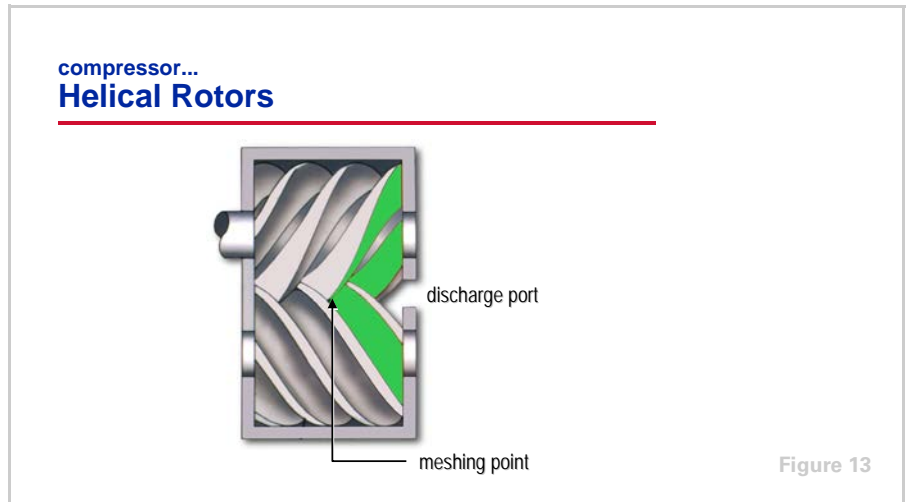

Continued rotation of the rotors causes the meshing point to travel toward the discharge end of the compressor, driving the trapped refrigerant vapor ahead of it. This action progressively reduces the volume of the pockets, compressing the refrigerant.

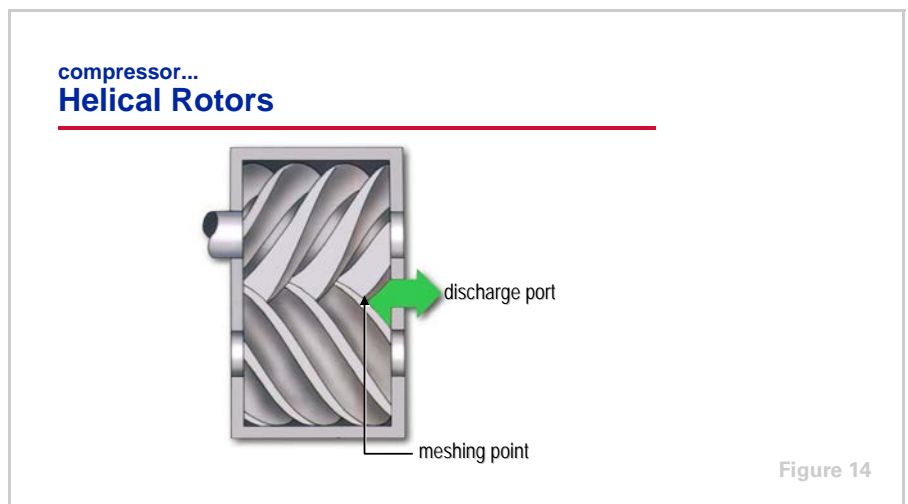

Finally, when the pockets of refrigerant reach the **discharge port** the compressed vapor is released. As the rotors continue to rotate, the volume of the pockets is further reduced, squeezing the remaining refrigerant from the cavities.

Notice that the refrigerant vapor enters and exits the compressor through ports—no valves are used. Compressors of this design are called **ported compressors**.

period one
Components

notes

Oil Separator

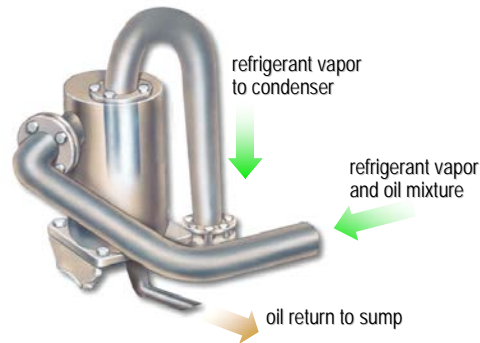

Figure 15

Oil Separator

The oil leaves the compressor entrained within the discharged refrigerant vapor.

The oil is recovered from the discharged refrigerant by an **oil separator**, which can have an efficiency of greater than 99%. The separator consists of a vertical cylinder surrounding an exit passageway. As the refrigerant-and-oil mixture is discharged into this passageway the oil is forced outward by centrifugal force, collects on the walls of the cylinder, and drains to the bottom. This accumulated oil drains out of the cylinder and collects in the oil sump located near the bottom of the chiller.

The oil sump is heated to ensure proper lubrication and minimize refrigerant condensation in the sump.

Oil Supply System

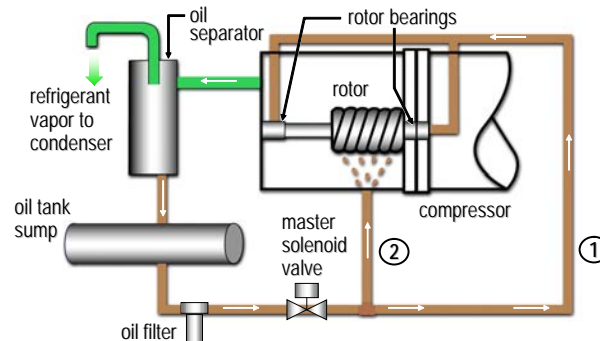

Figure 16

Oil that collects in the oil sump is at condensing pressure during compressor

period one

Components

notes

operation and is, therefore, constantly moving to lower pressure areas of the chiller. In this system, oil flows in 2 distinct paths, each performing a separate function: 1) bearing lubrication and cooling and 2) rotor oil injection.

Oil leaves the sump and passes through an oil filter and master solenoid valve. The master solenoid valve is used to isolate the sump from the low-pressure side of the system when the compressor is shut down, preventing oil migration.

The first path is for lubricating and cooling the compressor bearings ①. Oil is routed to the bearings located in the rotor and bearing housing. Each housing is vented to the suction side of the compressor so that oil leaving the bearings is routed through the rotors, to the oil separator, and then back to the oil sump.

The second path is for lubricating and sealing the compressor rotors ②. Oil is injected along the bottom or top of the compressor rotors inside the housing. Its main purpose is to seal the rotor-to-rotor and rotor-to-housing clearances. This seal provides a barrier between the high- and low-pressure cavities of the compressor. Additionally, oil lubricates the male-to-female rotor drive arrangement.

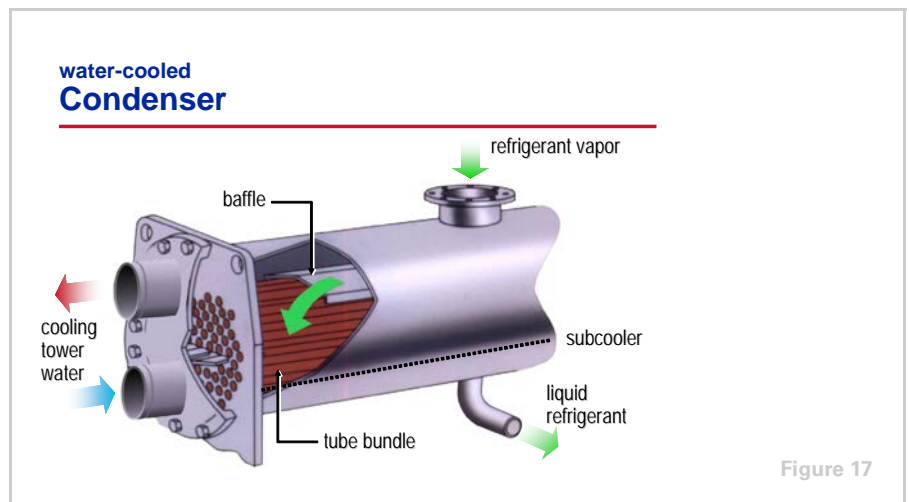

Condenser

The high-pressure refrigerant vapor, now stripped of oil droplets, leaves the oil separator and continues on to the condenser.

In a **water-cooled condenser**, water is pumped through the tubes of this shell-and-tube heat exchanger while refrigerant vapor fills the shell space surrounding the tubes. The condenser has a baffle plate that helps distribute the refrigerant evenly within the shell. As heat is transferred from hot, high-pressure refrigerant vapor to the water, refrigerant condenses on the tube surfaces.

The condensed liquid refrigerant then collects in the bottom of the shell where the lower tubes are now submerged, resulting in further cooling, or subcooling, of the refrigerant. This arrangement is called an integral **subcooler**.

period one

Components

notes

Cooling water flows first through the lower tubes of the condenser and then through the upper tubes. This produces a nearly constant temperature difference between the downward moving refrigerant and the tube surfaces, resulting in a uniform heat transfer rate within the tube bundle.

Subcooled liquid refrigerant leaves the condenser (subcooler) and flows through the liquid line to the expansion device.

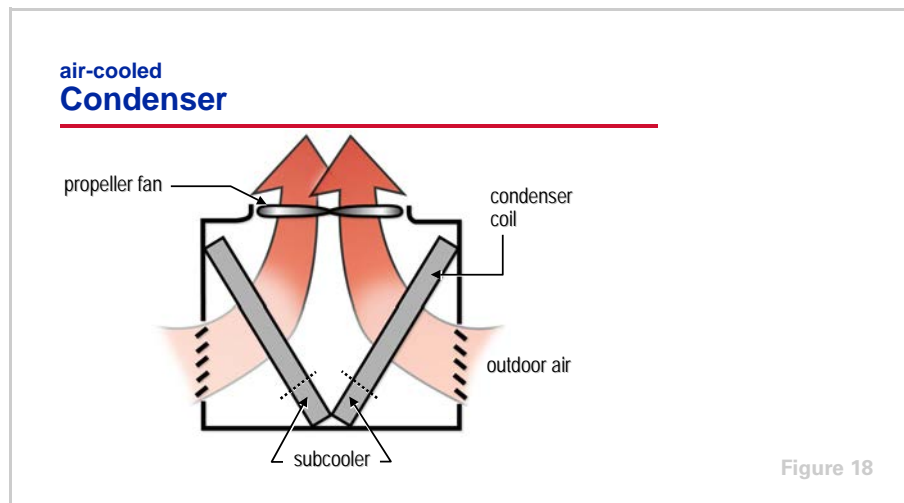

In a typical **air-cooled condenser**, propeller-type fans are used to draw outdoor air over a fin-tube heat transfer surface. The hot, high-pressure refrigerant vapor flows through the tubes as heat is transferred to the cooler outdoor air. The resulting reduction in the heat content of the refrigerant vapor causes it to condense into liquid. Within the final few lengths of condenser tubing the condensed liquid refrigerant is subcooled.

Again, subcooled liquid refrigerant leaves the condenser (subcooler) and flows through the liquid line to the expansion device.

The differences between water-cooled and air-cooled chiller applications will be discussed further in Period 5.

period one

Components

notes

expansion device...

Electronic Expansion Valve



Figure 19

Expansion Device

An expansion device is used to maintain the pressure difference between the high-pressure (condenser) and low-pressure (evaporator) sides of the system, as established by the compressor. This pressure difference allows the evaporator temperature to be low enough to absorb heat from the water being cooled, while also allowing the refrigerant to be at a high enough temperature in the condenser to reject heat to air or water at normally available temperatures. High-pressure liquid refrigerant flows through the expansion device, causing a large pressure drop that reduces the refrigerant pressure to that of the evaporator. This pressure reduction causes a small portion of the liquid to boil off, or flash, cooling the remaining refrigerant to the desired evaporator temperature.

In this chiller, the expansion device used is an **electronic expansion valve**. In addition to maintaining the high- and low-side pressure difference, the electronic expansion valve controls the quantity of liquid refrigerant entering the evaporator to ensure that it will be completely vaporized within the evaporator.

period one

Components

notes

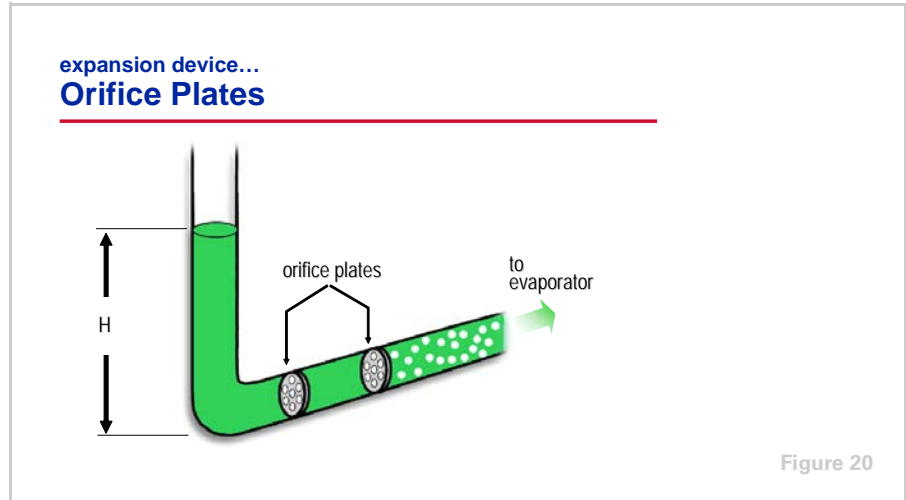

The **orifice plate** is another type of expansion device found in helical-rotary chillers. The column of liquid refrigerant creates a head pressure at its base, allowing it to pass through the orifices and undergo a pressure drop equal to the head (H) before it flashes. As the load decreases, less refrigerant is moved throughout the chiller, causing the level of the liquid column to drop. This causes additional flashing at the orifice plate which, in turn, results in feeding less liquid to the evaporator.

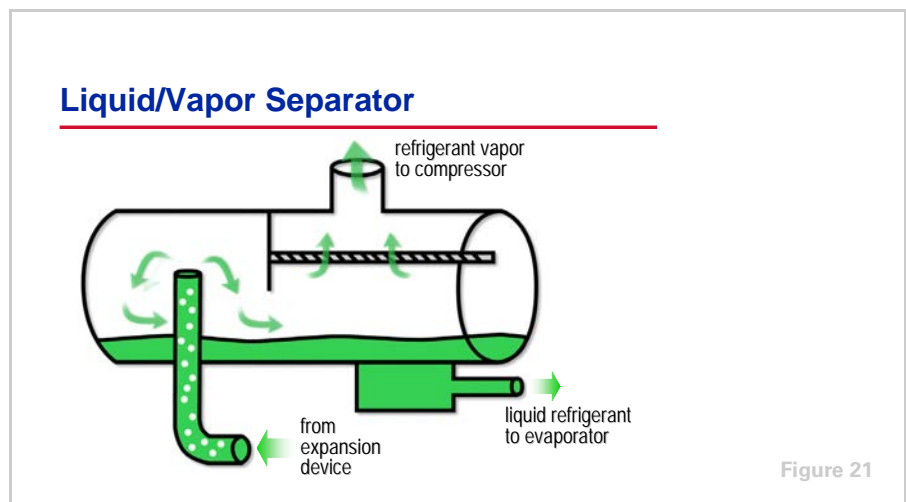

Liquid/Vapor Separator

The mixture of liquid and vapor refrigerant that leaves the expansion device enters a **liquid/vapor separator**. Here the liquid refrigerant settles to the bottom of the chamber and the vapor is drawn off the top and routed directly to the suction side of the compressor. The remaining liquid refrigerant is then routed to the evaporator.

period one

Components

notes

By removing the vapor portion of the mixture before it gets to the evaporator the separator enhances the effectiveness of the evaporation process.

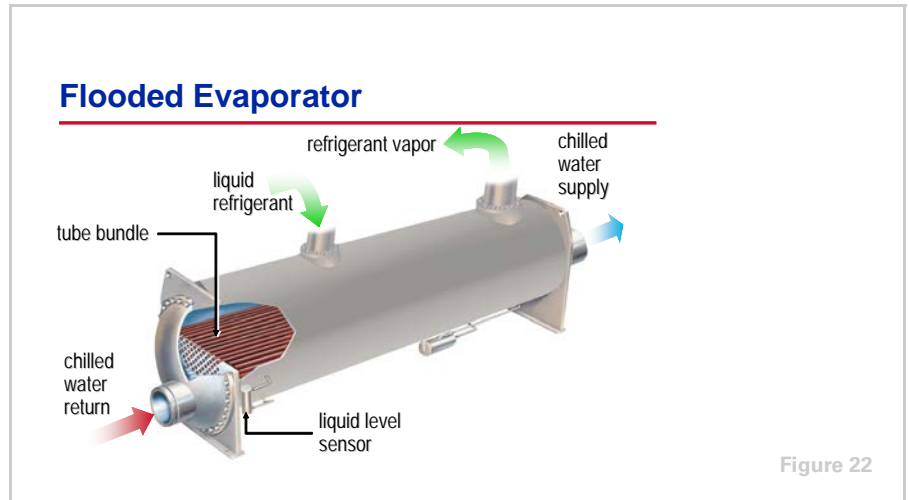

Evaporator

In the flooded **shell-and-tube evaporator** cool, low-pressure liquid refrigerant enters the distribution system inside the shell and is distributed uniformly over the tubes, absorbing heat from relatively warm water that flows through the tubes. This transfer of heat boils the film of liquid refrigerant on the tube surfaces and the resulting vapor is drawn back to the compressor. The cooled water can now be used in a variety of comfort or process applications.

A sensor can monitor the level of liquid refrigerant in this type of evaporator and the electronic expansion valve can be used to carefully meter the liquid refrigerant flow to the evaporator's distribution system in order to maintain a relatively low level of refrigerant in the evaporator shell.

period one
Components

notes

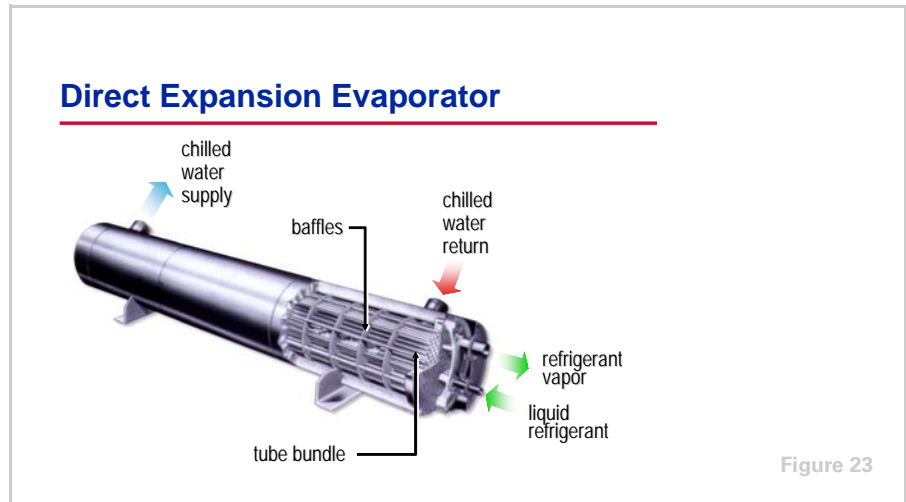

Another type of evaporator found in helical-rotary chillers is the **direct expansion (DX) shell-and-tube evaporator**. In this type of evaporator the cool, low-pressure liquid refrigerant flows through the tubes and water fills the surrounding shell. As heat is transferred from the water to the refrigerant, the refrigerant boils inside the tubes and the resulting vapor is drawn to the compressor. Baffles within the shell direct the water in a rising and falling flow path over the tubes that carry the refrigerant. The resulting turbulence improves heat transfer.

Since the tubes of a flooded evaporator contain water, they can be mechanically cleaned without removing the refrigerant charge. The tubes of a direct expansion evaporator must be chemically cleaned. Additionally, flooded evaporators are typically more effective, but are more costly.

period one

Components

notes

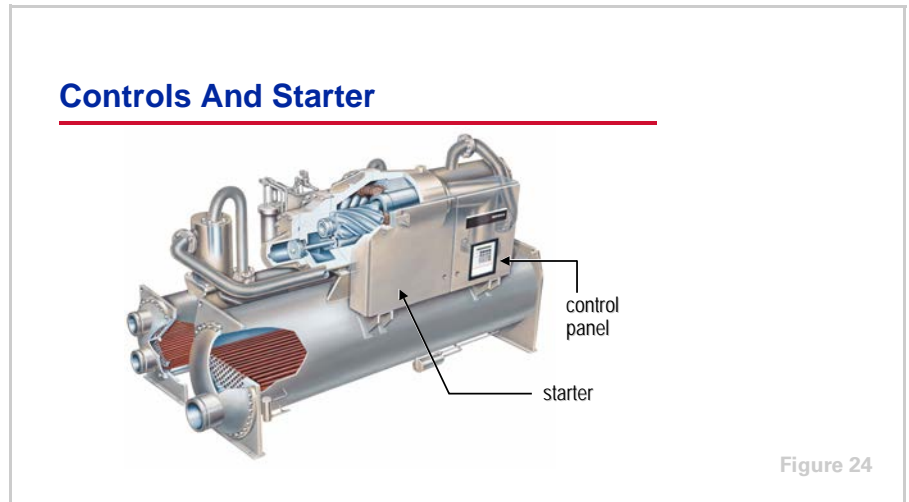

Controls and Starter

A microprocessor-based **control panel** is provided on the chiller to provide accurate chilled water control as well as monitoring, protection, and adaptive limit functions. These controls monitor the chiller's operation and prevent the chiller from operating outside of its limits. They can compensate for unusual operating conditions while keeping the chiller running by modulating system components, rather than simply tripping off due to a safety setting. Furthermore, when problems do occur, diagnostic messages aid in troubleshooting.

This control system not only provides accurate, optimized control and protection for the chiller, but permits interfacing with a building automation system for integrated system control. In a chilled water system, optimal control is a system-wide issue, not just a chiller issue.

Because compressor motors create such a large electrical load, they cannot be started and stopped using a simple switch or plug. A **starter** provides a linkage between the motor and the electrical distribution system. Its primary function is to connect (start) and disconnect (stop) the chiller from the line. The starter also includes a transformer that provides power to the chiller control panel and components to perform overload protection and current-limiting functions. Finally, the application of a chiller starter also requires considering a means of disconnect and short circuit protection.

period two

Refrigeration Cycle

notes

Helical-Rotary Water Chillers

period two

Refrigeration Cycle

Figure 25

A pressure-enthalpy (p-h) chart illustrates the refrigeration cycle of the helical-rotary water chiller.

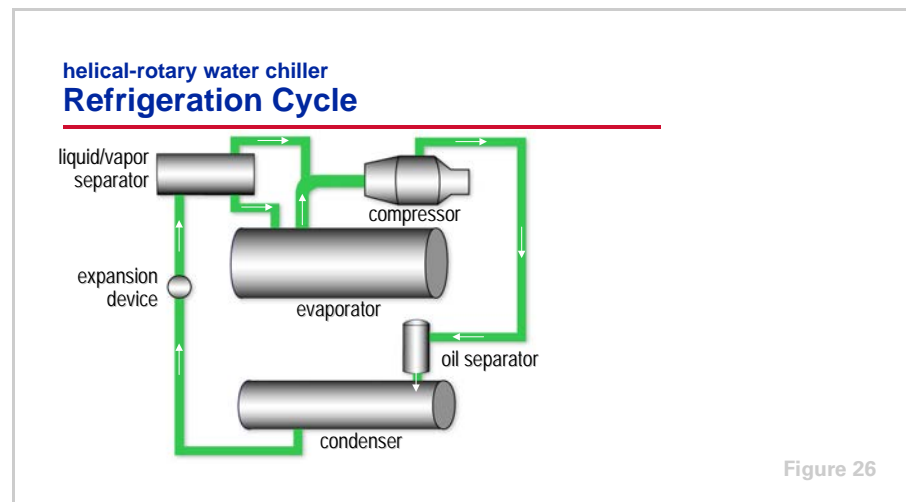

But first, let's review the components of the helical-rotary chiller's refrigeration cycle...

Refrigerant vapor leaves the evaporator and flows to the compressor where it is compressed to a higher pressure and temperature. Oil is removed from refrigerant vapor in the oil separator and the refrigerant travels to the condenser while the oil is recirculated back to the compressor.

In the condenser, the refrigerant vapor rejects heat to water or air and leaves as a sub-cooled liquid. The pressure drop created by the expansion device causes a portion of the liquid refrigerant to evaporate and the resulting mixture of liquid and vapor refrigerant enters the liquid/vapor separator. Here the vapor is

period two

Refrigeration Cycle

notes

separated from the mixture and routed directly to the suction side of the compressor and the remaining liquid refrigerant enters the evaporator.

In the evaporator, the liquid refrigerant boils as it absorbs heat from water. The resulting vapor is drawn back to the compressor to repeat the cycle.

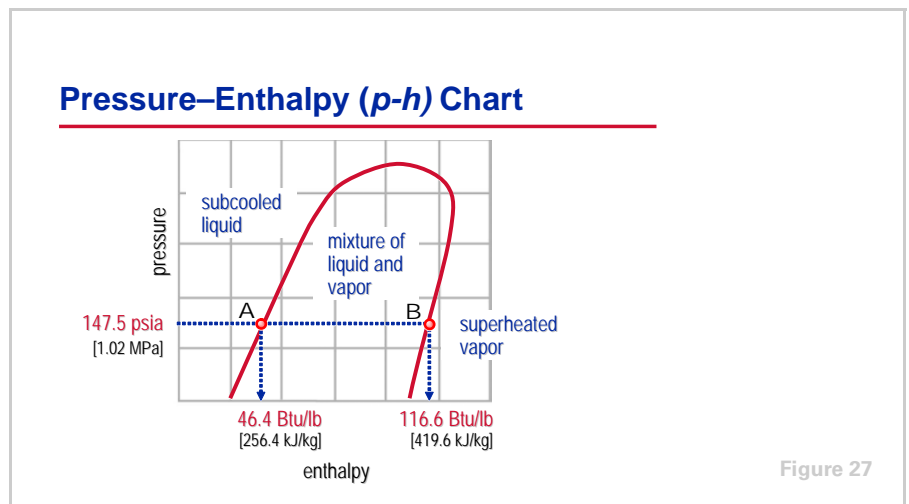

The pressure-enthalpy chart is simply a plot of the saturated properties of a refrigerant. It plots refrigerant pressure (vertical axis) versus enthalpy (horizontal axis). Enthalpy is a measurement of the heat content, both sensible and latent, per pound [kg] of refrigerant.

For example, **A** represents the heat content of saturated *liquid* HFC-134a refrigerant at 147.5 psia [1.02 MPa] and 104°F [40°C]. **B** represents the heat content of saturated *vapor* HFC-134a refrigerant at the same pressure and temperature. The difference in heat content, or enthalpy, between **A** and **B**—that is, 70.2 Btu/pound [163.2 kJ/kg]—is the amount of heat required to transform 1 pound [1 kg] of saturated liquid refrigerant to saturated refrigerant vapor at the same pressure and temperature.

If the heat content of the refrigerant at any pressure falls to the right of the curve, the vapor is superheated. Similarly, if the heat content of the refrigerant falls to the left of the curve, the liquid is subcooled. Finally, when the heat content of the refrigerant falls inside the curve the refrigerant exists as a liquid/vapor mixture.

period two

Refrigeration Cycle

notes

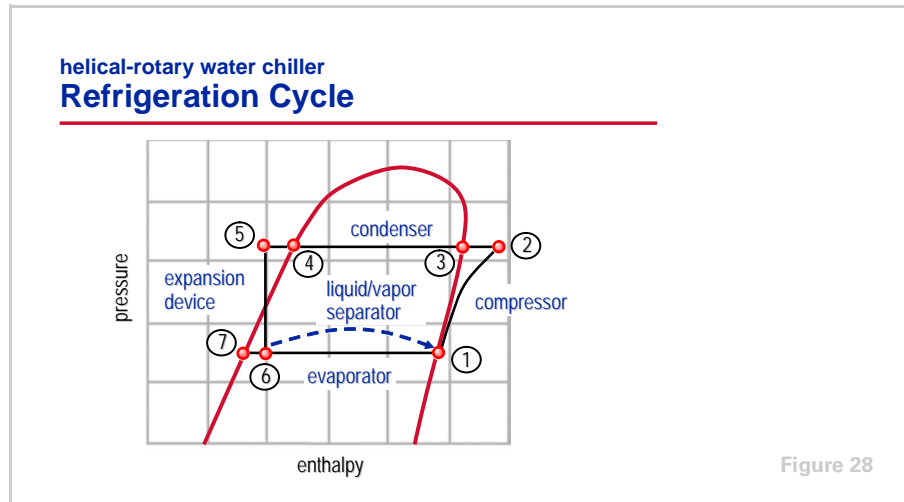

The theoretical vapor-compression refrigeration cycle for a helical-rotary water chiller can be plotted on a pressure-enthalpy chart.

The refrigerant leaves the evaporator as saturated vapor ① and flows to the suction end of the compressor where it enters the compartment for the suction-gas-cooled motor. Here the refrigerant flows across and cools the motor, then enters the compression chamber. The refrigerant vapor is compressed in the compressor to a high pressure and temperature ②. Energy input to the motor and compressor is imparted to the refrigerant as superheat. Superheated refrigerant vapor leaves the compressor and enters the condenser.

Water or air flowing through the condenser absorbs heat from the hot, high-pressure refrigerant. This reduction in the heat content of the refrigerant vapor causes it to desuperheat ③, condense into liquid ④, and further sub-cool ⑤ before leaving the condenser to travel to the expansion device.

The pressure drop created by the expansion process causes a portion of the liquid refrigerant to evaporate. The evaporating refrigerant absorbs heat from the remaining liquid refrigerant. The resulting mixture of cold liquid and vapor refrigerant enters the liquid/vapor separator ⑥. Here the vapor is separated from the mixture and routed directly to the suction side of the compressor ① and the remaining liquid refrigerant enters the evaporator ⑦.

The cool low-pressure liquid refrigerant enters the distribution system in the evaporator shell and is distributed over the tubes in the evaporator tube bundle, absorbing heat from water that flows through the tubes. This transfer of heat boils the film of liquid refrigerant on the tube surfaces and the resulting vapor is drawn back to the compressor ① to repeat the cycle.

period two
Refrigeration Cycle

notes

helical-rotary water chillers...
Refrigerants

- HCFC-22
- HFC-134a
- HFC-404a
- HFC-407c
- HFC-410a

Figure 29

Manufacturers are continuously improving their designs of helical-rotary water chillers. New chillers need to be designed around the characteristics of the refrigerant. Today there are 5 strong candidates for use with positive-displacement, helical-rotary chillers. They are HCFC-22, HFC-134a, HFC-404a, HFC-407c and HFC-410a.

period two

Refrigeration Cycle

notes

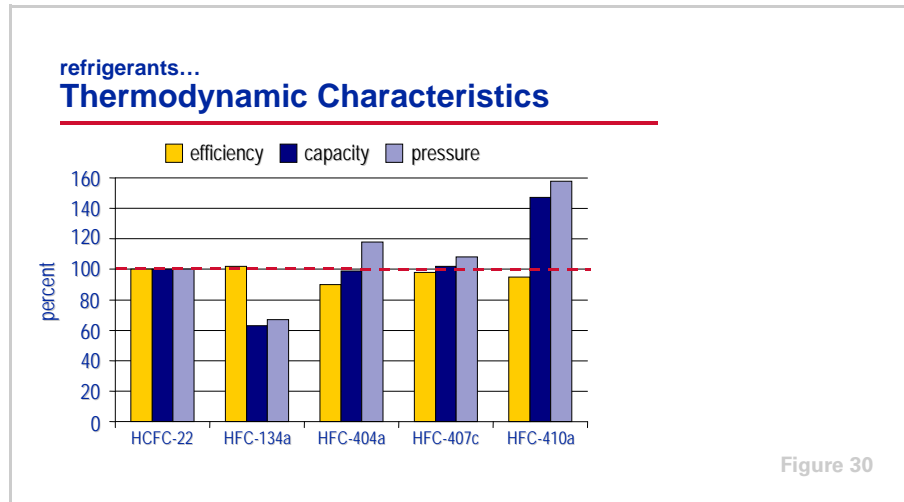

Today the most commonly used refrigerant in helical-rotary chillers is HCFC-22. Due to the scheduled phaseout of HCFC-22, most helical-rotary chillers will be redesigned using HFC refrigerants. Many challenges are encountered when redesigning a chiller to use a refrigerant with different thermodynamic characteristics. This is due to the different efficiency, capacity, and operating pressure characteristics of each of the refrigerants.

Take a closer look at each of these issues by examining the effects of using different refrigerants in the same helical-rotary chiller designed for use with HCFC-22.

- **Efficiency** – In order to meet today’s high standards of energy efficiency, chillers using refrigerants with a lower thermal efficiency, such as HFC-404a and HFC-410a, will require larger heat exchangers and more efficient compressors. These changes add to the product cost and increase the physical size of the chiller.

- **Capacity** – HFC-134a has a lower capacity compared to HCFC-22, which means more refrigerant needs to be pumped through the chiller to achieve the same capacity. This can be accomplished by using a larger compressor or increasing the speed of the compressor. Both tend to increase product cost and design complexity. On the other hand, HFC-410a has a higher capacity compared to HCFC-22, which means less refrigerant needs to be pumped through the chiller to achieve the same capacity. The advantage is that smaller, less expensive compressors can be used.

- **Operating Pressure** – A refrigerant that operates at a higher pressure requires heat exchangers and pressure vessels to be designed for the higher pressure. This adds cost. Conversely, higher pressure refrigerants have a greater density. As density increases, the required amount of refrigerant decreases, meaning that smaller or slower-speed compressors can be used. Lower pressure refrigerants, such as HFC-134a, will require larger or higher-speed compressors in order to achieve the same capacity as a similar chiller using HCFC-22.

period three

Compressor Capacity Control

notes

Helical-Rotary Water Chillers

period three

Compressor Capacity Control

Figure 31

The capacity of the helical-rotary compressor presented in this clinic is controlled by a **slide valve** that is an integral part of the compressor housing.

Other helical-rotary compressor designs may use a variety of methods to vary capacity. Some of these methods are similar in function to the slide valve presented in this period. One major difference is whether the compressor is designed to unload in steps, like a reciprocating compressor, or if it has variable unloading.

Slide Valve

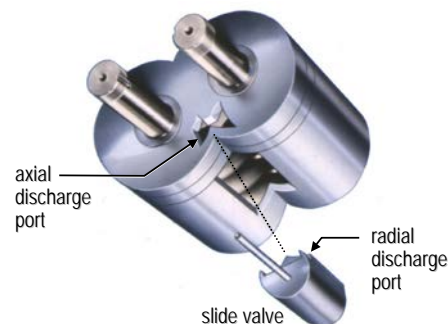

Figure 32

The position of the slide valve along the rotors controls the volume of refrigerant vapor being delivered by the compressor, by varying the amount of rotor length actually being used for compression.

Note that the compressor discharge has 2 components. First, a port within the slide valve provides a **radial discharge** path. Second, a port within the end-plate of the compressor housing provides an **axial discharge** path.

period three

Compressor Capacity Control

notes

slide valve position... Full Load

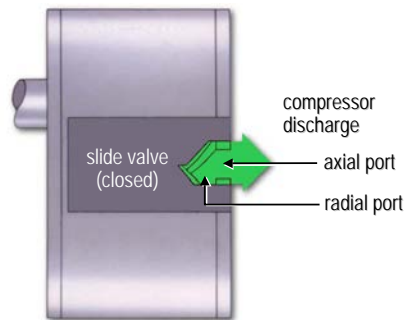

Figure 33

At full load, the slide valve is closed. The compressor pumps its maximum volume of refrigerant, discharging it through both the radial and axial ports.

slide valve position... Part Load

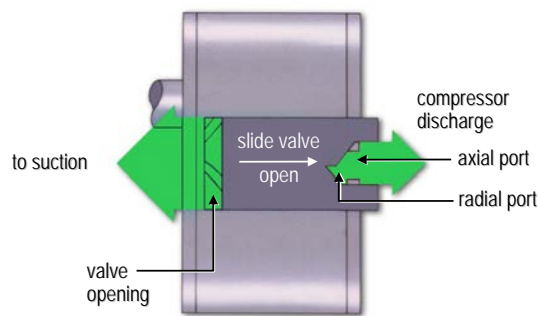

Figure 34

At part load, the slide valve modulates toward the open position. The opening created by the valve movement allows refrigerant vapor to bypass from the rotor pockets back to the suction side of the compressor. This reduces the volume of vapor available for the compression process. It also reduces the amount of rotor length available for compression. In this manner, the volume of refrigerant that is pumped by the compressor is varied, unloading it to balance the existing chiller load.

period three

Compressor Capacity Control

notes

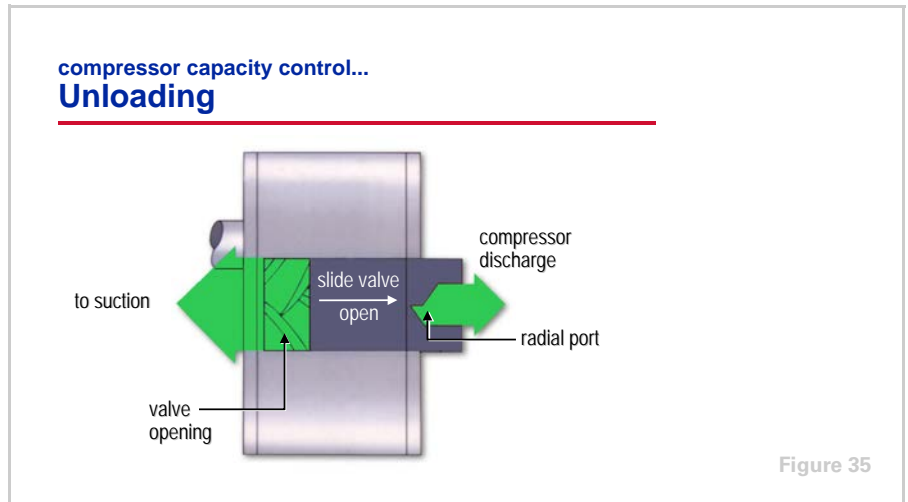

As the slide valve continues to open, further unloading the compressor, its radial discharge port eventually travels past the opening in the compressor housing. Once this occurs, all of the refrigerant vapor being pumped by the compressor is discharged through the axial port in the compressor's end-plate.

The compressor discharge ports and slide valve are designed to allow the compressor to operate efficiently over a wide range of conditions.

period three

Compressor Capacity Control

notes

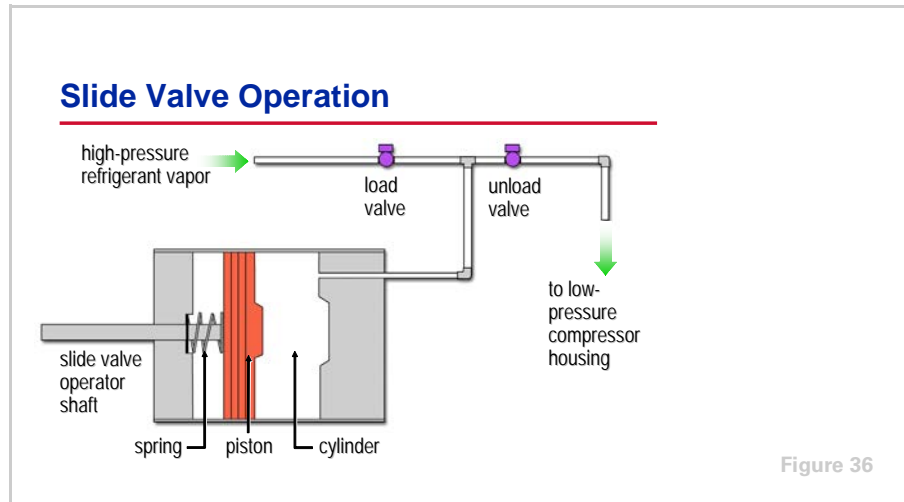

The slide valve is operated by a piston and cylinder assembly. Extension and retraction of the operator shaft positions the slide valve along the compressor rotors.

High-pressure refrigerant vapor, controlled by 2 solenoid valves, is fed to or bled from this assembly in order to position the valve. To close the slide valve and load the compressor, the load valve is opened and the unload valve is closed. This allows high-pressure refrigerant vapor to enter the cylinder from the discharge of the compressor, extending the operator shaft and moving the slide valve so that it covers more of the rotor length.

Conversely, to open the slide valve and unload the compressor, the load valve is closed and the unload valve is opened. This allows the high-pressure refrigerant vapor to bleed out of the cylinder into the low-pressure area within the compressor housing. A spring helps return the piston, retracting the operator shaft and moving the slide valve such that the rotors are more uncovered. This reduces the effective length of the rotors, which are compressing vapor.

On shutdown the unload solenoid valve is energized and the spring drives the slide valve to the fully-unloaded position. This ensures that the compressor always starts fully unloaded.

When both solenoid valves are closed, the operator shaft holds the slide valve at its current position.

period four

Maintenance Considerations

notes

Helical-Rotary Water Chillers

period four

Maintenance Considerations

Figure 37

This period discusses general maintenance requirements of helical-rotary water chillers. Although some of the information applies specifically to the design presented in this clinic, requirements for other helical-rotary chiller designs are also included.

helical-rotary water chillers

Maintenance Considerations

- Operating log
- Mechanical components
- Heat transfer surfaces
- Fluid analysis

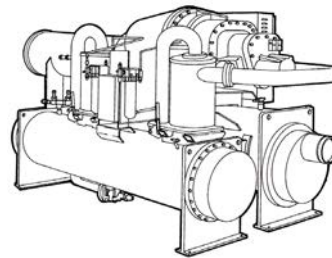

Figure 38

Once a helical-rotary chiller is installed and put into operation, it usually continues to function without a full-time attendant. In many cases, the machine starts and stops on a schedule controlled by the building automation system or a simple time clock. The only daily maintenance requirement is to check the operating log.

Water chillers are designed for maximum reliability with a minimum amount of maintenance. Like all large mechanical systems, however, certain routine maintenance procedures are either required or recommended.

period four

Maintenance Considerations

notes

operating log ASHRAE Guideline 3

- Chilled water inlet and outlet temperatures and pressures
- Chilled water flow
- Evaporator refrigerant temperature and pressures
- Evaporator approach temperature
- Condenser water inlet and outlet temperatures and pressures
- Condenser water flow
- Condenser refrigerant temperature and pressures
- Condenser approach temperature
- Compressor refrigerant suction and discharge temperatures
- Refrigerant level
- Oil pressures, temperature, and levels
- Addition of refrigerant
- Addition of oil
- Vibration levels



Figure 39

The American Society of Heating, Refrigerating and Air Conditioning Engineers (ASHRAE) has published Guideline 3 titled *Reducing Emission of Halogenated Refrigerants in Refrigeration and Air Conditioning Equipment and Systems*. This guideline includes a recommended list of data points to be logged daily for each chiller. Much of this data may be available through the chiller's control panel.

Special attention should be given to the following:

- Review the operating log and trends
- Measure the oil pressure drop to determine if the oil filter needs to be replaced
- Measure refrigerant superheat and subcooling
- Measure both the refrigerant and oil charges

period four

Maintenance Considerations

notes

maintenance considerations

Mechanical Components

- **Required maintenance**
 - ◆ Compressor and motor: no maintenance required
 - ◆ Controls: no maintenance or calibration required
- **Recommended maintenance**
 - ◆ Visually inspect overall unit
 - ◆ Inspect safety controls and electrical components
 - ◆ Tighten electrical connections
 - ◆ Check for leaks
 - ◆ Test vent piping

Figure 40

Direct-drive, semi-hermetic compressor designs require no periodic maintenance on the compressor/motor assembly. The compressor contains only 3 main moving parts: the male and female rotors and the slide valve. The semi-hermetic motor eliminates the need for external shaft seals associated with open motors. These seals are a prime source of oil and refrigerant leaks. It also eliminates annual coupling and seal inspections, alignment, and shaft seal replacement.

With the advent of microprocessor-based controls, the control panel and auxiliary controllers require no recalibration or maintenance. Remote-mounted electronic sensors send information to the unit controller, which can be connected to a building automation system in order to communicate information and allow for system-level optimization. These systems can notify the operator with an alarm or diagnostic message when a problem occurs.

Like any mechanical equipment, a daily visual inspection of the chiller is recommended to look for oil leaks, condensation, loosened electrical or control wiring, or signs of corrosion. Special attention should be given to the safety controls and electrical components.

It is recommended that a qualified service technician check the chiller annually for leaks. In the normal service of any air conditioning system, the United States EPA mandates that whenever a refrigeration circuit is opened, recovery of the refrigerant is required.

Finally, the vent piping of all pressure relief valves should be leak-tested annually for the presence of refrigerant to detect improperly sealed valves. Leaking relief valves should be replaced.

period four

Maintenance Considerations

notes

maintenance considerations

Mechanical Components

- **Other design-specific requirements:**

- ◆ Change oil when oil analysis dictates
- ◆ Replace oil filter periodically
- ◆ Replace filter drier periodically
- ◆ Clean oil strainers annually
- ◆ Check shaft alignment annually
- ◆ Check coupling annually
- ◆ Replace shaft seal every 2 to 4 years
- ◆ Compressor teardown inspection every 5 to 10 years

Figure 41

Some helical-rotary compressor designs do require periodic maintenance of mechanical system components. This includes oil and refrigerant filter changes, oil strainer changes, and a compressor rotor inspection.

Open-motor compressor designs require shaft alignment, coupling inspection, bearing lubrication, and cleaning of the motor windings, rotor ends, and fan blades on a quarterly or annual basis.

In all cases, strictly follow the manufacturer's published maintenance requirements and recommendations.

maintenance considerations

Heat Transfer Surfaces

- **Recommended maintenance**

- ◆ Use a qualified water treatment specialist
- ◆ Clean condenser tubes as needed (water-cooled)
- ◆ Clean water-side strainers
- ◆ Test tubes every 3 years
- ◆ Clean condenser coils as needed (air-cooled)

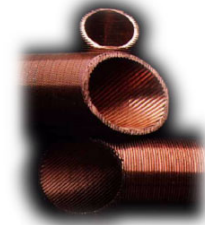

Figure 42

Optimum performance of heat transfer components depends on keeping the heat transfer surfaces free from scale and sludge. Even a very thin deposit of scale can substantially reduce heat transfer capacity. Owners of water-cooled chillers should engage the services of a qualified water treatment specialist to

period four

Maintenance Considerations

notes

determine the level of water treatment required to remove contaminants from the cooling tower water.

Scale deposits are best removed by chemical means. The water-cooled condenser is commonly isolated from the rest of the cooling tower water circuit by valves, and a pump circulates cleaning solution through the condenser tubes.

Sludge is removed mechanically. This involves removing the water boxes from the condenser and loosening the deposits with a stiff-bristled brush. The loosened material is then flushed from the tubes with clear water. As part of this procedure, the strainers on both the chilled water and cooling tower water circuits should be cleaned every year.

Every 3 years, or more frequently for process or critical applications, it is recommended that a qualified service organization perform non-destructive tube inspections on both the evaporator and condenser tubes. The eddy-current tube test is a common method.

Rarely, problems may arise that cause refrigerant or water leaks. These must be repaired immediately.

For air-cooled chillers, the condenser coils should be cleaned at least annually in order to maintain proper efficiencies and operating conditions. Follow the manufacturer's instructions to avoid damage to the coils.

maintenance considerations

Fluid Analysis

- **Oil analysis**
 - ◆ Conduct annual analysis to verify system integrity
 - ◆ Measure oil pressure drop to determine if filter needs changing
 - ◆ Measure charge
- **Refrigerant charge**
 - ◆ Measure charge and trim as necessary
 - ◆ Measure superheat and subcooling



Figure 43

Probably the most important annual maintenance task required for helical-rotary water chillers is an oil analysis. It may be conducted more frequently for chillers that run continuously or more often than normal. This test, performed by a qualified laboratory, verifies the integrity of the refrigeration system by testing the moisture, acidity, and metal concentration levels. This analysis can determine where problems exist or could potentially develop. By taking oil samples on a regular basis, normal operating trends for the compressor and bearing metals can be analyzed. As opposed to changing the oil once a year whether it needs it or not, regular oil analyses can be used to determine proper oil change intervals as well as predict major problems before they occur.

period four

Maintenance Considerations

notes

Refrigerant analysis measures contamination levels and determines suitability for continued use. It can also determine the acceptability of recycled refrigerant for reuse. Refrigerant analysis helps extend the life of the existing charge and ensures that the chiller is operating at peak efficiency.

Logging the oil and refrigerant charges, and examining the trends of this data, can help identify potential problems before they occur.

maintenance considerations

Fluid Analysis

• Why perform regular oil analyses?

- ◆ Helps reduce maintenance costs
- ◆ Detects problems without compressor disassembly
- ◆ Extends service life of oil charge
- ◆ Reduces environmental problems related to oil disposal
- ◆ Helps maintain compressor efficiency and reliability
- ◆ Helps lower refrigerant emissions



Figure 44

An oil analysis is a key preventive maintenance measure and should be conducted at least annually. It will help the compressor last longer while improving chiller efficiency and reducing refrigerant emissions. A certified chemical laboratory has years of experience in analyzing oil and refrigerant from all types of compressors.

Often the chiller manufacturer can provide this service.

period five

Application Considerations

notes

Helical-Rotary Water Chillers

period five

Application Considerations

Figure 45

There are several considerations to address when applying helical-rotary water chillers, including:

- Air-cooled or water-cooled condensing
- Condensing temperature control
- Constant or variable evaporator water flow
- Short evaporator water loops
- Equipment certification standards

This section is by no means the entire list of considerations, but is representative of some of the key issues.

condenser types...

Air-Cooled or Water-Cooled

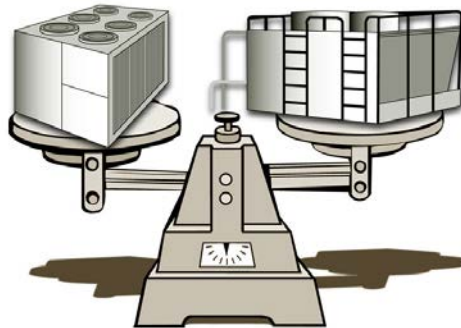

Figure 46

Air-Cooled or Water-Cooled Condensing

Although this is not a new consideration, the question of which condenser type to apply continues to receive attention. A major advantage of air-cooled chillers

period five

Application Considerations

notes

is the elimination of the cooling tower. This eliminates the concerns and maintenance requirements associated with water treatment, makeup water availability and quality, tower mechanical maintenance, freeze protection, and chiller condenser tube cleaning. This reduced maintenance requirement is particularly attractive since it can substantially reduce operating costs.

Another advantage of an air-cooled chiller is its delivery as a “packaged system.” Reduced design time, simplified installation, higher reliability, and single-source responsibility are all factors that make the factory packaging of the condenser, compressor, and evaporator a major benefit. A water-cooled chiller has the additional requirement of condenser water piping, pump, cooling tower, and controls.

Air-cooled chillers are often selected in buildings with a requirement for year-round cooling that cannot be met with an air-side economizer. Air-cooled condensers have the ability to operate in below-freezing weather without the problems associated with operating the cooling tower in low-ambient conditions. Cooling towers may require special sequences of operation, basin heaters, or even an indoor sump for safe operation in freezing weather.

air-cooled or water-cooled Comparison



air-cooled

- Lower maintenance
- Packaged system
- Better low ambient operation



water-cooled

- Greater energy efficiency
- Longer equipment life

Figure 47

Water-cooled chillers are generally more energy efficient. The efficiency advantage of a water-cooled chiller, however, is much less when the additional cooling tower and condenser pump energy costs are considered. Additionally, this efficiency advantage may lessen at part-load conditions since the dry bulb temperature tends to drop faster than the wet bulb temperature and the air-cooled chiller benefits from greater condenser relief.

Performing a comprehensive energy analysis is the best method of estimating the system operating cost difference between air-cooled and water-cooled systems.

Water-cooled chillers typically last longer than air-cooled chillers. This difference is due to the fact that the air-cooled chiller is installed outdoors, whereas the water-cooled chiller is installed indoors. Also, using water as the condensing fluid allows the water-cooled chiller to operate at lower pressures

period five

Application Considerations

notes

and temperatures that the air-cooled chiller. Generally, air-cooled chillers last 15 to 20 years, while water-cooled chillers last 20 to 25 years.

To summarize the comparison of air-cooled and water-cooled helical-rotary chillers, air-cooled chiller advantages include lower maintenance cost, a pre-packaged system for easier design and installation, and better low ambient operation. Water-cooled chiller advantages include greater energy efficiency (at least at design conditions) and longer equipment life.

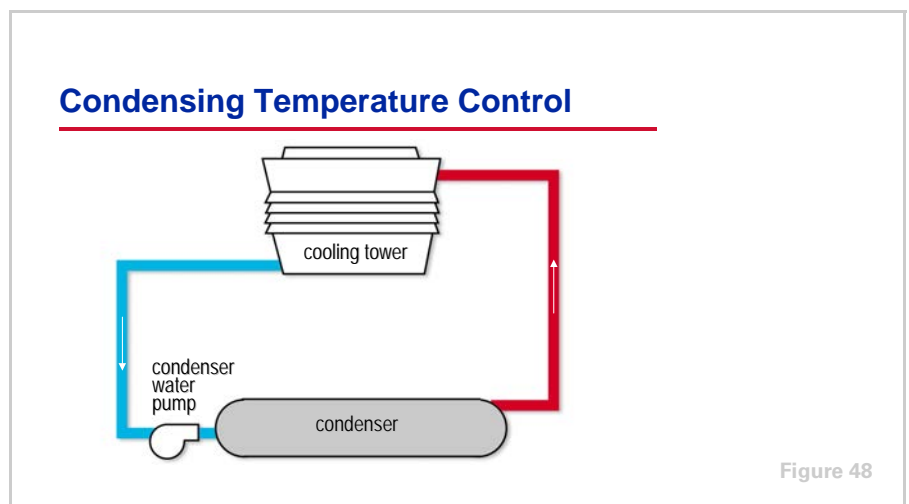

Condensing Temperature Control

All chillers require a minimum pressure difference between the evaporator and condenser to ensure proper management of oil and refrigerant. This minimum pressure difference depends on the chiller design and controls. The most common method of maintaining this pressure difference at the various load conditions is to control the condensing temperature by varying the temperature or flow rate of water (or air) flowing through the condenser. By controlling the condensing temperature, most helical-rotary water chillers can start and operate over a wide range of conditions.

Controlling condensing temperature: 1) maintains chiller efficiency, 2) maintains the required pressure differential between the evaporator and condenser for controlled flow through the refrigerant metering system, and 3) prevents the pressure imbalance that could cause oil loss problems.

Controlling the refrigerant pressure difference between the evaporator and condenser of an air-cooled chiller is accomplished by varying the flow rate of the air flowing through the condenser coils. This control is an integral part of the chiller design.

period five

Application Considerations

notes

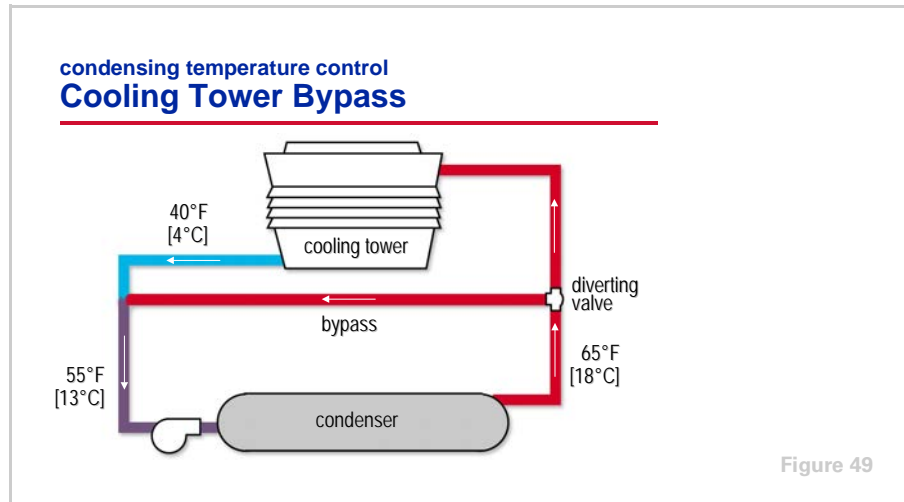

Controlling the refrigerant pressure difference between the evaporator and condenser of a water-cooled chiller is accomplished by varying the temperature or flow rate of the water flowing through the condenser. The following are 5 common methods used to control condensing temperature:

- 1) Controlling the temperature of the water leaving the cooling tower by cycling or varying the speed of the cooling tower fans
- 2) Using a cooling tower bypass pipe to mix warmer leaving-condenser water with the colder tower water and control the temperature entering the condenser as illustrated in the accompanying slide
- 3) Modulating a throttling valve to restrict the flow of water through the condenser
- 4) Using a chiller bypass pipe to vary the flow rate of water through the condenser
- 5) Employing a variable-speed drive on the condenser water pump to vary the water flow rate through the condenser

Each of these strategies has its advantages and disadvantages, and selection of the appropriate condensing temperature control scheme depends on the specific application.

The water flow rate through the chiller's condenser must stay between the minimum and maximum condenser bundle flow rates as specified by the chiller manufacturer.

period five

Application Considerations

notes

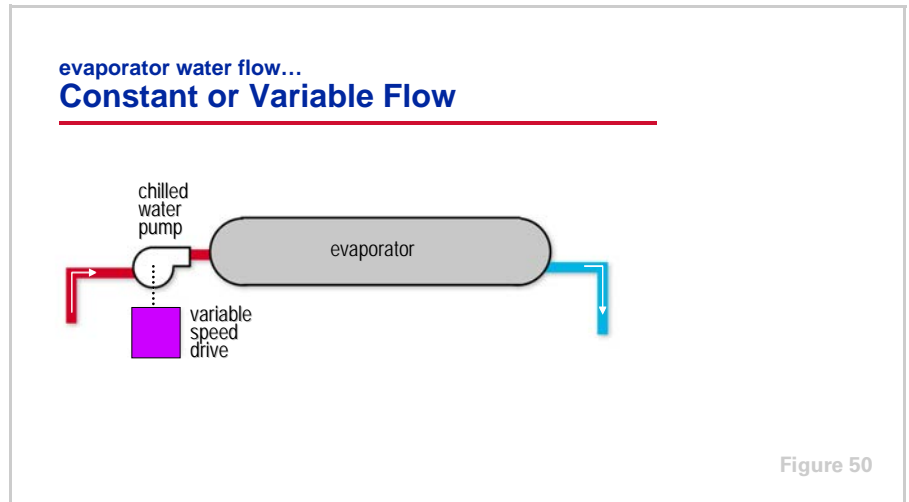

Constant or Variable Evaporator Water Flow

In previous designs, chillers were required to maintain a constant flow rate of water through the evaporator. This requirement has changed due to advances in chiller controls. Increased sensing and control capabilities now allow chiller manufacturers to design controls that monitor, and respond faster to, fluctuating conditions.

While the chiller may be able to handle variable water flow through the evaporator, the specific application of a chilled water system may not warrant variable flow. As always, each application should be analyzed to determine if variable evaporator water flow is warranted.

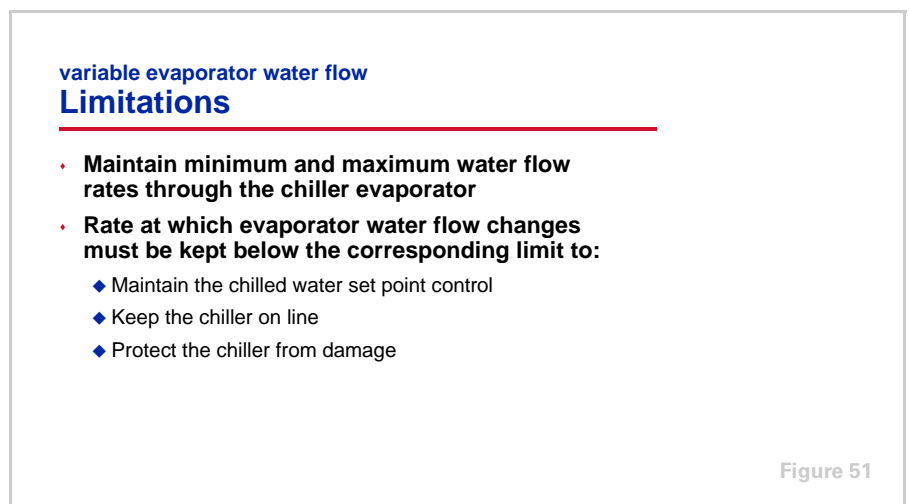

The controls on many current chiller designs can properly control the chiller in response to varying evaporator flow rates, with the following limitations:

period five

Application Considerations

notes

1) The water flow rate through the chiller's evaporator must stay between the minimum and maximum evaporator bundle flow rates as specified by the chiller manufacturer. These limits depend on the specific details of the actual evaporator bundle, such as the number of tubes, number of passes, and geometry of the bundle. A method for sensing evaporator water flow through each chiller is the only way to make sure the water flow rate stays within these limits.

2) The rate which the evaporator water flow rate changes must be kept below a specified level, which is dependent on the level of protection desired. For example, the maximum rate of change in order to maintain chilled water setpoint is more stringent than the maximum rate of change in order to keep the chiller on line. There are 3 common levels of protection desired: maintaining chilled water setpoint control, keeping the chiller on line, and protecting the chiller from damage.

The limits for these different levels of protection should be obtained from the chiller manufacturer.

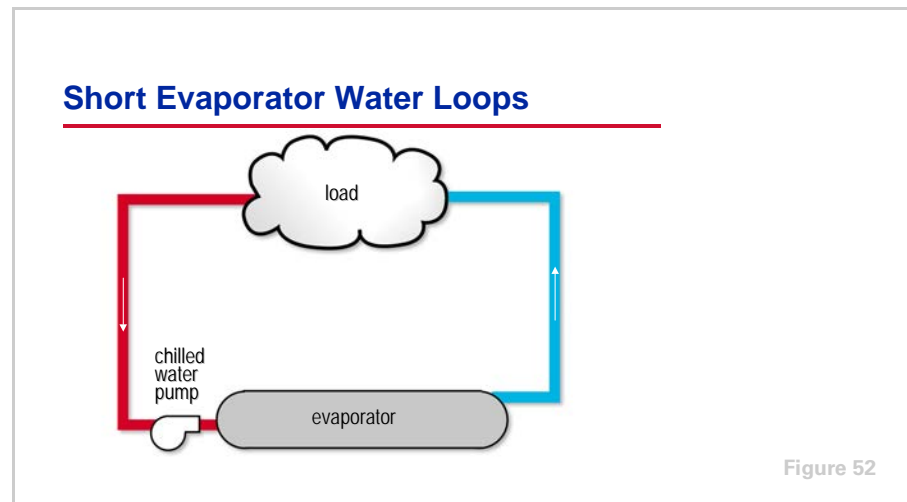

Short Evaporator Water Loops

Proper chilled water temperature control requires that the temperature of the chilled water returning to the evaporator not change any faster than the chiller controls can respond. The volume of water in the evaporator loop acts as a buffer and ensures a slowly changing return water temperature and, therefore, stable temperature control. If there is not a sufficient volume of water in the loop to provide an adequate buffer, temperature control can be lost, resulting in erratic system operation.

The chiller manufacturer should be consulted for volume requirements of the evaporator water loop.

period five

Application Considerations

notes

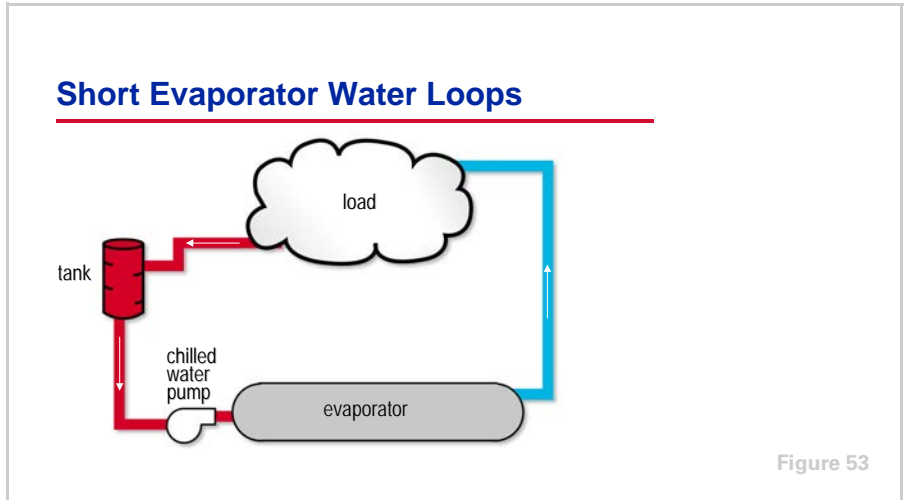

Short water loops may be unavoidable in close-coupled or very small applications, particularly in systems where the load consists of only a few air handlers or processes.

To prevent the effect of a short water loop, a storage tank or large header pipe can be added to the system to increase the volume of water in the loop and act as a buffer to ensure a slowly changing return water temperature.

period five

Application Considerations

notes

equipment certification standards **ARI Standard 550/590**

- **Purpose**

- ◆ Establish definitions and testing and rating requirements

- **Scope**

- ◆ Factory designed and prefabricated water chillers
- ◆ Vapor-compression refrigeration
- ◆ Air-cooled and water-cooled condensing



Figure 54

Equipment Certification Standards

The Air Conditioning & Refrigeration Institute (ARI) establishes rating standards for packaged HVAC equipment. ARI also certifies and labels equipment through programs that involve random testing of a manufacturer's equipment to verify published performance.

The overall objective of ARI Standard 550/590–1998 is to promote consistent rating and testing methods for all types and sizes of water chillers with an accurate representation of actual performance. It covers factory-designed, prefabricated water chillers, both air-cooled and water-cooled, using the vapor-compression refrigeration cycle.

period five

Application Considerations

notes

equipment certification standards **ARI Standard 550/590**

- **Standard rating conditions**
 - ◆ Common system conditions for published ratings
- **Integrated Part Load Value (IPLV)**
 - ◆ Part-load efficiency rating
 - ◆ Based on an “average” single-chiller installation
 - ◆ Standard operating conditions

Figure 55

The standard rating conditions used for ARI certification represent typical design temperatures and flow rates for which water-cooled and air-cooled systems are designed. They are not suggestions for good design practice for a given system, they are simply a common rating point. Trends toward improved humidity control and energy efficiency have changed some of the actual conditions selected for specific applications.

ARI's part-load efficiency rating system establishes a single, blended estimate of stand-alone chiller performance. The Integrated Part Load Value (IPLV) calculator predicts chiller efficiency at the ARI standard rating conditions using weighted averages representing a broad range of geographic locations, building types, and operating-hour scenarios, both with and without an airside economizer. While the weighted averages place greater emphasis on the part-load operation of an average, single-chiller installation, they will not—by definition—represent any particular installation.

Additionally, ARI notes that more than 80 percent of all chillers are installed in multiple-chiller plants. Chillers in these plants exhibit different unloading characteristics than the IPLV weighted formula indicates. Appendix D of the Standard explains this further:

...The [IPLV] equation was derived to provide a representation of the average part-load efficiency for a single chiller only. However, it is best to use a comprehensive analysis that reflects actual weather data, building load characteristics, operational hours, economizer capabilities, and energy drawn by auxiliaries such as pumps and cooling towers, when calculating the chiller and system efficiency. This becomes increasingly important with multiple chiller systems because individual chillers operating within multiple chiller systems are more heavily loaded than single chillers within single chiller systems.

Remember that the ARI rating is a standardized representation. Many chillers do not run at standard rating conditions and few are applied in single-chiller installations. Performing a comprehensive energy analysis is the best method of comparing the system operating cost difference between 2 chillers.

period six **Review**

notes

Helical-Rotary Water Chillers

period six
Review

Figure 56

Let's review the main concepts that were covered in this clinic on helical-rotary water chillers.

Review—Period 1

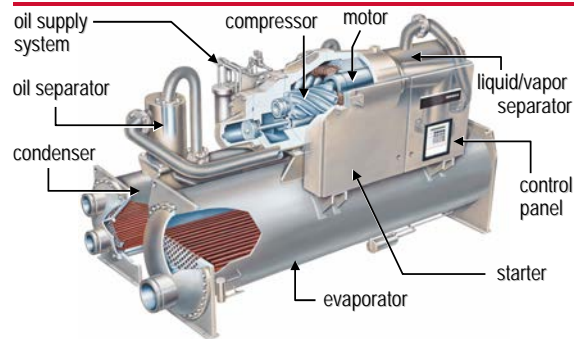

Figure 57

In Period 1, the following components of a helical-rotary water chiller were discussed: compressor, oil separator, oil supply system, condenser, expansion device, liquid/vapor separator, evaporator, starter, and controls.

period six Review

notes

Review—Period 2

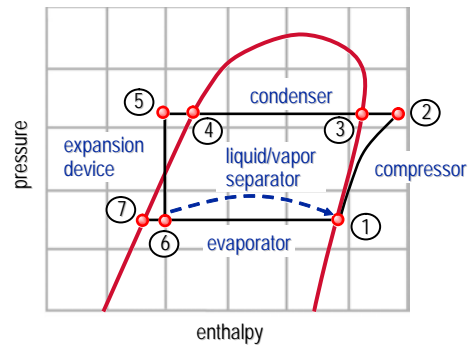

Figure 58

In Period 2, the refrigeration cycle of the helical-rotary water chiller was examined on a pressure-enthalpy chart. Also, the performance characteristics of the various refrigerants were compared.

Review—Period 3

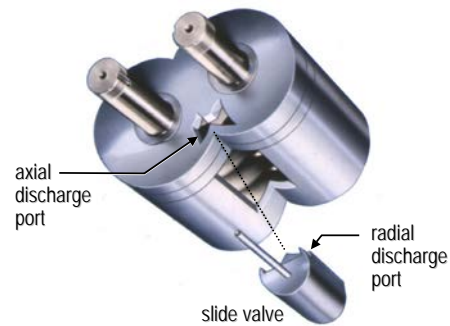

Figure 59

In Period 3, the operation of the modulating slide valve was explained. The slide valve is one method by which a helical-rotary compressor's capacity is controlled.

period six

Review

notes

Review—Period 4

- **Maintenance considerations**
 - ◆ Operating log
 - ◆ Mechanical components
 - ◆ Heat transfer surfaces
 - ◆ Fluid analysis

Figure 60

In Period 4, the general maintenance requirements of a helical-rotary water chiller were discussed, including:

- Recommended data to be logged daily
- Required and recommended maintenance of the mechanical components
- Required and recommended maintenance of the heat transfer surfaces
- Recommended analysis of the oil and refrigerant

Review—Period 5

- **Application considerations**
 - ◆ Air-cooled or water-cooled
 - ◆ Condensing temperature control
 - ◆ Constant or variable evaporator water flow
 - ◆ Short evaporator water loops
 - ◆ Equipment certification standards

Figure 61

In Period 5, several considerations in the application of helical-rotary water chillers were presented. These included air-cooled or water-cooled condensing, condensing temperature control, constant or variable evaporator water flow, short evaporator water loops, and equipment certification standards.

period six **Review**

notes



For more information, refer to the following references:

- Trane product catalogs for helical-rotary water chiller products (Trane literature order numbers RLC-DS-1, RLC-DS-2, RLC-DS-4, and RLC-DS-6)
- Water-Cooled Series R® Chiller—Model RTHC Mechanical Operation (RLC-EB-16)
- Series R® CenTraVac® Chiller Condensing Water Temperature Control (RLC-EB-4)
- Multiple Chiller System Design And Control (CON-AM-21)
- ARI Standard 550/590–1998: Implications For Chilled-Water Plant Design (Trane *Engineers Newsletter*, 1999—volume 28, no. 1)
- ASHRAE Handbook—Refrigeration
- ASHRAE Handbook—Systems and Equipment

Visit the ASHRAE Bookstore at www.ashrae.org.

For information on additional educational materials available from Trane, contact your local Trane sales office (request a copy of the Educational Materials price sheet — Trane order no. EM-ADV1) or visit our online bookstore at www.trane.com/bookstore/.

Quiz

Questions for Period 1

- 1** What components of the helical-rotary compressor are used to compress the refrigerant?
- 2** What are the 2 functions of the oil supply system presented in this clinic?
- 3** In a flooded shell-and-tube evaporator, is the refrigerant flowing inside or outside of the tubes?
- 4** Name 2 types of expansion devices commonly found in helical-rotary water chillers.

Questions for Period 2

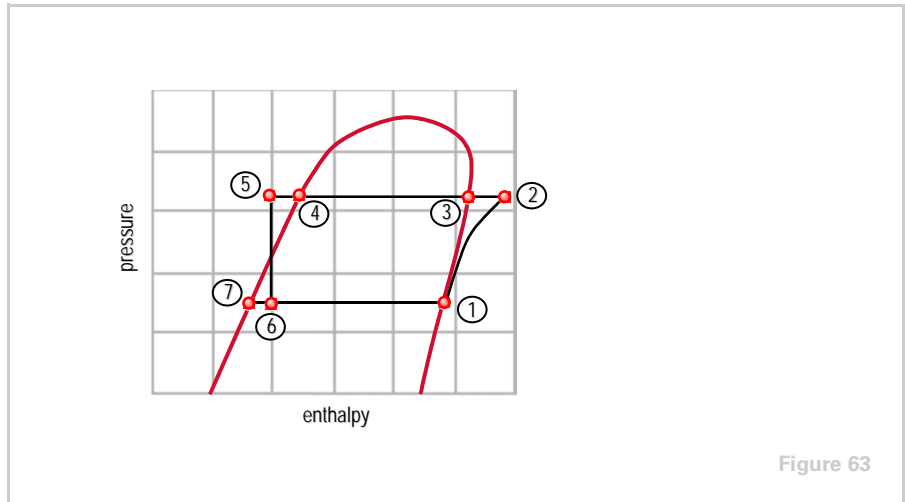

- 5** Using the pressure-enthalpy diagram in Figure 63, identify the following processes of the helical-rotary water chiller's refrigeration cycle:
 - a)** ① to ②
 - b)** ② to ⑤
 - c)** ⑤ to ⑥
 - d)** ⑦ to ①
- 6** Referring again to Figure 63, after the vapor is removed in the liquid/vapor separator, to which point in the refrigeration cycle does it travel?

Quiz

Questions for Period 3

- 7** At full load, is the slide valve fully closed or fully open?
- 8** Explain how the slide valve varies the refrigerant flow rate through the helical-rotary compressor.

Questions for Period 4

- 9** What document recommends the data points to be logged daily for each chiller?
- 10** List 3 advantages to performing a regular oil analysis on a helical-rotary water chiller.

Questions for Period 5

- 11** List 3 common methods of controlling condensing pressure in a water-cooled chiller.
- 12** What are the 2 primary limitations with varying the flow rate of water through the chiller evaporator?

Answers

- 1** Male and female screw rotors
- 2** Bearing lubrication and cooling, and rotor oil injection
- 3** Outside of the tubes
- 4** Electronic expansion valve and orifice plate
- 5) a)** compression
b) condensation (desuperheat, condense, subcool)
c) expansion
d) evaporation
- 6** Point 1, the suction inlet of the compressor
- 7** Fully closed
- 8** At part load, the opening created by the slide valve movement allows refrigerant vapor to bypass from the rotor pockets back to the suction side of the compressor. This reduces the volume of vapor available for the compression process. It also reduces the amount of rotor length available for compression.
- 9** ASHRAE Guideline 3
- 10** Helps reduce maintenance costs, detects problems without compressor disassembly, oil charges last longer, less environmental problems with disposing of used oil, helps maintain the compressor's efficiency and reliability, and helps lower refrigerant emissions.
- 11** Cycling or varying the speed of the cooling tower fans, using a cooling tower bypass pipe, modulating a throttling valve, using a chiller bypass pipe, or employing a variable-speed drive on the condenser water pump.
- 12** The water flow rate through the chiller's evaporator must stay between the minimum and maximum evaporator bundle flow rates as specified by the chiller manufacturer. The rate which the evaporator water flow rate changes must be kept below a specified level.

Glossary

air-cooled condenser A type of condenser that rejects the heat of the refrigerant to air flowing through it.

ARI Air Conditioning & Refrigeration Institute

ARI Standard 550/590 A publication, titled “Standard for Water Chilling Packages Using the Vapor-Compression Cycle”; used to promote consistent rating and testing methods for all types and sizes of water chillers. It covers factory-designed, prefabricated water chillers, both air-cooled and water-cooled, using the vapor-compression refrigeration cycle.

ASHRAE American Society of Heating, Refrigerating and Air Conditioning Engineers

ASHRAE Guideline 3 A publication, titled “Reducing Emission of Halogenated Refrigerants in Refrigeration and Air Conditioning Equipment and Systems”; that includes a recommended list of data points to be logged daily for each water chiller.

compressor The mechanical device used by the chiller to increase the pressure and temperature of the refrigerant vapor.

condenser The region of the chiller where refrigerant vapor is converted to liquid as it rejects heat to water or air.

control panel The microprocessor-based panel that monitor the chiller’s operation, protects it from damage, provides the operator with data and diagnostic messages, and permits interfacing with a building automation system.

direct expansion (DX) shell-and-tube evaporator A type of evaporator where refrigerant flows through the tubes and water fills the surrounding shell.

electronic expansion valve A type of expansion device that uses an electronically-actuated valve to sense and control the flow rate of liquid refrigerant to the evaporator.

enthalpy The property of a refrigerant indicating its total heat content, both sensible and latent.

evaporator The region of the chiller where the system chilled water is continuously cooled by flashing the refrigerant to vapor as it picks up heat from the returning chilled water.

expansion device The component of the chiller used to reduce the pressure and temperature of the refrigerant.

flooded shell-and-tube evaporator A type of evaporator where water flows through the tubes and refrigerant fills the surrounding shell.

liquid/vapor separator The component of the chiller used to remove vapor from the refrigerant mixture after it passes through the expansion device. This

Glossary

vapor is directed back to the compressor while the liquid refrigerant travels on to the evaporator.

oil separator The component of the chiller used to remove oil from the refrigerant vapor after it is discharged from the compressor. This oil is directed back to the compressor.

orifice plate A type of expansion device that uses a fixed plate with holes drilled in it to meter the flow rate of refrigerant to the evaporator.

ported compressors A type of compressor where the refrigerant vapor enters and exits through ports—no valves are used.

pressure-enthalpy diagram A graphical representation of the saturated properties of a refrigerant, plotting refrigerant pressure versus enthalpy.

rotor The part of the helical-rotary compressor used to trap and compress the refrigerant vapor. The male and female rotors mesh together forming pockets of refrigerant to move through the compressor.

slide valve The part of the helical-rotary compressor used to vary the flow rate of refrigerant vapor through it.

subcooler The lower portion of the condenser that further cools the saturated liquid refrigerant.

water-cooled condenser A type of condenser that rejects the heat of the refrigerant to water flowing through it.



Trane optimizes the performance of homes and buildings around the world. A business of Ingersoll Rand, the leader in creating and sustaining safe, comfortable and energy efficient environments, Trane offers a broad portfolio of advanced controls and HVAC systems, comprehensive building services, and parts. For more information, visit www.Trane.com.

Trane has a policy of continuous product and product data improvement and reserves the right to change design and specifications without notice.

© 2012 Trane All rights reserved
TRG-TRC012-EN 31 July 2012
Supersedes TRG-TRC012-EN (26 Aug 1999)

We are committed to using environmentally
conscious print practices that reduce waste.

