

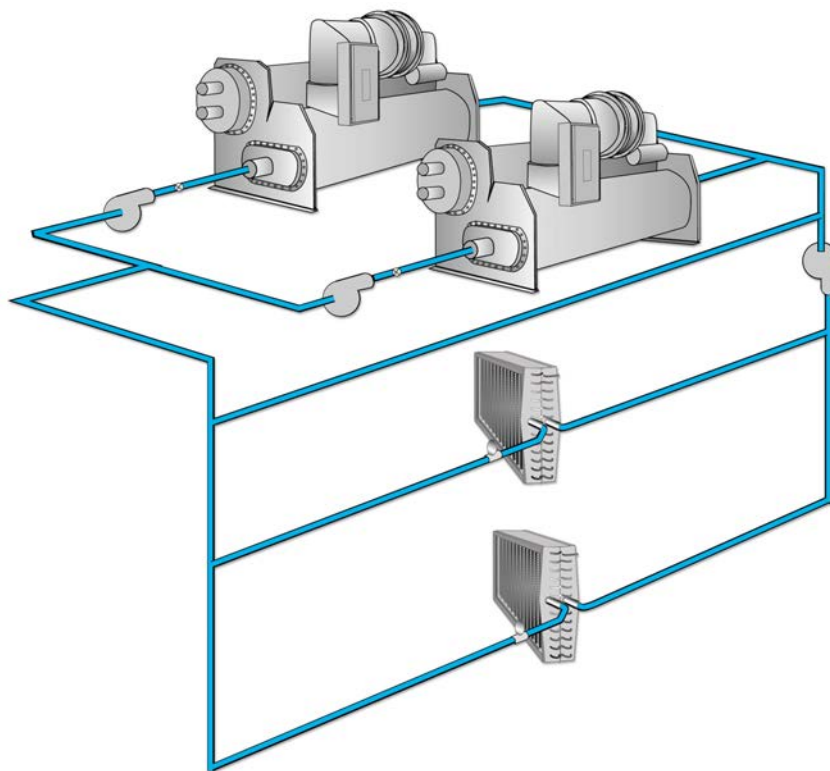

Air Conditioning Clinic

Chilled-Water Systems

One of the Systems Series





Chilled-Water Systems

One of the Systems Series

A publication of Trane

Preface

Chilled-Water Systems

A Trane Air Conditioning Clinic

Figure 1

Trane believes that it is incumbent on manufacturers to serve the industry by regularly disseminating information gathered through laboratory research, testing programs, and field experience.

The Trane Air Conditioning Clinic series is one means of knowledge sharing. It is intended to acquaint a nontechnical audience with various fundamental aspects of heating, ventilating, and air conditioning. We have taken special care to make the clinic as uncommercial and straightforward as possible. Illustrations of Trane products only appear in cases where they help convey the message contained in the accompanying text.

This particular clinic introduces the reader to **chilled-water systems**.

Contents

period one	Types of Water Chillers	1
	Vapor-Compression Water Chillers	3
	Air-Cooled or Water-Cooled Condensing	6
	Packaged or Split Components	11
	Absorption Water Chillers	15
	Equipment Rating Standards	18
period two	Chilled-Water System Design	26
	Load-Terminal Control	28
	Parallel Configuration	35
	Series Configuration	38
	Primary-Secondary System Operation	53
period three	System Variations	59
	Alternate Fuel Choice	59
	Low-Flow Systems	61
	Variable-Primary-Flow Systems	64
	Preferential Loading	66
	Heat Recovery	68
	Asymmetric Design	72
	“Free” Cooling	75
	Application Outside the Operating Range of the Chiller	78
period four	Chiller-Plant Control	79
	Chiller Sequencing	82
	Failure Recovery and Contingency Planning	90
	System Tuning	92
	System Optimization	96
	Operator Interface	100
period five	Review	103
	Quiz	108
	Answers	110
	Glossary	112



period one

Types of Water Chillers

notes

Chilled-Water Systems

period one

Types of Water Chillers

Figure 2

Water chillers are used in a variety of air conditioning and process cooling applications. They cool water that is subsequently transported by pumps and pipes. The water passes through the tubes of coils to cool air in an air conditioning system, or it can provide cooling for a manufacturing or industrial process. Systems that employ water chillers are commonly called **chilled-water systems**.

When designing a chilled-water system, one of the first issues that must be addressed is to determine which type of water chiller to use. This period discusses the primary differences in chiller types.

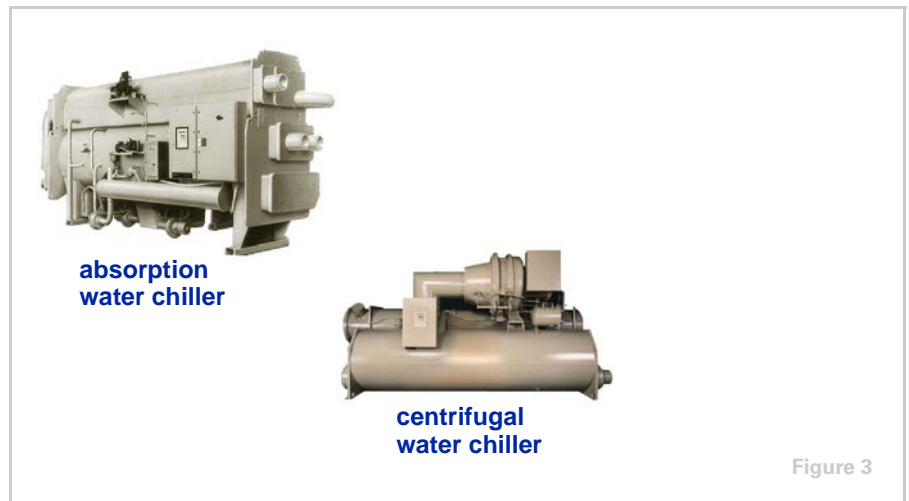

The refrigeration cycle is a key differentiating characteristic between chiller types. The vapor-compression and absorption refrigeration cycles are the two most common cycles used in commercial air conditioning.

period one

Types of Water Chillers

notes

Water chillers using the vapor-compression refrigeration cycle vary by the type of compressor used. Reciprocating, scroll, helical-rotary, and centrifugal compressors are common types of compressors used in vapor-compression water chillers.

Absorption water chillers make use of the absorption refrigeration cycle.



Vapor-compression water chillers use a compressor to move refrigerant around the system. The most common energy source to drive the compressor is an electric motor.

Absorption water chillers use heat to drive the refrigeration cycle. They do not have a mechanical compressor involved in the refrigeration cycle. Steam, hot water, or the burning of oil or natural gas are the most common energy sources for these types of chillers.

period one

Types of Water Chillers

notes

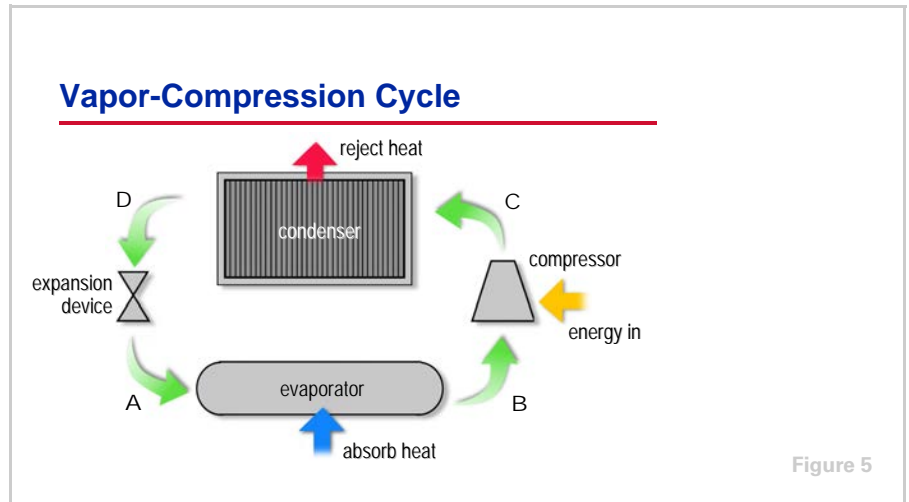

Vapor-Compression Water Chillers

In the vapor-compression refrigeration cycle, refrigerant enters the evaporator in the form of a cool, low-pressure mixture of liquid and vapor (**A**). Heat is transferred from the relatively-warm air or water to the refrigerant, causing the liquid refrigerant to boil. The resulting vapor (**B**) is then drawn from the evaporator by the compressor, which increases the pressure and temperature of the refrigerant vapor.

The hot, high-pressure refrigerant vapor (**C**) leaving the compressor enters the condenser, where heat is transferred to ambient air or water at a lower temperature. Inside the condenser, the refrigerant vapor condenses into a liquid. This liquid refrigerant (**D**) then flows to the expansion device, which creates a pressure drop that reduces the pressure of the refrigerant to that of the evaporator. At this low pressure, a small portion of the refrigerant boils (or flashes), cooling the remaining liquid refrigerant to the desired evaporator temperature. The cool mixture of liquid and vapor refrigerant (**A**) travels to the evaporator to repeat the cycle.

The vapor-compression refrigeration cycle is reviewed in detail in the *Refrigeration Cycle Air Conditioning Clinic*.

period one

Types of Water Chillers

notes

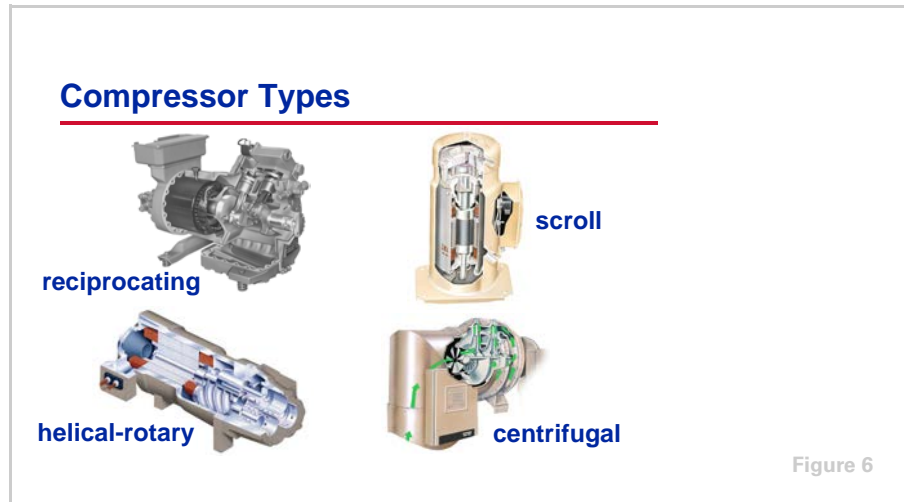

The type of compressor used generally has the greatest impact on the efficiency and reliability of a vapor-compression water chiller. The improvement of compressor designs and the development of new compressor technologies have led to more-efficient and -reliable water chillers.

The **reciprocating compressor** was the workhorse of the small chiller market for many years. It was typically available in capacities up to 100 tons [350 kW]. Multiple compressors were often installed in a single chiller to provide chiller capacities of up to 200 tons [700 kW].

Scroll compressors have emerged as a popular alternative to reciprocating compressors, and are generally available in hermetic configurations in capacities up to 15 tons [53 kW] for use in water chillers. As with reciprocating compressors, multiple scroll compressors are often used in a single chiller to meet larger capacities. In general, scroll compressors are 10 to 15 percent more efficient than reciprocating compressors and have proven to be very reliable, primarily because they have approximately 60 percent fewer moving parts than reciprocating compressors. Reciprocating and scroll compressors are typically used in smaller water chillers, those less than 200 tons [700 kW].

Helical-rotary (or screw) compressors have been used for many years in air compression and low-temperature-refrigeration applications. They are now widely used in medium-sized water chillers, 50 to 500 tons [175 to 1,750 kW]. Like the scroll compressor, helical-rotary compressors have a reliability advantage due to fewer moving parts, as well as better efficiency than reciprocating compressors.

Centrifugal compressors have long been used in larger water chillers. High efficiency, superior reliability, reduced sound levels, and relatively low cost have contributed to the popularity of the centrifugal chiller. Centrifugal compressors are generally available in prefabricated chillers from 100 to 3,000 tons [350 to 10,500 kW], and up to 8,500 tons [30,000 kW] as built-up machines.

period one

Types of Water Chillers

notes

These various types of compressors are discussed in detail in the *Refrigeration Compressors Air Conditioning Clinic*.

Variable-Speed Drives



Figure 7

The capacity of a centrifugal chiller can be modulated using inlet guide vanes (IGV) or a combination of IGV and a variable-speed drive (adjustable-frequency drive, AFD). Variable-speed drives are widely used with fans and pumps, and as a result of the advancement of microprocessor-based controls for chillers, they are now being applied to centrifugal water chillers.

Using an AFD with a centrifugal chiller will degrade the chiller's full-load efficiency. This can cause an increase in electricity demand or real-time pricing charges. At the time of peak cooling, such charges can be ten (or more) times the non-peak charges. Alternatively, an AFD can offer energy savings by reducing motor speed at low-load conditions, when cooler condenser water is available. An AFD also controls the inrush current at start-up.

Certain system characteristics favor the application of an adjustable-frequency drive, including:

- A substantial number of part-load operating hours
- The availability of cooler condenser water
- Chilled-water reset control

Chiller savings using condenser- and chilled-water-temperature reset, however, should be balanced against the increase in pumping and cooling-tower energy. This is discussed in Period Four. Performing a comprehensive energy analysis is the best method of determining whether an adjustable-frequency drive is desirable. It is important to use actual utility costs, not a "combined" cost, for demand and consumption charges.

Depending on the application, it may make sense to use the additional money that would be needed to purchase an AFD to purchase a more efficient chiller instead. This is especially true if demand charges are significant.

period one

Types of Water Chillers

notes

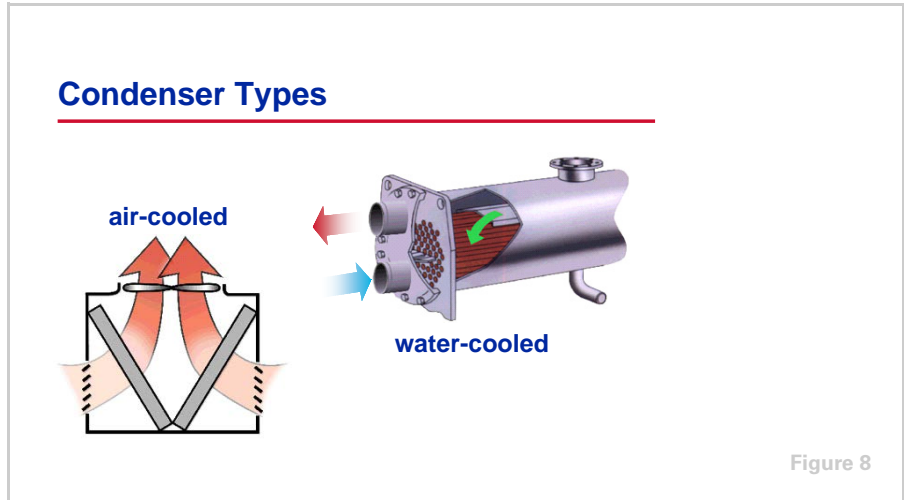

Air-Cooled or Water-Cooled Condensing

The heat exchangers in the water chiller (the condenser and evaporator) have the second greatest impact on chiller efficiency and cost. One of the most distinctive differences in chiller heat exchangers continues to be the type of condenser selected—air-cooled versus water-cooled.

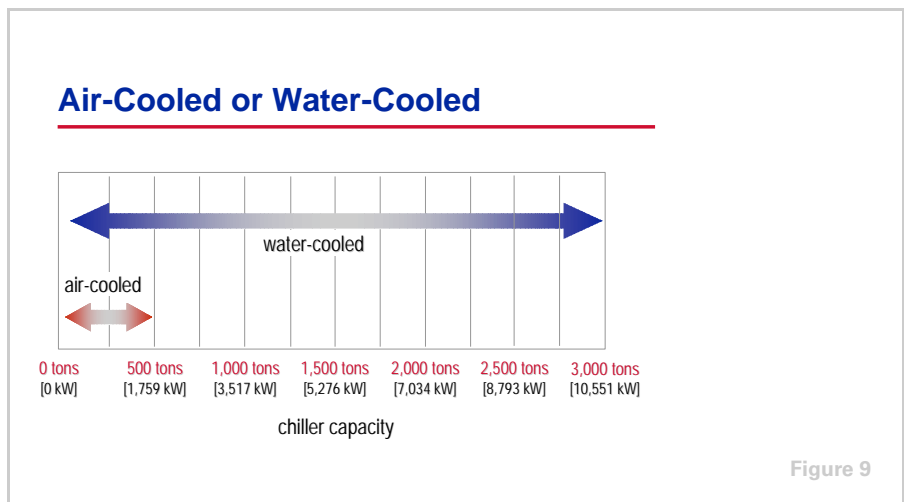

When comparing air-cooled and water-cooled chillers, available capacity is the first distinguishing characteristic. Air-cooled chillers are typically available in packaged chillers ranging from 7.5 to 500 tons [25 to 1,580 kW]. Packaged water-cooled chillers are typically available from 10 to 3,000 tons [35 to 10,500 kW].

period one

Types of Water Chillers

notes

air-cooled or water-cooled

Maintenance

- Water treatment
- Condenser tube brushing
- Tower maintenance
- Freeze protection
- Makeup water

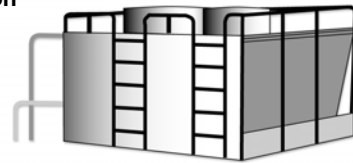

cooling tower

Figure 10

A major advantage of using an air-cooled chiller is the elimination of the cooling tower. This eliminates the concerns and maintenance requirements associated with water treatment, chiller condenser-tube cleaning, tower mechanical maintenance, freeze protection, and the availability and quality of makeup water. This reduced maintenance requirement is particularly attractive to building owners because it can substantially reduce operating costs.

Systems that use an open cooling tower must have a water treatment program. Lack of tower-water treatment results in contaminants such as bacteria and algae. Fouled or corroded tubes can reduce chiller efficiency and lead to premature equipment failure.

period one

Types of Water Chillers

notes



Air-cooled chillers are often selected for use in systems that require year-round cooling requirements that cannot be met with an airside economizer. Air-cooled condensers have the ability to operate in below-freezing weather, and can do so without the problems associated with operating the cooling tower in these conditions. Cooling towers may require special control sequences, basin heaters, or even an indoor sump for safe operation in freezing weather.

For process applications, such as computer centers that require cooling year-round, this ability alone often dictates the use of air-cooled chillers.

period one

Types of Water Chillers

notes

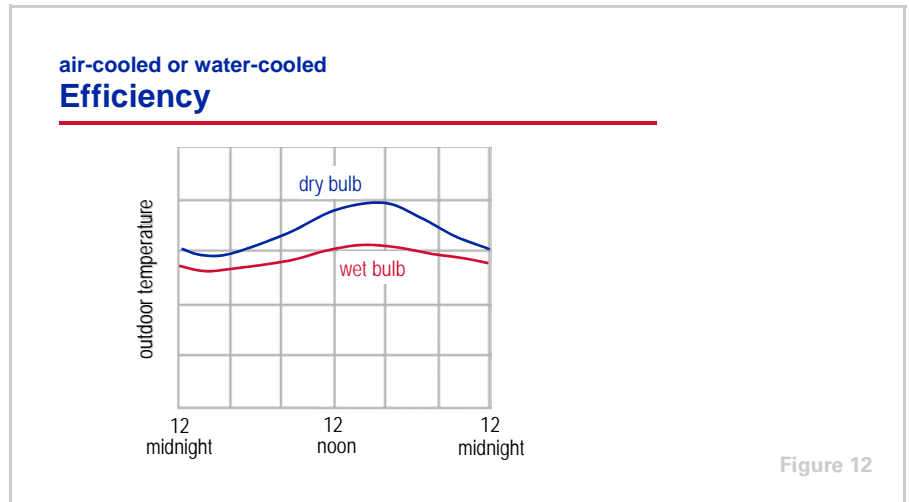

Water-cooled chillers are typically more energy efficient than air-cooled chillers. The refrigerant condensing temperature in an air-cooled chiller is dependent on the ambient dry-bulb temperature. The condensing temperature in a water-cooled chiller is dependent on the condenser-water temperature, which is dependent on the ambient wet-bulb temperature. Since the wet-bulb temperature is often significantly lower than the dry-bulb temperature, the refrigerant condensing temperature (and pressure) in a water-cooled chiller can be lower than in an air-cooled chiller. For example, at an outdoor design condition of 95°F [35°C] dry-bulb temperature, 78°F [25.6°C] wet-bulb temperature, a cooling tower delivers 85°F [29.4°C] water to the water-cooled condenser. This results in a refrigerant condensing temperature of approximately 100°F [37.8°C]. At these same outdoor conditions, the refrigerant condensing temperature in an air-cooled condenser is approximately 125°F [51.7°C]. A lower condensing temperature, and therefore a lower condensing pressure, means that the compressor needs to do less work and consumes less energy.

This efficiency advantage may lessen at part-load conditions because the dry-bulb temperature tends to drop faster than the wet-bulb temperature (see Figure 12). As a result, the air-cooled chiller may benefit from greater condenser relief.

Additionally, the efficiency advantage of a water-cooled chiller is much less when the additional cooling tower and condenser pump energy costs are considered. Performing a comprehensive energy analysis is the best method of estimating the operating-cost difference between air-cooled and water-cooled systems.

period one

Types of Water Chillers

notes

**air-cooled or water-cooled
Comparison**

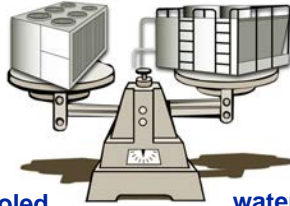

air-cooled	water-cooled
<ul style="list-style-type: none">• Lower maintenance• Packaged system• Better low-ambient operation	<ul style="list-style-type: none">• Greater energy efficiency• Longer equipment life

Figure 13

Another advantage of an air-cooled chiller is its delivery as a “packaged system.” Reduced design time, simplified installation, higher reliability, and single-source responsibility are all factors that make the factory packaging of the condenser, compressor, and evaporator a major benefit. A water-cooled chiller has the additional requirements of condenser-water piping, pump, cooling tower, and associated controls.

Water-cooled chillers typically last longer than air-cooled chillers. This difference is due to the fact that the air-cooled chiller is installed outdoors, whereas the water-cooled chiller is installed indoors. Also, using water as the condensing fluid allows the water-cooled chiller to operate at lower pressures than the air-cooled chiller. In general, air-cooled chillers last 15 to 20 years, while water-cooled chillers last 20 to 30 years.

To summarize the comparison of air-cooled and water-cooled chillers, air-cooled chiller advantages include lower maintenance costs, a prepackaged system for easier design and installation, and better low-ambient operation. Water-cooled chiller advantages include greater energy efficiency (at least at design conditions) and longer equipment life.

period one

Types of Water Chillers

notes

Packaged Air-Cooled Chiller

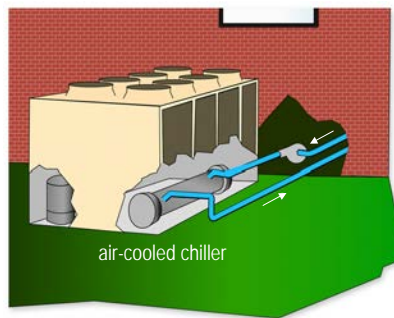

Figure 14

Packaged or Split Components

Water-cooled chillers are rarely installed with separable components. Air-cooled chillers, however, offer the flexibility of separating the components in different physical locations. This flexibility allows the system design engineer to place the components where they best serve the available space, acoustic, and maintenance requirements of the customer.

A packaged air-cooled chiller has all of the refrigeration components (compressor, condenser, expansion device, and evaporator) located outdoors. A major advantage of this configuration is factory assembly and testing of all chiller components, including the wiring, refrigerant piping, and controls.

This eliminates field labor and often results in faster installation and improved system reliability. Additionally, all noise-generating components (compressors and condenser fans) are located outdoors, easing indoor noise concerns. Finally, indoor equipment-room space requirements are minimized.

period one

Types of Water Chillers

notes

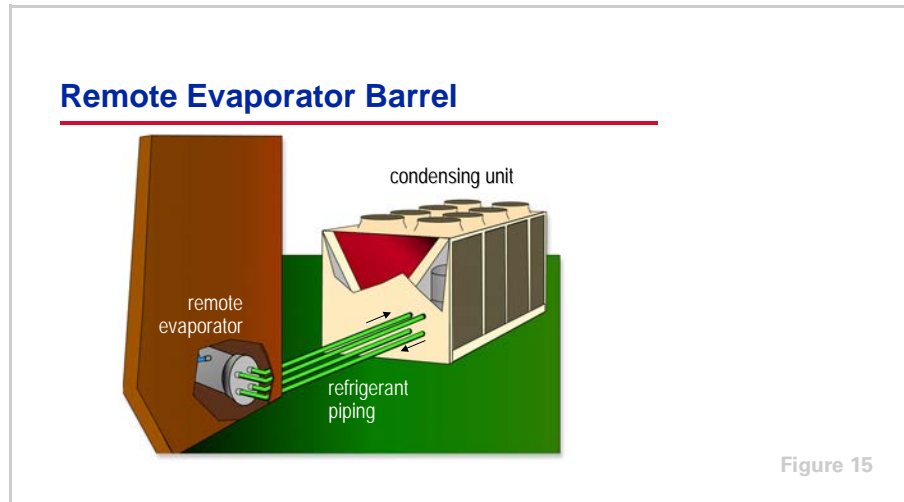

An alternative to the packaged air-cooled chiller is to use a packaged condensing unit (condenser and compressor) located outdoors, with a remote evaporator barrel located in the indoor equipment room. The two components are connected with field-installed refrigerant piping. This configuration locates the part of the system that is susceptible to freezing (evaporator) indoors and the noise-generating components (compressors and condenser fans) outdoors. This usually eliminates any requirement to protect the chilled-water loop from freezing during cold weather.

This configuration is particularly popular in schools and other institutional applications, primarily due to reduced seasonal maintenance for freeze protection. A drawback of splitting the components is the requirement for field-installed refrigerant piping. The possibility of system contamination and leaks increases when field-installed piping and brazing are required. Additionally, longer design time is generally required for the proper selection, sizing, and installation of this split system.

period one

Types of Water Chillers

notes

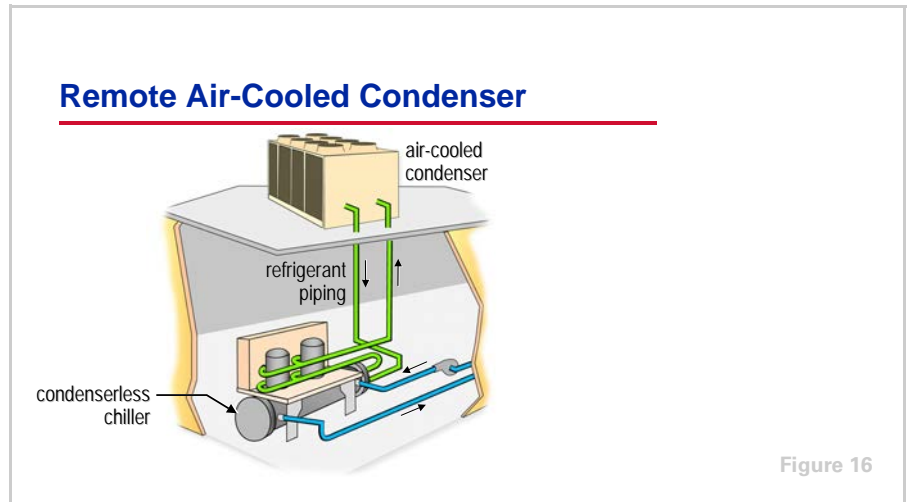

Another popular configuration is to use an outdoor air-cooled condenser connected to a packaged compressor and evaporator unit (also called a condenserless chiller) that is located in the indoor equipment room. Again, the components are connected with field-installed refrigerant piping.

The primary advantage of this configuration is that the compressors are located indoors, which makes maintenance easier during inclement weather and virtually eliminates the concern of refrigerant migrating to the compressors during cold weather.

period one
Types of Water Chillers

notes

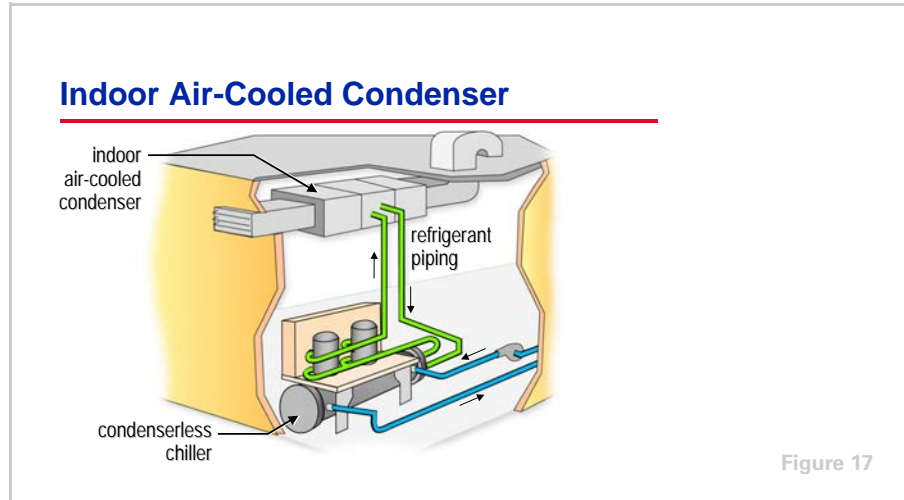

The final configuration includes a packaged compressor-and-evaporator unit that is located in an indoor equipment room and connected to an indoor, air-cooled condenser. The air used for condensing is ducted from outdoors, through the condenser coil, and rejected either outdoors or inside the building as a means for heat recovery. Indoor condensers typically use a centrifugal fan to overcome the duct static-pressure losses, rather than the propeller fans used in conventional outdoor air-cooled condensers. Again, the components are connected with field-installed refrigerant piping.

This configuration is typically used where an outdoor condenser is architecturally undesirable, where the system is located on a middle floor of a multistory building, or where vandalism to exterior equipment is a problem. A disadvantage of this configuration is that it typically increases condenser fan energy within compared to a conventional outdoor air-cooled condenser.

Similarly, a packaged cooling tower in a water-cooled system can also be located indoors. This configuration also requires outdoor air to be ducted to and from the cooling tower, and again, typically requires the use of a centrifugal fan. Centrifugal fans use about twice as much energy as a propeller fan, but can overcome the static-pressure losses due to the ductwork. Alternatively, the tower sump can be located indoors, making freeze protection easier.

period one

Types of Water Chillers

notes

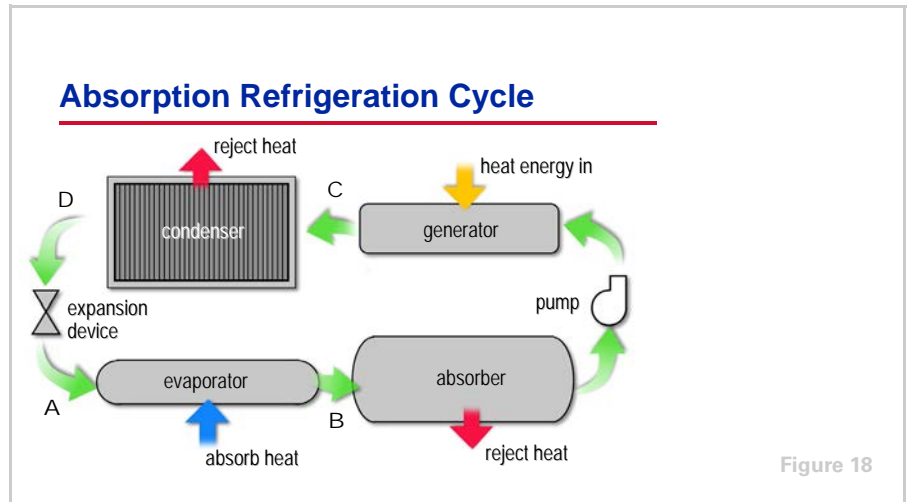

Absorption Water Chillers

So far, we have discussed water chillers that use the vapor-compression refrigeration cycle. Absorption water chillers are a proven alternative to vapor-compression chillers. The absorption refrigeration cycle uses heat energy as the primary driving force. The heat may be supplied either in the form of steam or hot water (indirect-fired), or by burning oil or natural gas (direct-fired).

There are two fundamental differences between the absorption refrigeration cycle and the vapor-compression refrigeration cycle. The first is that the compressor is replaced by an absorber, pump, and generator. The second is that, in addition to the refrigerant, the absorption refrigeration cycle uses a secondary fluid called the absorbent. The condenser, expansion device, and evaporator sections, however, are similar.

Warm, high-pressure liquid refrigerant (**D**) passes through the expansion device and enters the evaporator in the form of a cool, low-pressure mixture of liquid and vapor (**A**). Heat is transferred from the relatively-warm system water to the refrigerant, causing the liquid refrigerant to boil. Using an analogy of the vapor-compression cycle, the absorber acts like the suction side of the compressor—it draws in the refrigerant vapor (**B**) to mix with the absorbent. The pump acts like the compression process itself—it pushes the mixture of refrigerant and absorbent up to the high-pressure side of the system. The generator acts like the discharge of the compressor—it delivers the refrigerant vapor (**C**) to the rest of the system.

The refrigerant vapor (**C**) leaving the generator enters the condenser, where heat is transferred to cooling-tower water at a lower temperature, causing the refrigerant vapor to condense into a liquid. This high-pressure liquid refrigerant (**D**) then flows to the expansion device, which creates a pressure drop that reduces the pressure of the refrigerant to that of the evaporator, repeating the cycle.

The absorption refrigeration cycle is discussed in more detail in the *Absorption Water Chillers Air Conditioning Clinic*.

period one
Types of Water Chillers

notes

Absorption Chillers Offer Choice

- Avoid high electric demand charges
- Minimal electricity needed during emergency situations
- Waste heat recovery
- Cogeneration



Figure 19

Absorption water chillers generally have a higher first cost than vapor-compression chillers. The cost difference is due to the additional heat-transfer tubes required in the absorber and generator(s), the solution heat exchangers, and the cost of the absorbent. This initial cost premium is often justified when electric demand charges or real-time electricity prices are a significant portion of the electric utility bill. Because electric demand charges are often highest at the same time as peak cooling requirements, absorption chillers are often selected as peaking or demand-limiting chillers.

Because the absorption chiller uses only a small amount of electricity, backup-generator capacity requirements may be significantly lower with absorption chillers than with electrically-driven chillers. This makes absorption chillers attractive in applications requiring emergency cooling, assuming the alternate energy source is available.

Some facilities, such as hospitals or factories, may have excess steam or hot water as a result of normal operations. Other processes, such as a gas turbine, generate waste steam or some other waste gas that can be burned. In such applications, this otherwise wasted energy can be used to fuel an absorption chiller.

Finally, cogeneration systems often use absorption chillers as a part of their total energy approach to supplying electricity in addition to comfort cooling and heating.

period one

Types of Water Chillers

notes

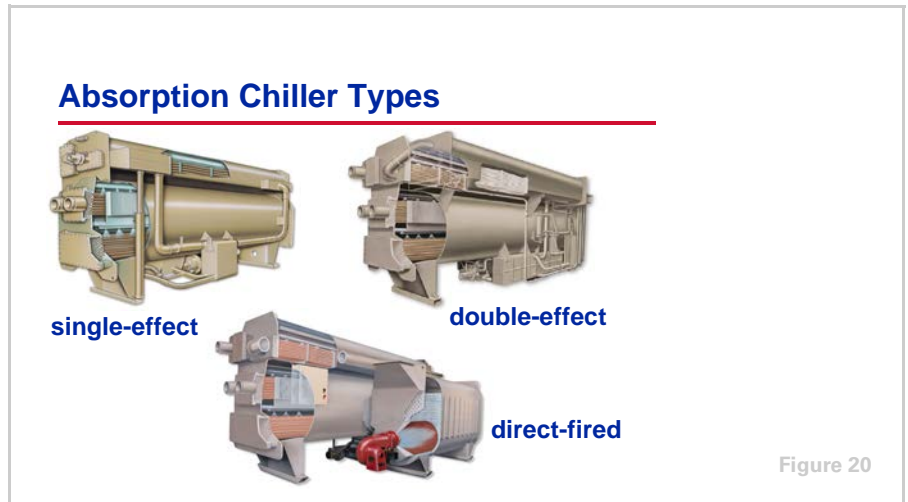

Figure 20

There are three basic types of absorption chillers. They are typically available in capacities ranging from 100 to 1,600 tons [350 to 5,600 kW].

Indirect-fired, **single-effect absorption chillers** operate on low-pressure steam (approximately 15 psig [205 kPa]) or medium-temperature liquids (approximately 270°F [132°C]), and have a coefficient of performance (COP) of 0.6 to 0.8. In many applications, waste heat from process loads, cogeneration plants, or excess boiler capacity provides the steam to drive a single-effect chiller. In these applications, absorption chillers become conservation devices and are typically base-loaded. This means that they run as the lead chiller to make use of the “free” energy that might otherwise be wasted.

Indirect-fired, **double-effect absorption chillers** require medium-pressure steam (approximately 115 psig [894 kPa]) or high-temperature liquids (approximately 370°F [188°C]) to operate and, therefore, typically require dedicated boilers. Typical COPs for these chillers are 0.9 to 1.2.

The **direct-fired absorption chiller** includes an integral burner, rather than relying on an external heat source. Common fuels used to fire the burner are natural gas, fuel oil, or liquid petroleum. Additionally, combination burners are available that can switch from one fuel to another. Typical COPs for direct-fired, double-effect chillers are 0.9 to 1.1 (based on the higher heating value of the fuel). Higher energy efficiency and elimination of the boiler are largely responsible for the increasing interest in direct-fired absorption chillers. These types of absorption chillers have the added capability to produce hot water for heating. Thus, these “chiller-heaters” can be configured to produce both chilled water and hot water simultaneously. In certain applications this flexibility eliminates, or significantly down-sizes, the boilers.

period one

Types of Water Chillers

notes

Equipment Rating Standards

- **Air-Conditioning & Refrigeration Institute (ARI)**

- ◆ Standard 550/590–1998: centrifugal and helical-rotary water chillers
- ◆ Standard 560–1992: absorption water chillers



Figure 21

Equipment Rating Standards

The Air-Conditioning & Refrigeration Institute (ARI) establishes rating standards for packaged HVAC equipment. ARI also certifies and labels equipment through programs that involve random testing of a manufacturer’s equipment to verify published performance. These equipment rating standards have been developed to aid engineers in comparing similar equipment from different manufacturers. Chiller full-load efficiency is described in terms of kW/ton and coefficient of performance (COP). Additionally, two efficiency values developed by ARI that are receiving increased attention are the **Integrated Part-Load Value (IPLV)** and **Non-Standard Part-Load Value (NPLV)**.

ARI’s part-load efficiency rating system establishes a single number to estimate both the full- and part-load performance of a stand-alone chiller. As part of ARI Standard 550/590–1998, *Water-Chilling Packages Using the Vapor-Compression Refrigeration Cycle*, and ARI Standard 560–1992, *Absorption Water Chilling-Heating Packages*, chiller manufacturers may now certify their chiller part-load performance using the IPLV and NPLV methods. This gives the engineering community an easy and certified method to evaluate individual chillers. Understanding the scope and application limits of IPLV and NPLV is, however, crucial to their validity as system performance indicators.

period one

Types of Water Chillers

notes

Part-Load Efficiency Rating

- **Integrated Part-Load Value (IPLV)**
 - ◆ Weighted-average load curves
 - ◆ Based on an “average” single-chiller installation
 - ◆ Standard operating conditions
- **Non-Standard Part-Load Value (NPLV)**
 - ◆ Weighted-average load curves
 - ◆ Based on an “average” single-chiller installation
 - ◆ Non-standard operating conditions

Figure 22

The IPLV predicts chiller efficiency at the ARI standard rating conditions, using weighted-average load curves that represent a broad range of geographic locations, building types, and operating-hour scenarios, both with and without an airside economizer. The NPLV uses the same methods to predict chiller efficiency at non-standard rating conditions. Although these weighted-average load curves place greater emphasis on the part-load operation of an average, single-chiller installation, they will not—by definition—represent any particular installation.

Additionally, ARI notes that more than 80 percent of all chillers are installed in multiple-chiller systems. Chillers in these systems exhibit different unloading characteristics than the IPLV weighted formula indicates. Appendix D of Standard 550/590–1998 explains this further:

The IPLV equations and procedure are intended to provide a single-number, part-load performance number for water-chilling products. The equation was derived to provide a representation of the average part-load efficiency for a single chiller only. However, it is best to use a comprehensive analysis that reflects the actual weather data, building load characteristics, operational hours, economizer capabilities, and energy drawn by auxiliaries, such as pumps and cooling towers, when calculating the chiller and system efficiency.

Here is the important part:

This becomes increasingly important with multiple-chiller systems because individual chillers operating within multiple-chiller systems are more heavily loaded than single chillers within single-chiller systems.

period one

Types of Water Chillers

notes

Standard Rating Conditions

chiller type	evaporator flow rate	condenser flow rate	rating standard
vapor-compression			
<ul style="list-style-type: none"> • reciprocating • scroll • helical-rotary • centrifugal 	2.4 gpm/ton [0.043 L/s/kW]	3.0 gpm/ton [0.054 L/s/kW]	ARI 550/590–1998
absorption			
<ul style="list-style-type: none"> • single-effect 	2.4 gpm/ton [0.043 L/s/kW]	3.6 gpm/ton [0.065 L/s/kW]	
<ul style="list-style-type: none"> • double-effect, indirect-fired 	2.4 gpm/ton [0.043 L/s/kW]	4.0 gpm/ton [0.072 L/s/kW]	ARI 560–1992
<ul style="list-style-type: none"> • double-effect, direct-fired 		4.5 gpm/ton [0.081 L/s/kW]	

water leaving evaporator = 44°F [6.7°C]
water entering condenser = 85°F [29.4°C]

Figure 23

The standard rating conditions used for ARI certification represent a particular set of design temperatures and flow rates for which water-cooled and air-cooled systems may be designed. They are not suggestions for good design practice for a given system—they simply define a common rating point to aid comparisons.

In fact, concerns toward improved humidity control and energy efficiency have changed some of the design trends for specific applications. More commonly, chilled-water systems are being designed with lower chilled-water temperatures and lower flow rates. The water flow rate required through the system is decreased by allowing a larger temperature difference through the chiller.

period one

Types of Water Chillers

notes

Flow Rates and Temperatures

$$Q_{\text{Btu/hr}} = 500 \times \text{flow rate} \times \Delta T$$

$$[Q_w = 4,184 \times \text{flow rate} \times \Delta T]$$

equation for water only

Figure 24

The temperature difference (ΔT) through the chiller and the water flow rate are related. For a given load, as the flow rate is reduced, the ΔT increases, and vice versa.

$$Q = 500 \times \text{flow rate} \times \Delta T$$

$$[Q = 4,184 \times \text{flow rate} \times \Delta T]$$

where,

- Q = load, Btu/hr [W]
- flow rate = water flow rate through the chiller, gpm [L/s]
- ΔT = temperature difference (leaving minus entering) through the chiller, °F [°C]

Realize that 500 [4,184] is not a constant! It is the product of density, specific heat, and a conversion factor for time. The properties of water at conditions typically found in an HVAC system result in this value. Other fluids, such as mixtures of water and antifreeze, will cause this factor to change.

Density of water = 8.33 lb/gal [1.0 kg/L]

Specific heat of water = 1.0 Btu/lb°F [4,184 J/kg°K]

$$8.33 \text{ lb/gal} \times 1.0 \text{ Btu/lb}^\circ\text{F} \times 60 \text{ min/hr} = 500$$

$$[1.0 \text{ kg/L} \times 4,184 \text{ J/kg}^\circ\text{K} = 4,184]$$

period one

Types of Water Chillers

notes

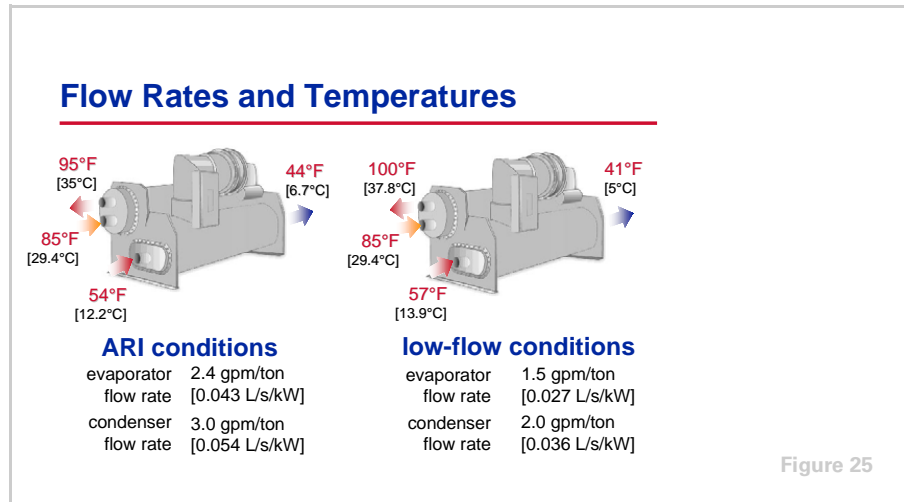

In the example system shown in Figure 25, the chilled water is cooled from 57°F [13.9°C] to 41°F [5°C] for a 16°F [8.9°C] ΔT . This reduces the water flow rate required from 2.4 gpm/ton [0.043 L/s/kW] to 1.5 gpm/ton [0.027 L/s/kW].

Reducing water flow rates either: 1) lowers system installed costs by reducing pipe, pump, valve, and cooling tower sizes, or 2) lowers system operating costs by using smaller pumps and smaller cooling tower fans. In some cases, both installed and operating costs can be saved. Low-flow systems will be discussed in more detail in Period Three.

The two ARI rating standards mentioned previously, as well as ASHRAE/IESNA Standard 90.1–1999 (the energy standard), allow reduced chilled-water temperatures and flow rates. System design engineers should examine the use of reduced flow rates to offer value to building owners.

period one

Types of Water Chillers

notes

ASHRAE/IESNA Standard 90.1–1999

- **Energy Standard**
 - ◆ Building design and materials
 - ◆ Minimum equipment efficiencies
 - ◆ HVAC system design



Figure 26

ASHRAE/IESNA Standard 90.1–1999, *Energy Standard for Buildings, Except Low-Rise Residential Buildings*, went into effect in October 1999. ASHRAE is the American Society of Heating, Refrigerating and Air-Conditioning Engineers and IESNA is the Illuminating Engineering Society of North America. This standard addresses all aspects of buildings except low-rise residential buildings. It contains specific requirements for both water chillers and chilled-water systems.

standard 90.1-1999 efficiency requirements Electric Vapor-Compression Chillers

chiller type	capacity	minimum efficiency*	
air cooled	all capacities	2.8 COP	3.05 IPLV
water-cooled reciprocating	all capacities	4.2 COP	5.05 IPLV
helical-rotary, scroll	< 150 tons [528 kW]	4.45 COP	5.2 IPLV
	150 to 300 tons [528 to 1,056 kW]	4.9 COP	5.6 IPLV
	> 300 tons [1,056 kW]	5.5 COP	6.15 IPLV
centrifugal	< 150 tons [528 kW]	5.0 COP	5.25 IPLV
	150 to 300 tons [528 to 1,056 kW]	5.55 COP	5.9 IPLV
	> 300 tons [1,056 kW]	6.1 COP	6.4 IPLV

* as of October 29, 2001

Figure 27

Standard 90.1 contains minimum full- and part-load efficiency requirements for packaged water chillers. The table in Figure 27 is an excerpt from Table 6.2.1C of Addendum J to the standard. It includes the minimum efficiency requirements for electric vapor-compression chillers operating at standard ARI conditions. The standard also contains tables of minimum efficiency requirements for these chillers operating at nonstandard conditions. The test procedure for these chillers is ARI Standard 550/590–1999. Notice that these requirements go into effect on October 29, 2001.

period one

Types of Water Chillers

notes

Note: Addendum J updates the minimum IPLV efficiency requirements in the standard to match the methods included in the most current version of the ARI rating standard. At the time this booklet was printed, Addendum J had not been formally adopted as part of the standard. However, its adoption was deemed sure enough to include in this publication.

The standard requires that both full- and part-load conditions be met. For example, the efficiency of a water-cooled centrifugal chiller with a capacity greater than 300 tons [1,056 kW] must be 6.1 COP, or better, at ARI standard conditions. This is equivalent to 0.576 kW/ton. The part-load (IPLV) efficiency must also be 6.4 (based on the efficiency units of COP) or better. This is equivalent to an IPLV of 0.549 kW/ton.

Coefficient of performance (COP) is a unitless expression of efficiency, defined as useful energy out divided by energy input. A higher COP designates a higher efficiency.

$$\text{kW/ton} = \frac{3.516}{\text{COP}}$$

standard 90.1-1999 efficiency requirements
Water-Cooled Absorption Chillers

chiller type	capacity	minimum efficiency*
single-effect	all capacities	0.7 COP
double-effect indirect-fired	all capacities	1.0 COP 1.05 IPLV
direct-fired	all capacities	1.0 COP 1.0 IPLV

* as of October 29, 2001

Figure 28

The table in Figure 28 includes the minimum efficiency requirements for absorption water chillers. For an absorption chiller, COP is defined as evaporator cooling capacity divided by the heat energy required by the generator, excluding the electrical energy needed to operate the pumps, purge, and controls.

Again, these minimum efficiency requirements take effect on October 29, 2001. The test procedure for these chillers is ARI Standard 560–1992. Note that the efficiency requirement for single-effect absorption chillers is higher than many manufacturers have offered in the past.

Section 6.3.4 of Standard 90.1 includes additional requirements for the design and operation of chilled-water systems. These requirements will be mentioned in later periods.

period one

Types of Water Chillers

notes

ASHRAE Standard 15–1994

- Safety standard for refrigerating systems
- Mechanical equipment room
 - ◆ Refrigerant monitors
 - ◆ Alarms
 - ◆ Mechanical ventilation
 - ◆ Pressure-relief piping

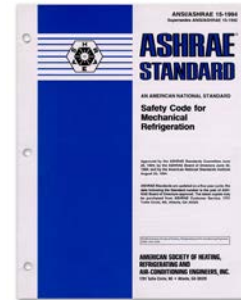

Figure 29

Another standard that is related to chilled-water systems, ASHRAE Standard 15–1994, *Safety Code for Mechanical Refrigeration*, is intended to specify requirements for safe design, construction, installation, and operation of refrigerating systems. This standard covers mechanical refrigeration systems of all sizes that use all types of refrigerants. Because absorption chillers use water as the refrigerant, however, they are exempt from this standard.

For many chilled-water systems in which the chillers are located indoors, the standard requires the refrigeration equipment to be installed in a mechanical-equipment room. The requirements for this mechanical-equipment room include refrigerant monitors and alarms, mechanical ventilation, pressure-relief piping, and so forth.

period two

Chilled-Water System Design

notes

Chilled-Water Systems

period two

Chilled-Water System Design

Figure 30

Proper design of a chilled-water system can greatly impact the first cost, operating costs, and flexibility of the HVAC system. The purpose of this period is to discuss the design of reliable chilled-water systems.

Chilled-Water System Components

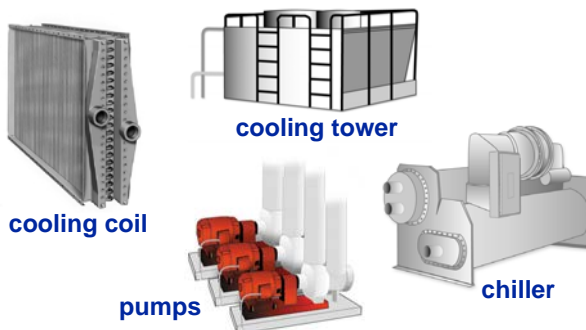

Figure 31

The conventional chilled-water system consists of combinations of the following primary components:

- Water chillers
- Load terminals (chilled-water cooling coils in comfort-cooling applications)
- Cooling towers in water-cooled systems
- Chilled- and condenser-water pumps
- Chilled- and condenser-water distribution systems that include piping, an expansion tank, control valves, check valves, strainers, and so forth.

period two

Chilled-Water System Design

notes

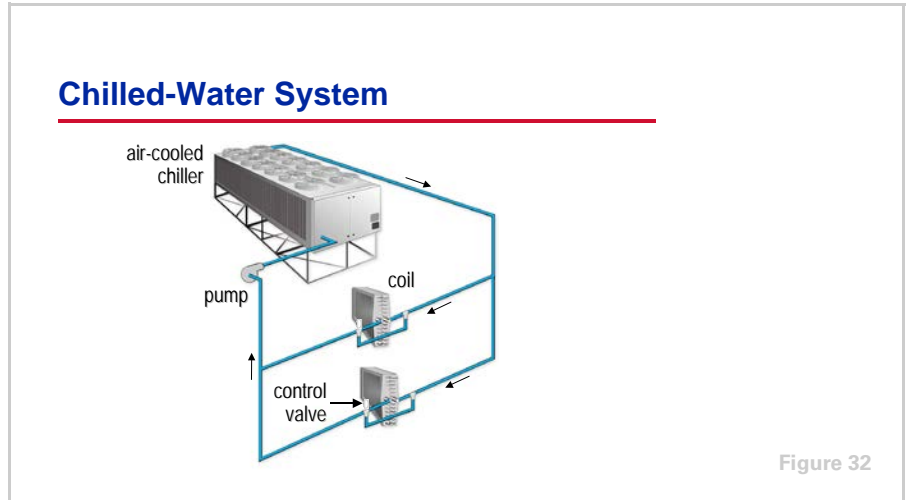

This period focuses on the chilled-water side of the system; that is, the water that flows through the chiller evaporator and out through the load terminals. Specifically, we will review methods of load-terminal control and various multiple-chiller system configurations. These topics apply to systems using both air-cooled and water-cooled chillers.

Fundamentally, the function of the chilled-water system is to transport the cooling fluid from the chillers to the load terminals and back to the chillers. Assuming that the distribution system is adequately sized, we will concentrate on the hydraulic interaction between the load terminals and the chillers.

period two

Chilled-Water System Design

notes

Load-Terminal Control Options

- Three-way modulating valve
- Two-way modulating valve
- Face-and-bypass dampers



Figure 33

Load-Terminal Control

The purpose of load-terminal control is to modulate the flow of air or water through the coil to maintain building space comfort. This is accomplished by measuring the temperature of the supply air or space. The temperature then converted to an electronic signal that modulates the capacity of the cooling coil to match the changing load in the space.

Three methods of load-terminal control are commonly used in chilled-water systems.

- Three-way modulating valve control
- Two-way modulating valve control
- Face-and-bypass damper control

Each of these methods has a different effect on the operation of the system.

period two

Chilled-Water System Design

notes

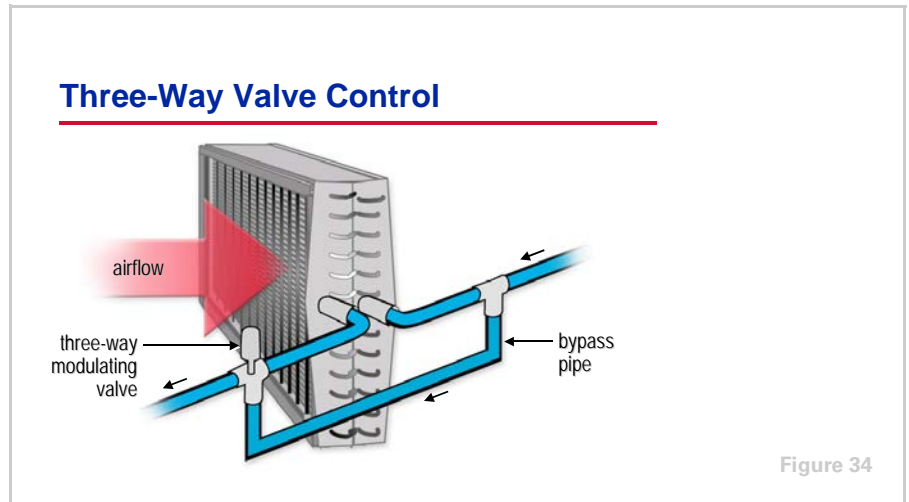

A three-way control valve is one method used to regulate the flow of chilled water through a cooling coil. As the space cooling load decreases, the modulating valve directs less water through the coil, decreasing its capacity. The excess water bypasses the coil and mixes downstream with the water that flows through the coil. As a result, the temperature of the water returning from the system decreases as the space cooling load decreases.

Systems that use three-way valves have the following characteristics:

- The temperature of the water returning from the system varies as the cooling load varies.
- The water flow through each load terminal (water through the coil plus water bypassing the coil) is relatively constant at all load conditions.
- The pump energy is constant at all loads because the use of three-way valves results in constant water flow throughout the system.
- Water-flow balance is very critical to proper operation because the flow is constant.

period two

Chilled-Water System Design

notes

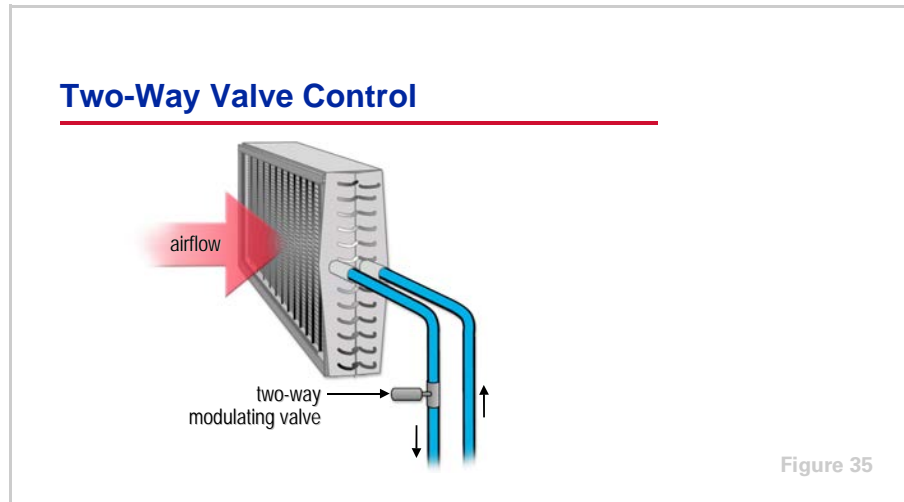

A two-way modulating valve is similar to a three-way valve in that the water flow through the coil is modulated proportionately to the load. The primary difference is that the two-way valve does not bypass any unused water, it simply throttles the amount of water passing through the coil.

The coil and the air being conditioned experience no difference in the cooling effect of using a two-way versus a three-way valve. The chilled-water system, however, sees a great difference. Recall that with a three-way valve, the terminal water flow (water through the coil plus the water bypassing the coil) is constant at all loads. With a two-way valve, the terminal water flow varies proportionately with the load. Because there is no mixing of coil and bypassed water, the temperature of the water leaving the load terminal remains relatively constant at all conditions. In fact, this return-water temperature may actually rise slightly as the load decreases, due to coil heat-transfer characteristics.

Systems that use two-way valves have the following characteristics:

- The temperature of the water returning from the system is constant (or increases) as the cooling load decreases. This increases the effectiveness of options such as heat recovery, free cooling, and base-loading, which will be discussed further in Period Three.
- The water flow through each load terminal varies proportionately to the load, resulting in pump energy savings at part load.
- A variable-flow system is less sensitive to water balance than most constant-flow systems.

A variable-flow, chilled-water distribution system, however, may require another method to provide constant water flow through the chillers, or else the chillers must be equipped to handle variable water flow.

period two
Chilled-Water System Design

notes

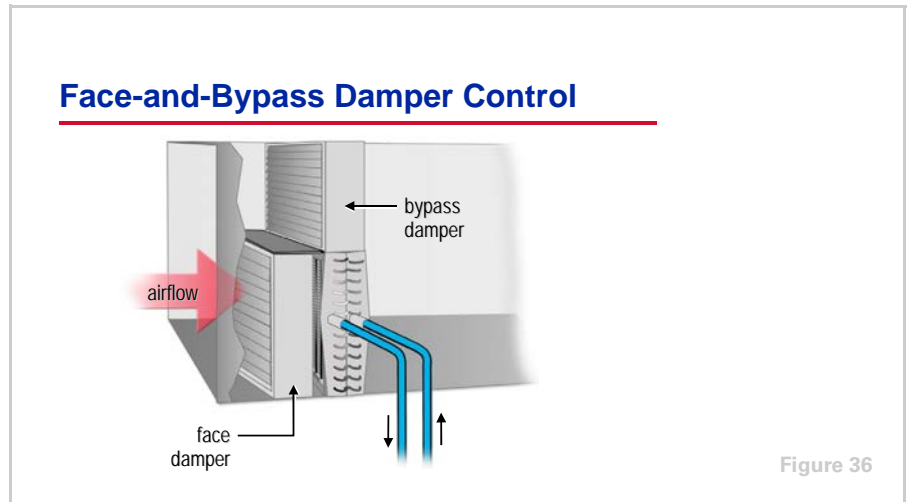

The final method of modulating the coil capacity to match the cooling load is through the use of face-and-bypass dampers. A linked set of dampers varies the amount of air flowing through the coil by diverting the excess air around the coil. As the cooling load decreases, the face damper closes, reducing the airflow through the coil and reducing its capacity. At the same time, the linked bypass damper opens, allowing more air to bypass around the coil. A unique characteristic of this method of load-terminal control is that the coil is allowed to “run wild,” meaning that the water flow through the coil is constant.

Similar to the three-way valve, systems that use face-and-bypass dampers have the following characteristics:

- The temperature of the water returning from the system varies as the cooling load varies.
- The water flow through each load terminal and, therefore, pump energy are constant at all load conditions.

An advantage of face-and-bypass control with a “wild” cooling coil is that it can better dehumidify of the conditioned air when compared to varying the water flow through the coil. As the airflow through the coil decreases at part-load conditions, assuming that the temperature of the water entering the coil is constant, the temperature of the air leaving the coil also decreases. That is, the air is cooled further and more moisture is removed.

period two

Chilled-Water System Design

notes

Load-Terminal Control Options

- **Three-way modulating valve**
 - ◆ Constant water flow
 - ◆ Variable system return-water temperature
- **Two-way modulating valve**
 - ◆ Variable water flow (pump energy savings)
 - ◆ Constant system return-water temperature
- **Face-and-bypass dampers**
 - ◆ Constant water flow
 - ◆ Variable system return-water temperature
 - ◆ Enhanced dehumidification capability with “wild” coils

Figure 37

Properly designed, operated, and maintained, any of these three methods can result in good space comfort control. However, they have different effects on the chilled-water system.

The use of three-way valves or face-and-bypass dampers results in variable return-water temperature and relatively constant chilled-water flow through the entire system. The use of two-way valves results in constant return-water temperature and variable water flow through the entire system. Before choosing one of these control methods, it is necessary to determine the effect that it will have on the other parts of the chilled-water system.

Chiller Evaporator Flow

- **Constant flow is most common**
- **Variable flow is possible**
 - ◆ Can reduce energy consumption
 - ◆ Use only with advanced chiller and system controls

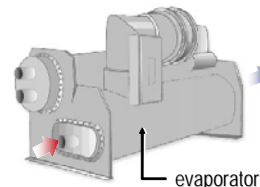

Figure 38

In the past, the water flow rate through the chiller evaporator was to remain as constant as possible. The vast majority of chilled-water systems employ pumping schemes that maintain a constant flow rate of water through each chiller evaporator. Even in the most-carefully-designed chilled-water systems, however, the flow through the chillers will still vary slightly due to system

period two

Chilled-Water System Design

notes

effects. System effects include pump–system curve interaction, dynamic head variations, and variation in distribution system flow.

There are benefits to maintaining a constant water flow rate through the chiller evaporator. Constant flow provides more-stable and-simple chiller and system operation. However, there is potential for energy savings by varying the water flow in the distribution system. Applying these two seemingly-conflicting principles to chilled-water systems requires careful planning and a thorough understanding of hydraulic system operation.

Due to advances in technology, however, many of today’s chillers can operate with variable evaporator water flow. Chilled-water systems that are specifically designed to vary evaporator water flow are discussed in Period Three. This period focuses on systems that employ constant water flow through the chiller and either constant or variable water flow through the rest of the distribution system.

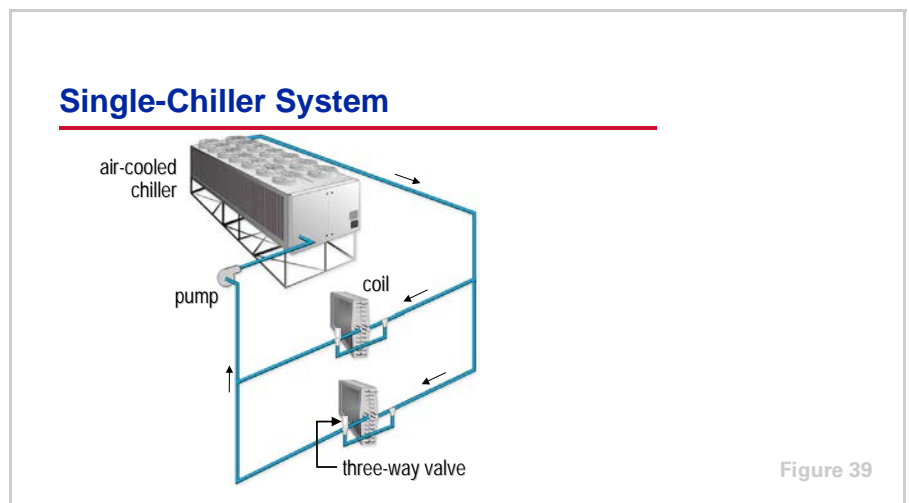

Another factor that influences chilled-water system design is the number of chillers used. Single chillers are sometimes used in small systems (less than 100 tons [35 kW]), while larger or critical systems typically use multiple chillers.

Many single-chiller systems resemble the one shown in Figure 39. This system uses a single pump to move water through the chiller and load terminals. The load terminals are controlled using three-way modulating valves. The pump delivers a constant flow of water throughout the entire system, and flow balance is relatively easy.

period two

Chilled-Water System Design

notes

Multiple-Chiller Systems

- Redundancy
- Part-load efficiency



Figure 40

Multiple-chiller systems are more common than single-chiller systems for the same reason that most commercial airplanes have more than one engine—redundancy provides reliability. Additionally, because cooling loads typically vary widely, multiple-chiller systems can often operate with less than the full number of chillers. During these part-load periods, the system saves the energy required to operate the additional chillers, pumps, and, in water-cooled systems, cooling tower fans.

There are several configurations used to connect multiple chillers in these systems. Some of these configurations work well, others do not. Next, we will look at the most-commonly-used system configurations, including their advantages and drawbacks.

period two

Chilled-Water System Design

notes

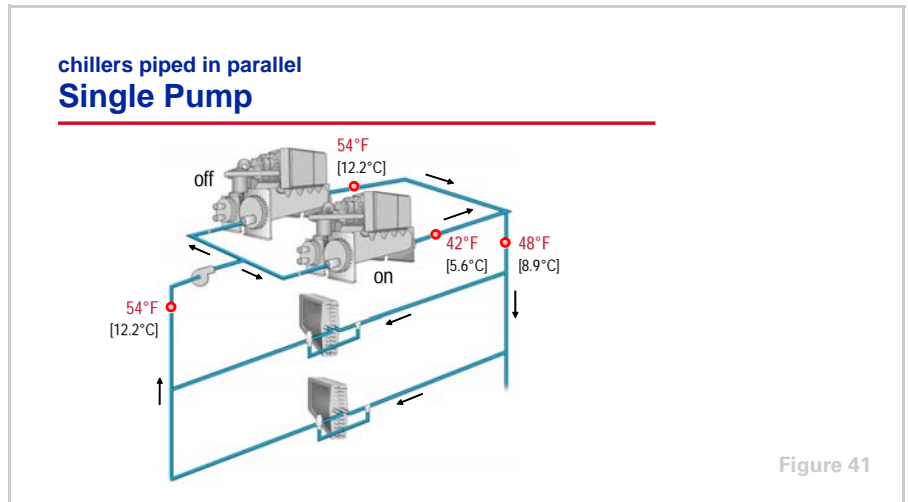

Parallel Configuration

Parallel piping is one common configuration of multiple-chiller systems. Figure 41 shows a system that uses a single pump to deliver chilled water both to chillers and to the system load terminals. This configuration can be used in systems that use constant-flow methods of terminal control (three-way valves or face-and-bypass dampers), or in systems that use variable-flow methods of terminal control (two-way valves). Varying the flow through the load terminals using two-way valves in this type of system results in variable water flow through the chiller evaporators. Chilled-water systems that are specifically designed to vary evaporator water flow will be discussed in Period Three. This section will focus on systems that use constant-flow methods of terminal control.

Water is pumped through both chillers continuously, regardless of whether only one chiller or both chillers are operating. This example system is at 50 percent load, with one chiller operating and the second chiller off. Return water from the system at 54°F [12.2°C] continues to flow through the non-operating chiller and mixes with the chilled 42°F [5.6°C] water produced by the operating chiller. The resulting mixed-water temperature leaving the plant is 48°F [8.9°C]. This rise in supply-water temperature may result in problems with building comfort or humidity control. A chiller-plant controller may be used to reset the set point of the operating chiller downward, in an attempt to compensate for this condition, and more-closely maintain the desired supply-water temperature. Reducing the set point of the operating chiller has its limits, however, depending on the operating characteristics and evaporator freeze limits of the specific chiller. The more chillers in the system, the worse the problem becomes. For this reason, this configuration is seldom used in systems with more than two chillers.

Additionally, ASHRAE/IESNA Standard 90.1–1999 (Section 6.3.4.2) prohibits this type of system when the pump is larger than 10 hp [7.5 kW]. The standard requires that, in systems that contain more than one chiller piped in parallel, system water flow must be reduced when a chiller is not operating.

period two

Chilled-Water System Design

notes

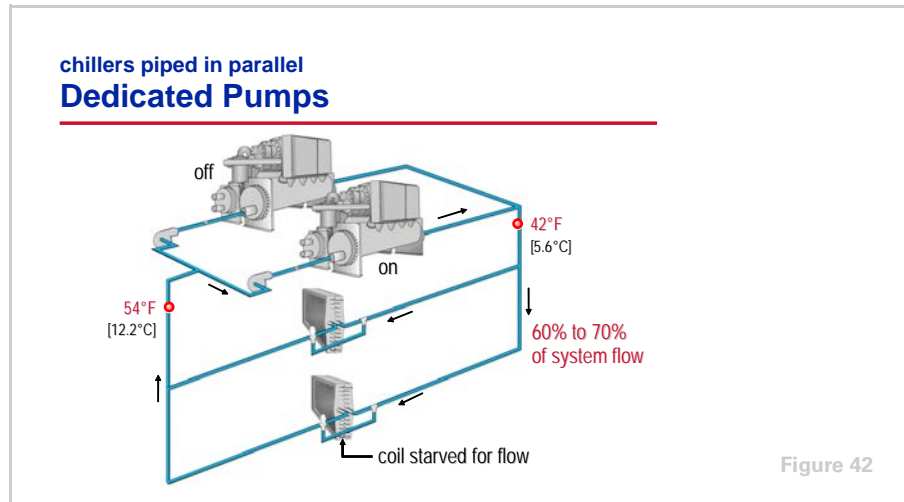

If separate, dedicated pumps are used with each chiller, a pump-and-chiller pair can be turned on and off together as the cooling load varies. This solves the temperature mixing problem that occurred in the previous, single-pump configuration, but it presents a new problem in a system that uses a constant-flow method of terminal control.

Below 50-percent load, only one chiller and one pump are operating. The total water flow in the system decreases significantly, typically 60 to 70 percent of full system flow. Ideally, at this part-load flow rate, all of the coils will receive less water, regardless of their actual need. Typically, however, some coils receive full water flow and others receive little or no water. In either case, heavily-loaded coils will usually be “starved” for flow. Examples of spaces with constant heavy loads that may suffer include computer rooms, conference rooms, photocopy rooms, and rooms with high solar loads.

period two

Chilled-Water System Design

notes

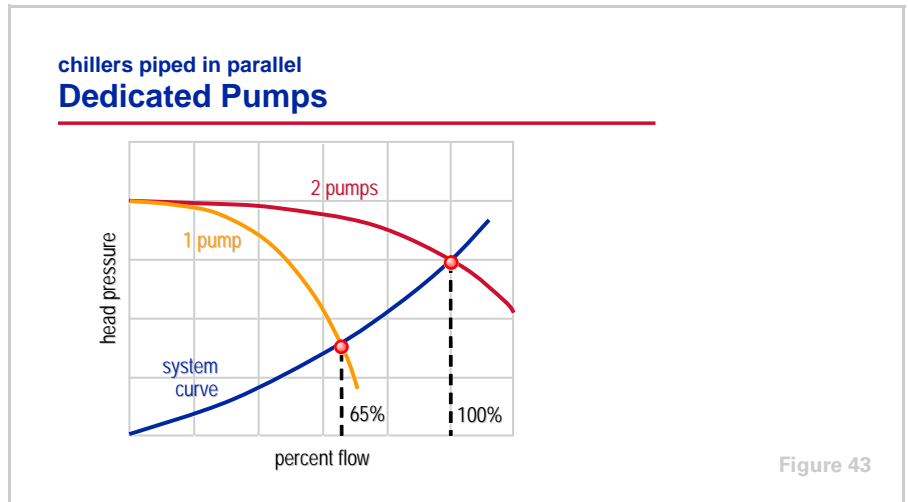

Figure 43 shows an example of the pump–system curve relationship. When both pumps are operating, the system receives 100 percent of design flow. When only one pump is operating, the intersection of the pump’s performance curve with the system curve results in about 65 percent of design flow.

This configuration also presents problems to chiller operation. The starting or stopping of a pump for one chiller affects the flow through the other chiller. Using this same example, if one chiller is operating and a second chiller and pump are started, the total water flow in the system does not double. The system and pump performance curves will “rebalance,” resulting in an increase in system flow of only 35 percent of total flow. The new total flow rate, however, is now divided equally between the two chillers. This results in a rapid reduction in water flow through the original operating chiller, from 65 percent of total system flow to 50 percent. This rapid decrease in flow often results in a loss of temperature control and may cause the chiller to shut off on a safety.

In order to overcome this problem, the chiller-plant control system should anticipate the starting of additional pumps and unload operating chillers prior to the start of an additional chiller. Again, this configuration is sometimes acceptable for two-chiller systems, but is not often used in larger systems because the part-load system flow problems are further multiplied.

period two

Chilled-Water System Design

notes

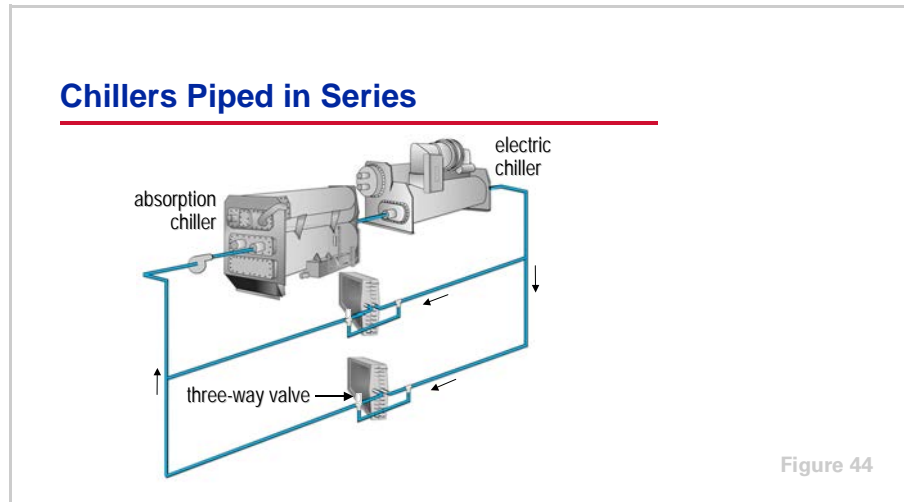

Series Configuration

Another way to connect multiple chillers is to configure the chiller evaporators in series. Series chilled-water systems typically use three-way valves at the coils to ensure constant system flow. With two chillers in series, both the temperature mixing and the flow problems associated with the parallel configurations shown previously disappear. All of the chilled water passes through both chillers, and there is full system-water flow at all loads.

However, the flow rate through each individual chiller is equal to the entire system flow rate. When compared to chillers piped in parallel at the same system ΔT , this is twice as much water flowing through each chiller. This means that the chiller-tube pass arrangement must accommodate double the water quantity within acceptable velocity and pressure drop limits. This typically requires a reduced number of passes in the evaporator and may impact chiller efficiency. This efficiency impact, however, is often offset by the gain in system efficiency due to thermodynamic staging.

System pressure drop also increases because the pressure drops through the chillers are additive. This can result in increased pump size and energy costs. This increase in pumping energy can be substantially reduced by designing the system for a higher system ΔT and, therefore, a reduced water flow rate.

Because of the pressure drop limitations, it is difficult to apply more than two chillers in series. Systems involving three or more chillers typically use either the primary-secondary configuration or parallel sets of two chillers in series.

period two

Chilled-Water System Design

notes

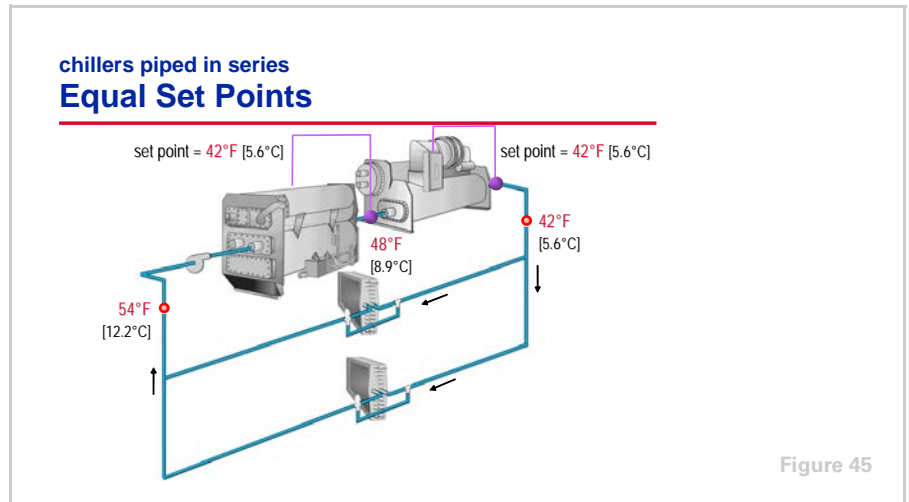

Temperature control in a series system can be accomplished in several ways, depending on the desired operating sequence. The first method, shown in Figure 45, has both set points adjusted to the desired system supply-water temperature. Assuming equally-sized chillers, either chiller can meet the load below 50 percent. Above 50-percent load, both chillers operate and the upstream chiller is preferentially loaded. This means that the upstream chiller is operated at full capacity and any portion of the load that remains is handled by the downstream chiller.

This strategy may be desirable in systems that benefit from preferentially loading the upstream chiller. Examples include:

- Using a heat-recovery chiller in the upstream position. Because the chiller is at full capacity whenever the system load exceeds 50 percent, the amount of heat available for recovery is maximized.
- Using an absorption chiller in the upstream position. An absorption chiller works more efficiently, and has a higher cooling capacity, with higher leaving-chilled-water temperatures. The absorption chiller in the upstream position provides a warmer leaving-chilled-water temperature at design conditions, 48°F [8.9°C] in this example. This arrangement preferentially loads the gas-burning absorption chiller, allowing the system to maximize the use of a lower-cost fuel during periods of high electrical-energy cost.

Alternatively, equal loading of the two chillers in series can be accomplished using a chiller-plant control system to monitor system load and balance chiller loading. The set point for the downstream chiller is set equal to the desired system supply-water temperature, and the set point for the upstream chiller is then dynamically reset to maintain equal loading on both chillers. The control system must be stable enough to prevent control hunting or chiller cycling during periods of changing load.

period two

Chilled-Water System Design

notes

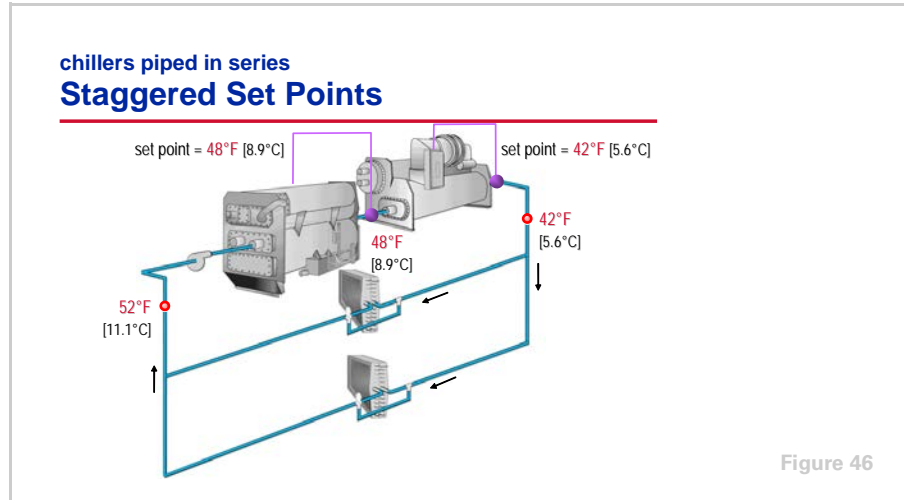

An alternative method of controlling chillers in series involves staggering the set points of the two chillers. This results in the *downstream* chiller operating first and being preferentially loaded. Any portion of the load that the downstream chiller cannot meet is handled by the upstream chiller.

The example in Figure 46 shows the system operating at about 80 percent of design cooling load. As we mentioned earlier, with three-way valves at the coils, the temperature of the water returning to the chillers decreases at part load. At 80-percent load, the return-water temperature is 52°F [11.1°C], instead of the 54°F [12.2°C] at 100-percent load. The upstream chiller is partially loaded, cooling the water to the 48°F [8.9°C] set point, while the downstream chiller remains fully loaded, cooling the water the rest of the way to 42°F [5.6°C].

period two
Chilled-Water System Design

notes

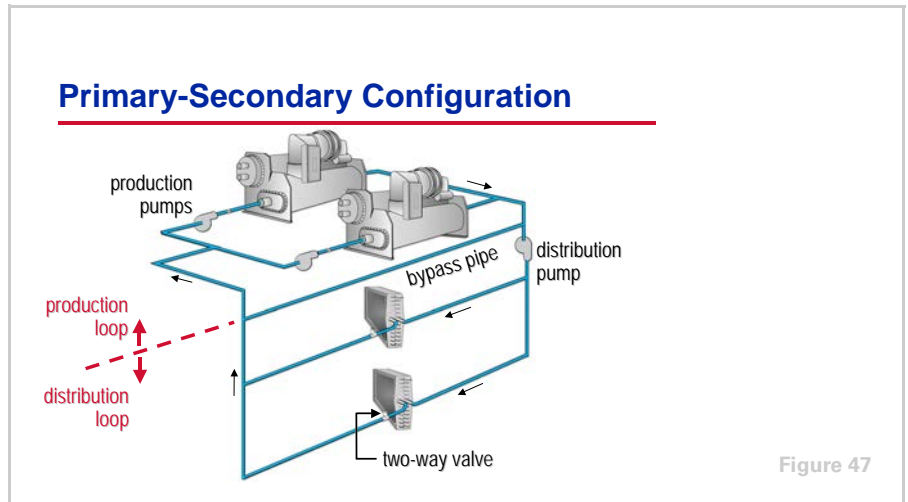

Primary-Secondary (Decoupled) Configuration

If the water flow through the chillers (production) could be hydraulically isolated from the water flow through the coils (distribution), many of the problems encountered in parallel and series configurations could be eliminated.

Figure 47 shows a configuration that separates, or “decouples,” the production capacity from the distribution load. This scheme is known as a **primary-secondary system**, also referred to as a **decoupled system**. This configuration is unique because it dedicates separate pumps to the “production” and “distribution” loops. A bypass pipe that connects the supply and return pipes is the key component in decoupling the system.

The chillers in the production loop receive a constant flow of water, while the coils in the distribution loop, controlled by two-way modulating valves, receive a variable flow of water.

period two

Chilled-Water System Design

notes

Primary-Secondary System Rules

- **The bypass pipe should be free of restrictions**
 - ◆ Sized for minimal pressure drop
 - ◆ Avoid random mixing of supply- and return-water streams
 - ◆ No check valve

Figure 48

The bypass pipe is common to both production and distribution loops. The purpose of the bypass pipe is to hydraulically decouple the production (primary) and distribution (secondary) pumps. Because water can flow freely between the supply and return pipes for both loops, a change in flow in one loop does not affect the flow in the other loop.

The actual extent of hydraulic decoupling depends on the pressure drop due to the bypass pipe. Total decoupling is accomplished only if the bypass pipe is free from restrictions and large enough to produce no pressure loss at all flow rates. Because zero pressure loss is not practical, some insignificant pump coupling will exist. Bypass pipes are typically sized so that the water velocity in the pipe will be 10 to 15 ft/s [3 to 4.5 m/s], based on the water flowing through the bypass pipe at the design flow rate of the largest chiller in the system.

Additionally,

to further minimize pressure drop, the bypass pipe is usually relatively short in length. To prevent random mixing of the supply and return water streams, however, the minimum length of the bypass pipe is typically 5 to 10 pipe diameters.

When designing the bypass pipe, an important issue to keep in mind is that the bypass pipe must be kept free of unnecessary restrictions. For example, a check valve must not be installed in the pipe. Restrictions cause hydraulic coupling that can result in unacceptable chiller flow variations or unstable, and potentially harmful, system pressure variations due to the resulting series-pumping effects. If a manual isolation valve is required for service, it should be large enough to ensure that it does not add significant pressure drop to the bypass pipe.

period two
Chilled-Water System Design

notes

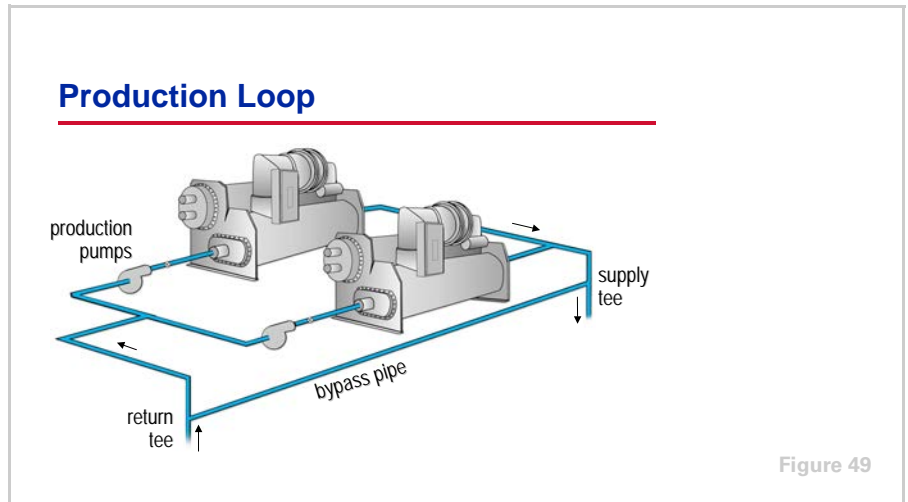

The production pumps circulate water only from the return tee, through a chiller, to the supply tee, and through the bypass pipe. This represents a relatively-small pressure loss and, therefore, relatively-low pump energy. In addition, each pump only operates when its respective chiller is operating.

A primary-secondary system provides a high degree of flexibility in the production loop. Not only are the individual chiller “loops” decoupled from the distribution loop, they are also decoupled from each another. In this configuration, the production loop consists of independent pairs of chillers and pumps. Each pump is turned on and off with its respective chiller. Supply water temperature is maintained by the controls supplied with the chiller. Because the bypass pipe prevents flow interaction between chillers, there is little worry of flow disturbances. In addition, the chillers can be of any type, size, or age, or even from different manufacturers. Because each chiller has a dedicated pump, the chillers can have different evaporator pressure drops.

period two
Chilled-Water System Design

notes

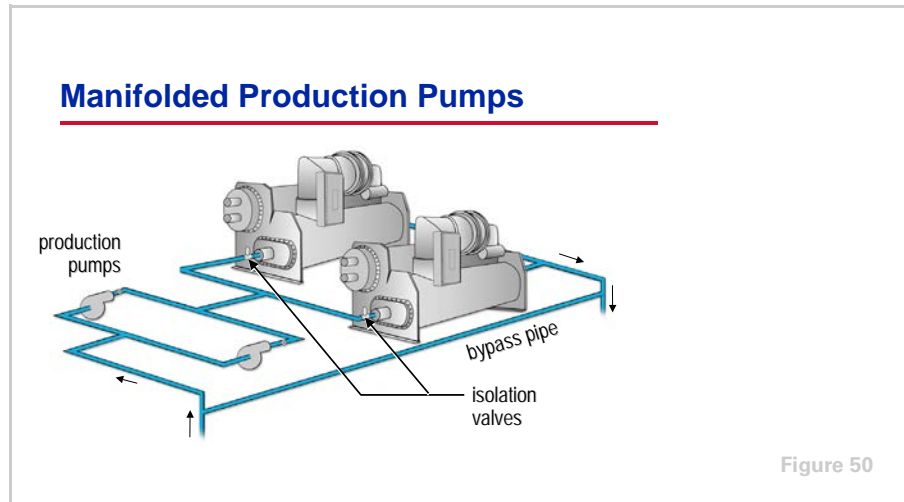

Alternatively, the production loop can be configured with manifolded pumps and automatic, two-position isolation valves at each chiller. When turning on a chiller, a pump is turned on and the isolation valve is opened.

This manifolded-pump configuration provides greater redundancy because the system can change the pump-and-chiller combinations. This redundancy is at the cost of system complexity, and somewhat limits the flexibility of selecting chillers of different capacities and types. If the production pumps are manifolded, the chillers must be selected with the same evaporator-water pressure drop, or else some method of flow balancing must be employed. Pump sizing also becomes an issue if chillers are of different capacities and flow rates, because the proper pump needs to be turned on to match the chiller flow rate.

The drawback of manifolding production pumps is that the chiller flows become hydraulically coupled again. If an isolation valve is opened before a pump is started, flow through the operating chillers will drop suddenly, causing potential control instability. If a pump is started before a valve is open, the operating chillers will see a momentary flow increase, causing control instability or water hammer.

period two

Chilled-Water System Design

notes

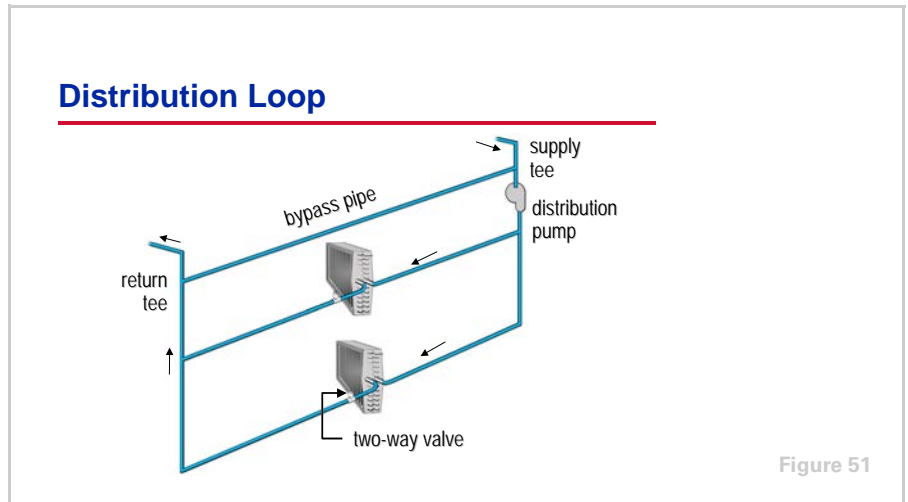

Figure 51

The distribution pump circulates water from the supply tee, through the load terminals, and back to the return tee. Although the same water is pumped twice by different pumps, there is no duplication of pumping energy. The production pumps overcome only the pressure drop through the production loop, and the distribution pumps overcome the pressure drop through the distribution loop.

The distribution pump(s) should be capable of varying the flow through the distribution loop. Typically this is accomplished by using a pump with a variable-speed drive to modulate the flow of water through the pump.

In a properly-designed and -operating system, distribution-pump energy consumption will decrease significantly at part load. The pump power reduction approaches the theoretical cubic relationship to flow. That is, when the load is 50 percent of design, requiring 50 percent of design water flow, the energy consumed by the variable-flow distribution pump is 12.5 percent of full load:

$$(0.50)^3 = 0.125$$

The total installed pump capacity required in a primary-secondary system is typically less than in a system not designed for primary-secondary pumping. This is because the total system head (production plus distribution) is divided between pumps. Each pump is more efficient because it works against a lower head. Furthermore, the distribution pump is sized to meet the diversified (block) system load, not the sum-of-peaks coil loads. This can represent a 20- to 25- percent reduction in the size of the distribution pump.

period two

Chilled-Water System Design

notes

Primary-Secondary System Rules

- The bypass pipe should be free of restrictions
- **Load terminals should use two-way modulating control valves**

Figure 52

Obviously, in order to achieve variable flow at the distribution pump, the load terminals must be configured to vary the system flow. This requires the use of a modulating two-way control valve for each coil. Typically, no three-way valves or wild coils need to be used in a primary-secondary system. Their use decreases the energy savings potential from the variable-flow distribution pump. In fact, ASHRAE/IESNA Standard 90.1–1999 (Section 6.3.4.1) requires the use of modulating two-way control valves, and thus variable water flow, in most systems. Primary-secondary systems comply with this requirement.

Some systems, however, will use one three-way valve at the load terminal furthest from the distribution pump, to ensure that cold water is immediately availability to all terminals in the system.

period two
Chilled-Water System Design

notes

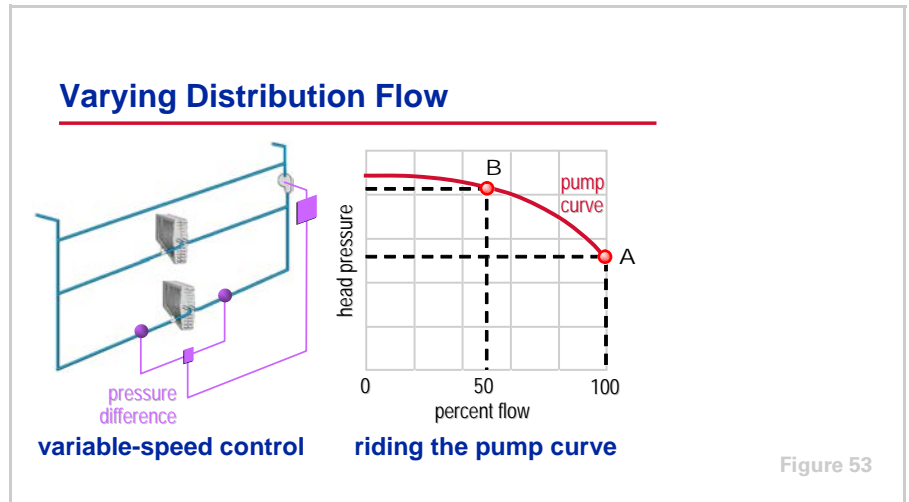

Figure 53

The distribution pump is typically equipped with a variable-speed drive that is controlled to maintain a certain pressure difference between the supply- and return-water piping. In response to a reduced cooling load, the two-way valve modulates closed, restricting the flow of water through the coil. This causes an increase in system differential pressure, which can be measured and used to signal a reduction in the speed of the distribution pump.

An alternative is to allow the pump to “ride its pump curve.” As the two-way valves modulate closed, the increase in system pressure causes the pump to “ride up” its performance curve (**A** to **B**), resulting in a reduction to 50 percent of design flow in this example. This method, however, generally results in less energy savings than a pump with a variable-speed drive. Also, proper pump selection is important and part-load operating conditions must be considered.

In variable-flow systems, ASHRAE/IESNA Standard 90.1–1999 (Section 6.3.4.1) requires the use of a modulation device, such as a variable-speed drive, on pump motors larger than 50 hp [37 kW] that have a pump head greater than 100 ft H₂O [300 kPa].

period two
Chilled-Water System Design

notes

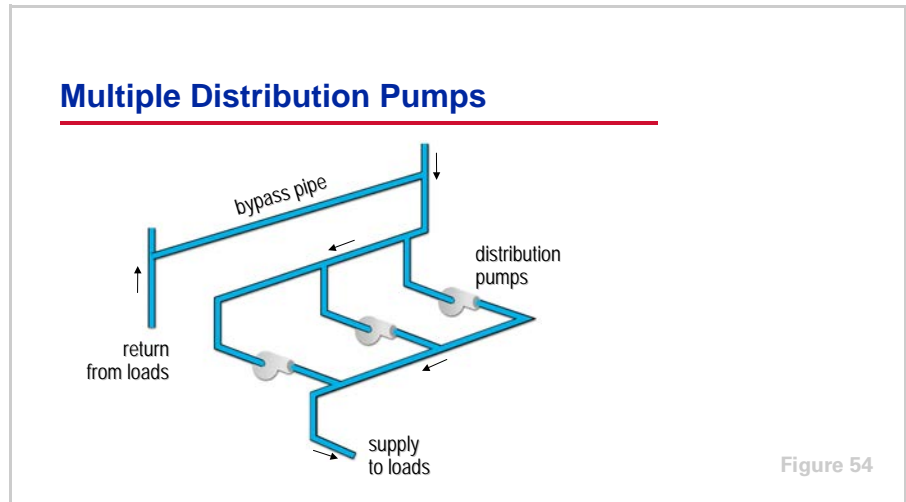

Another advantage of the primary-secondary system is that the production loop is not affected by the distribution pumping arrangement.

For example, multiple distribution pumps can be used to vary the flow within the distribution loop. Providing variable flow through the application of multiple pumps, or through variable-speed drives on one or more pumps, is more energy efficient than simply riding the pump curve. It also provides greater system redundancy.

period two
Chilled-Water System Design

notes

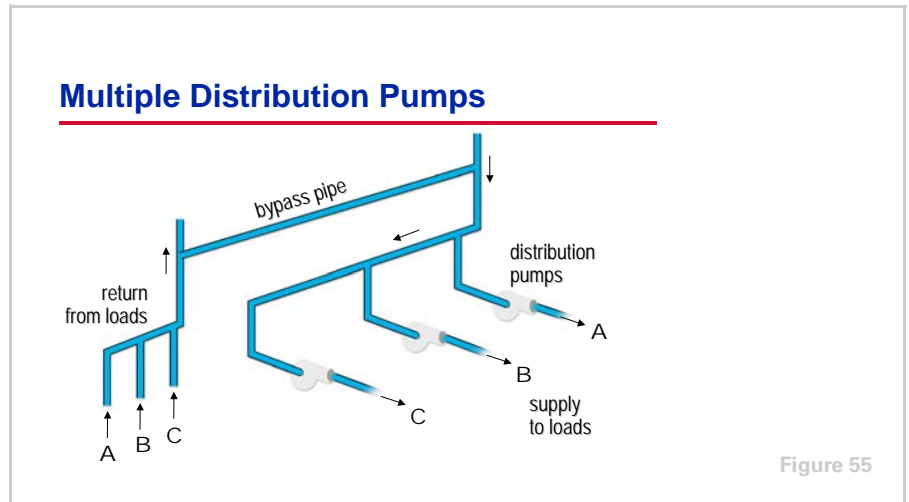

A variation of the multiple-pump configuration is to use separate pumps to deliver water to specific, dedicated loads. An example is a chilled-water system serving a college campus. Separate distribution pumps supply water to the east (**A**), west (**B**), and central (**C**) portions of the campus. A primary advantage of this configuration is flexibility. Expanding the system can be achieved by simply adding another distribution pump to the existing plant and connecting it to the piping that runs to the new building.

A variation of this multiple, dedicated pump configuration is often called distributed pumping. It is sometimes used in very large systems that serve multiple buildings. In a distributed pumping system, a dedicated distribution pump is located out in the system at each building, instead of all the pumps being housed in the chiller plant. This configuration offers the potential for additional pump energy savings, because each pump only needs to pump the water required for the building it serves.

period two
Chilled-Water System Design

notes

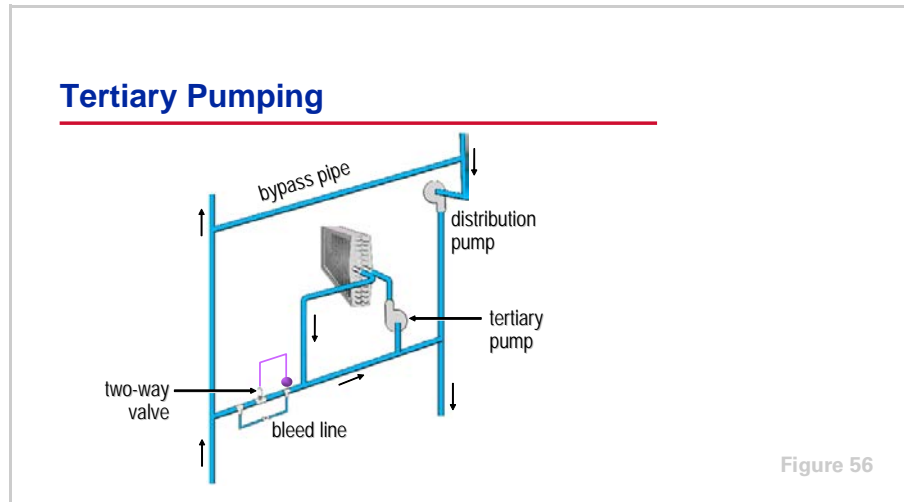

In very large systems, a primary-secondary-tertiary pumping configuration is sometimes used. The primary pumps circulate water through the chillers. The secondary distribution pumps circulate the water around the distribution loop. The individual load terminals are decoupled from the distribution loop and each load terminal has a dedicated tertiary pump.

A “load terminal” in this case may be an individual cooling coil or an entire building. In systems that use tertiary pumping, the load terminal must be controlled so that only the quantity of water required is drawn from the distribution loop. Water must not be allowed to flow into the return piping until it has experienced the proper temperature rise. The two-way valve modulates to maintain the design return-water temperature. A constant-volume tertiary pump circulates water through the load terminal.

Some tertiary pumping systems use a small bleed line to ensure that water will be immediately available when the tertiary pump is started, and to provide an accurate control signal when the two-way valve is closed. It also keeps the distribution pump from “dead-heading,” or trying to pump when all of the two-way valves are closed. If a bleed line is used, it should be of a much smaller diameter than the rest of the piping.

period two

Chilled-Water System Design

notes

Distribution Loop Characteristics

- Reduced pump energy use
- Distribution loop sized for system diversity
- Higher return-water temperatures

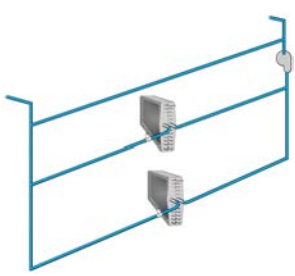

Figure 57

Let's summarize: When designed and operated correctly, the distribution loop of the primary-secondary system has the following characteristics:

- **Variable water flow.** Only the amount of water that is actually used at the load terminals is pumped throughout the distribution loop. Under most operating conditions, this flow rate is less than the design flow rate, resulting in reduced pumping energy.
- **Load diversity.** Not all of the load terminals peak at the same time. Therefore, the quantity of water that flows at any given time is less than the constant water flow required in a system using three-way valves. This allows for reduced distribution pump and pipe sizes.
- **Higher return-water temperature at all loads.** Properly-operating two-way valves do not allow unused chilled water to bypass the load terminals. Water is only allowed to enter the return pipe after it has accomplished some useful cooling. If the system is operating properly, the temperature of the water returning from the load terminals will be at least as high as it is at design load conditions, and may actually rise at part-load conditions. This warm return water is especially advantageous in systems using heat recovery, free cooling, or preferential loading of chillers. These options will be discussed in Period Three.

period two

Chilled-Water System Design

notes

Primary-Secondary System Rules

- The bypass pipe should be free of restrictions
- Load terminals should use two-way modulating control valves
- **All chillers should be selected for the same leaving chilled-water temperature and ΔT**

Figure 58

For simplicity of system control, all of the chillers in a primary-secondary system should be selected to operate with the same leaving-water temperature and with the same temperature difference (ΔT). This allows all operating chillers to be loaded to equal percentages.

Control of supply-water temperature is fairly simple. The set points of the individual chillers are all equal to the desired system supply-water temperature. Because water flows only through operating chillers, there is no water mixing in the production loop, and the production loop supplies the water temperature corresponding to the individual chiller set points.

period two

Chilled-Water System Design

notes

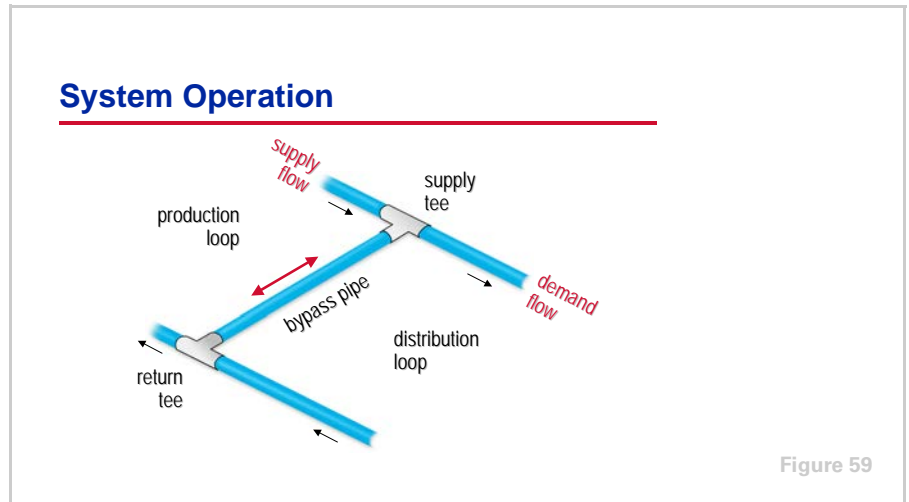

Primary-Secondary System Operation

We have seen that the production and distribution loops of the primary-secondary system act independently. The next consideration is to match the capacity of the production loop to the load of the distribution loop. The operation of a primary-secondary system focuses on the direction and amount of flow in the bypass line.

At the supply tee, which connects the supply and bypass pipes, a supply-and-demand relationship exists. The total water flow from all operating production (chiller) pumps is the "supply" flow. The "demand" flow is the total water flow required to meet the loads on the cooling coils. Whenever the supply and demand flows are unequal, water will either flow into, or out of, the bypass pipe at the supply tee.

period two

Chilled-Water System Design

notes

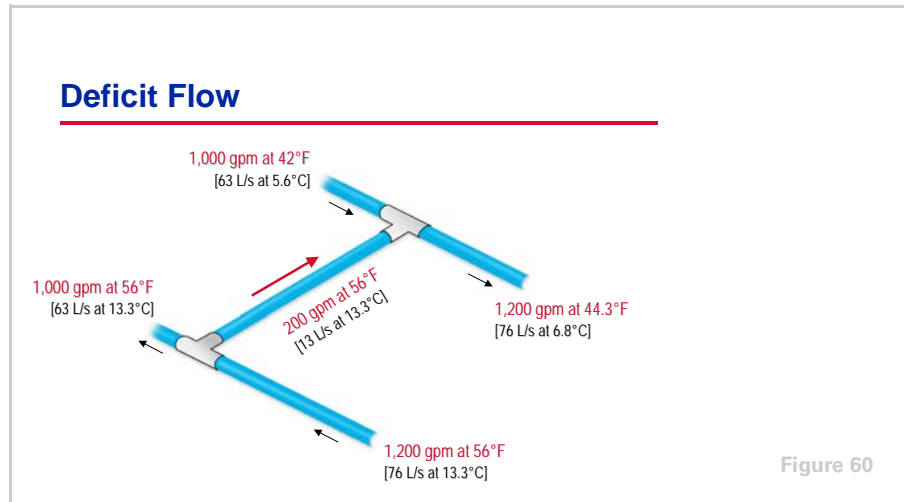

If production supply is inadequate to meet the load demand, a “deficit” of supply water exists. To make up for this deficit, the distribution pump will pull water from the return pipe of the distribution loop through the bypass pipe. This is called **deficit flow**.

In this example, the pumps operating in the production loop are supplying 1,000 gpm [63 L/s] of water while the distribution pump is pumping 1,200 gpm [76 L/s] to meet the demand of the cooling coils. The result is that 200 gpm [13 L/s] of system return water flows through the bypass pipe to be mixed with the supply water from the production loop. The temperature of the mixed water supplied to the distribution loop is 44.3°F [6.8°C].

Control of the water temperature supplied by the distribution loop is compromised due to this mixing. When this deficit flow condition exists, starting an additional chiller and pump increases the supply water flow from the production loop. It also changes the supply-and-demand relationship in order to restore the temperature of the chilled water supplied to the distribution loop.

period two

Chilled-Water System Design

notes

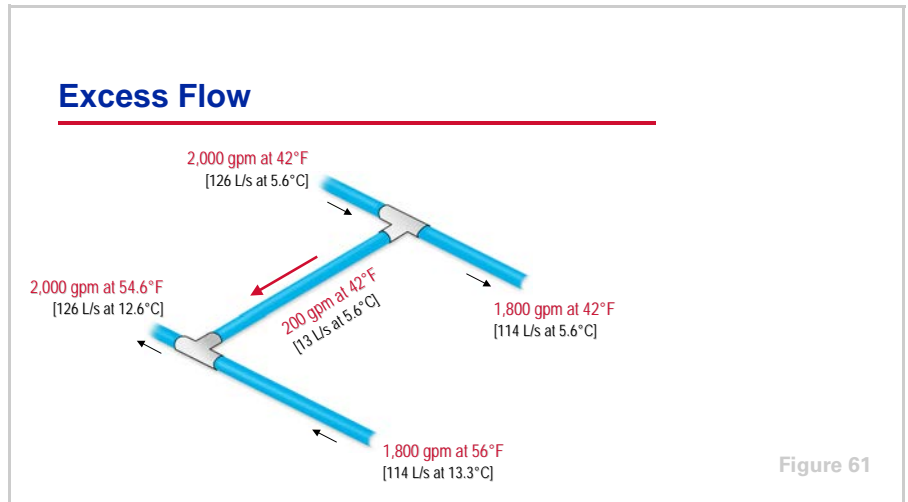

When the flow of chilled water from the production loop exceeds the demand of the distribution loop, the direction of flow in the bypass pipe reverses. Chilled water flows from the supply side of the production loop, through the bypass pipe, and mixes with warm water returning from the distribution loop. This is called **excess flow**.

In this example, the pumps operating in the production loop are supplying 2,000 gpm [126 L/s] of water, while the distribution pump is pumping 1,800 gpm [114 L/s] to meet the demand of the cooling coils. The result is that 200 gpm [13 L/s] of supply water flows through the bypass pipe to be mixed with the water returning from the production loop. The temperature of the water returning to the chillers decreases to 54.6°F [12.6°C], reducing the load on the operating chillers.

Some excess flow is normal in the operation of a primary-secondary system. The amount of excess flow is almost always less than the flow of one production pump. The energy consumed by pumping this excess water through the production loop is typically very low, because the production pump only needs to produce enough head to push the water through the chiller evaporator and the bypass pipe.

If a pump-and-chiller pair is turned off as soon as this excess flow condition occurs, deficit flow will result and the pump and chiller will be turned on again. To prevent this from happening, a production pump and its respective chiller are not turned off until the excess bypass flow exceeds the capacity of the next production pump that is to be turned off.

Some systems are designed with variable flow also in the production loop. Although this minimizes excess flow in the bypass pipe and further reduces production-energy consumption, it results in a significantly-more-complex control system. This type of system will be discussed in Period Three.

period two

Chilled-Water System Design

notes

Control of Primary-Secondary System

condition	response
deficit flow for specified period of time	start another chiller and pump
excess flow greater than 110% to 115% of next pump to turn off	turn off next chiller and pump
neither	do nothing

Figure 62

Starting and stopping of pump-and-chiller pairs in a primary-secondary system depends on the direction and quantity of water flow in the bypass pipe.

- Whenever there is deficit flow through the bypass pipe for a specified period of time (typically 15 to 30 minutes in a comfort-cooling system), another pump-and-chiller pair started.
- Whenever there is excess flow through the bypass pipe that is greater than the flow being produced by the next pump-and-chiller pair to be turned off, that pump and chiller are turned off. To prevent short cycling as the result of a slight increase in load, the chiller-plant control system will typically allow excess flow of from 110 to 115 percent of the flow produced by the next production pump to be turned off.
- If neither of the above conditions exist, no action is taken.

period two

Chilled-Water System Design

notes

Types of Fluid Flow Meters

- **Pressure-based**
 - ◆ Pitot tube
 - ◆ Venturi
 - ◆ Orifice plate
 - ◆ Differential pressure
- **Turbine and impeller**
- **Vortex**
- **Magnetic**
- **Ultrasonic**

Figure 63

The direction and quantity of flow in the bypass pipe may be determined either directly by using a flow meter or indirectly by sensing temperatures.

Direct flow measurement can be accomplished using a variety of flow-meter technologies. These include pressure-based flow meters (pitot tubes, venturi meters, orifice plates, and differential pressure sensors), turbine and impeller meters, vortex meters, magnetic flow meters, and ultrasonic transit-time meters. The accuracy, ease of installation, required maintenance, and cost of these meter technologies vary widely. The accuracy and reliability of the flow meter will directly impact the efficiency and reliability of the chilled-water system. High-quality flow meters are critical to proper system operation.

When using a flow meter, it is important to understand the range of flows and velocities that the specific device can accurately measure. The accuracy of some flow meters is dependent on the velocity of the flow and the development of a smooth flow profile in the stream being measured. To obtain accurate measurements, several diameters of straight pipe may be required, both upstream and downstream of the meter. Finally, in order to give accurate results, many types of flow meters require periodic calibration. This is often overlooked in the maintenance of chilled-water systems.

period two
Chilled-Water System Design

notes

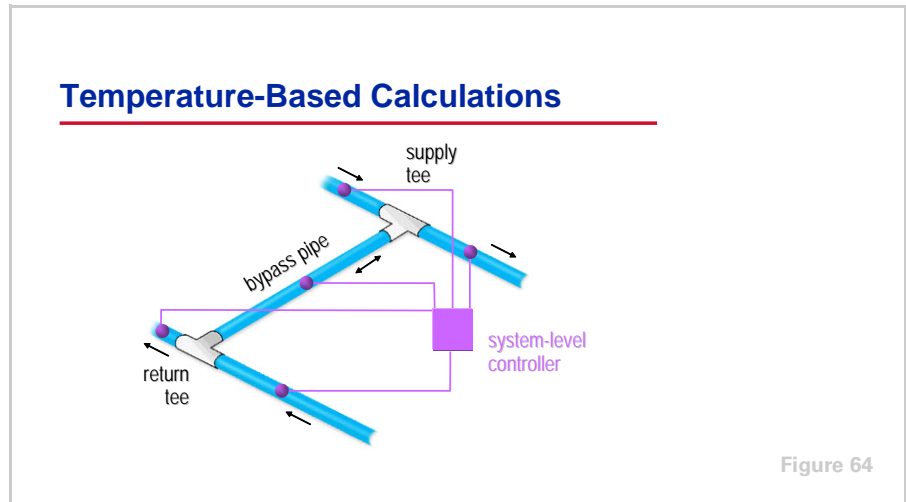

The advent of microprocessor-based controls has led to another method for determining flow in the bypass pipe. Temperature sensors are placed in the supply and return pipes of the production and distribution loops, and in the bypass pipe. With these temperatures, a chiller-plant control system, programmed with fluid mixing equations, can determine the quantity of excess or deficit flow that exists at any time. Because a small change in temperature may indicate a relatively large change in load or flow in the bypass pipe, it is important to use accurate, calibrated sensors to ensure acceptable system operation.

The primary advantage of this method is that it does not depend on flow velocity in the pipe. Also, it is reliable and cost effective because the temperature sensors are relatively-low-cost devices.

Integrating the chiller controls with a chiller-plant control system, however, is imperative for efficient system operation. The control of chilled-water systems will be discussed further in Period Four.

period three

System Variations

notes

Chilled-Water Systems

period three
System Variations

Figure 65

Period Two discussed several standard configurations of chilled-water systems. In addition, there are many variations available to reduce installed costs, enhance the efficiency of the system, improve reliability, or increase operational flexibility.

These variations are worth examining, because improving the reliability or efficiency of the system by even a small percentage can result in a large payback over the life of a building.

Electric Utility Deregulation

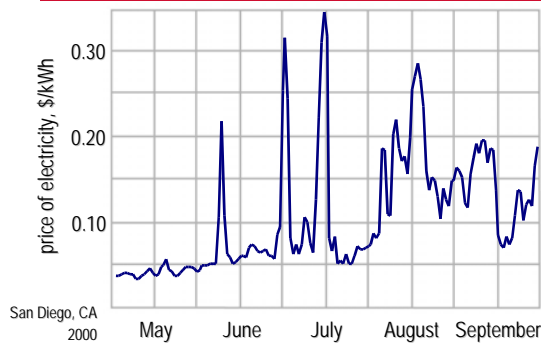

Figure 66

Alternate Fuel Choice

Many building owners and operators are investigating the use of fuels other than electricity. There are several reasons for this renewed interest.

Today, the utility industry in many regions is going through some degree of deregulation. One of the first United States locations to experience this was San Diego, California. Due to a number of factors, the price of electricity

period three

System Variations

notes

doubled, and even tripled, during periods of high demand in the first summer of deregulation. Utility deregulation will occur differently in various locations, but the possibility of high electricity costs during peak periods has building owners and operators looking for ways to use different fuels during those periods.

Another reason for using different fuel types is that it provides the building owner with leverage to negotiate for reduced utility prices from competing utilities. If a building uses both electricity and natural gas for cooling, and can switch between the two, the owner can often negotiate better rates for both cooling and heating.

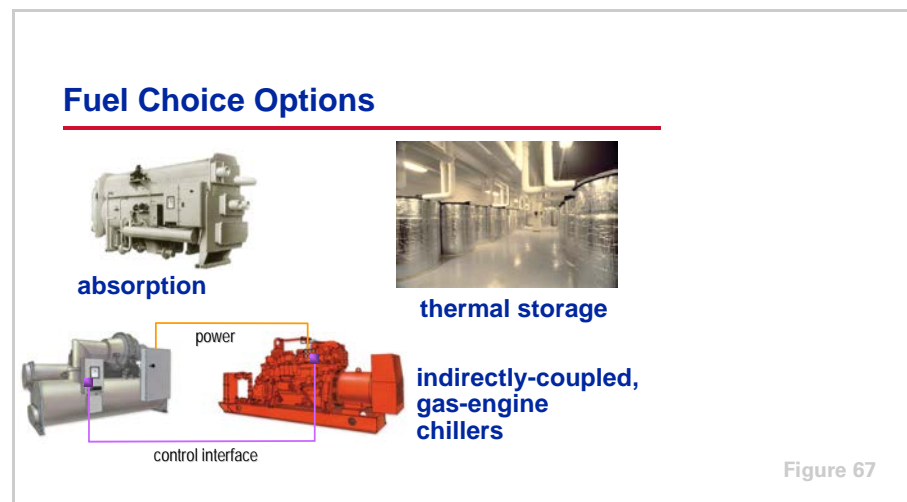

A chilled-water system that uses more than one type of fuel is referred to as a **hybrid system**. The most obvious option for using an alternate fuel is an absorption chiller. This type of chiller can be powered by natural gas, fuel oil, or even waste heat in the form of steam or hot water.

Another option is to use natural gas to operate an engine-and-generator set that produces electricity, and then use that electricity to run a standard electric chiller. This indirect coupling of the gas engine to the chiller allows the flexibility of operating the chiller using the gas engine during times of high electricity costs, and operating the chiller on utility (line) electricity during times of low electricity costs. A second benefit of indirect coupling is that the engine can be sized to provide enough power for the chiller, the pumps, and, in a water-cooled system, the cooling tower. If the engine is also to be used for emergency backup, the pumps and cooling tower would not need a second generator to provide them with power.

An alternative to this approach is to directly couple the engine and chiller. A significant drawback of this approach is that the building owner does not have the flexibility to switch between natural gas and electricity—the chiller must always operate on natural gas. Also, only the chiller is connected to the engine. If emergency backup is necessary, a second generator is required to operate the pumps and cooling tower.

period three

System Variations

notes

A third method of using an “alternate” fuel is actually to use the same fuel (electricity) but to use it at a different time. The highest electricity costs occur at the time of highest demand. For example, a real-time-pricing rate for electricity may be \$0.50/kWh at times of peak demand during the day but only \$0.03/kWh at night. By using either ice or chilled water to store cooling capacity at night when the cost of electricity is low, and then using that stored energy to help cool the building during the day when the cost of electricity is high, total electric costs can be reduced substantially. Although thermal storage does not use a different fuel, it is certainly an option for avoiding high electricity costs during peak periods.

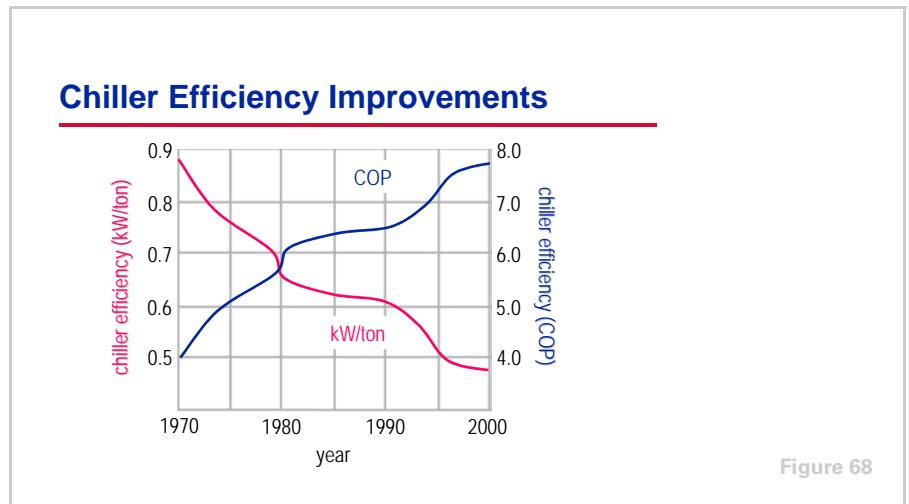

Low-Flow Systems

Building owners are becoming more conscious about how improved efficiency reduces system operating costs and overall environmental impact. Typically, the largest piece of equipment in the chilled-water system is the water chiller. However, it is also the most efficient piece of equipment in the system.

Figure 68 shows the dramatic improvements in chiller efficiency, at standard ARI conditions, since 1970. High-efficiency compressors and motors, economizers on multiple-stage centrifugal compressors, more heat-transfer tubes, and tubes with special geometry to enhance heat transfer in both the evaporator and condenser, have all contributed to these efficiency improvements. Manufacturers continue to strive to improve chiller efficiency by redesigning chiller components.

period three

System Variations

notes

Greater Focus on System Efficiency



Figure 69

Realize, however, that the chiller is only one component of the chilled-water system. Although chiller efficiency is important, overall system efficiency is more important because the building owner pays to operate the entire system, not just the chiller. Said another way, “The meter is on the building!”

With this in mind, many system design engineers are looking for ways to optimize the efficiency of the entire system, not just the chiller.

Trend Toward Lower Flow Rates

electric-driven chiller	yesterday	today
evaporator flow rate	2.4 gpm/ton [0.043 L/s/kW]	1.5 gpm/ton [0.027 L/s/kW]
leaving chilled-water temperature	44°F [6.7°C]	41°F [5°C]
condenser flow rate	3.0 gpm/ton [0.054 L/s/kW]	2.0 gpm/ton [0.036 L/s/kW]
entering condenser-water temperature	85°F [29.4°C]	85°F [29.4°C]

Figure 70

One approach to increase overall system efficiency has been to reduce pump and cooling-tower energy by reducing the amount of water being pumped through the system. In the past, the conditions shown in the center column of the table in Figure 70 were often used when designing a water-cooled, chilled-water system. These flow rates result in a 10°F [5.6°C] temperature difference (ΔT) through both the evaporator and the condenser. In fact, they are the standard conditions at which electric, vapor-compression chillers are rated by

period three

System Variations

notes

ARI. They are not, however, suggestions for good design practice for any given system—they simply define a common rating point to aid comparisons.

Trends toward improved humidity control and system-level energy efficiency have led many design engineers to reduce the flow rates on both the chilled- and condenser-water sides of the system. This results in smaller motors in the pumps and cooling-tower fans, as well as smaller pipes and control valves in the distribution system. The right column of this table shows one possible set of conditions for a **low-flow system**. For comparison, 1.5 gpm/ton [0.027 L/s/kW] through the evaporator results in a 16°F [8.9°C] ΔT , and 2.0 gpm/ton [0.036 L/s/kW] through the condenser results in a 15°F [8.3°C] ΔT .

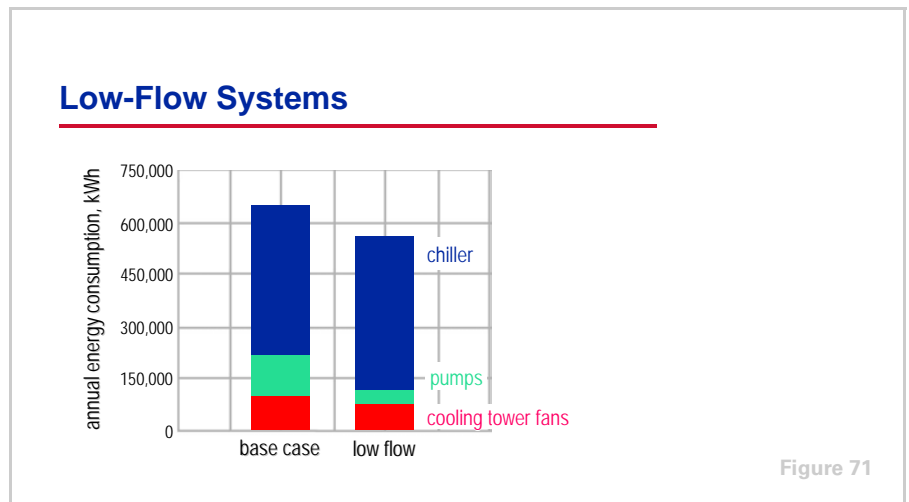

Figure 71

Figure 71 shows the combined annual energy consumption of the chiller, chilled- and condenser-water pumps, and cooling-tower fans for these two system designs. In fact, a growing number of design engineers and utilities have published papers or manuals that recommend that system flow rates be reduced. A number of them have found that using lower flow rates can reduce both installed and operating costs.

“...there are times you can ‘have your cake and eat it too.’ In most cases, larger ΔT 's and the associated lower flow rates will not only save installation cost but will usually save energy over the course of the year. This is especially true if a portion of the first-cost savings is reinvested in more efficient chillers. With the same cost chillers, at worst, the annual operating cost with the lower flows will be about equal to ‘standard’ flows but still at a lower first cost.”

(Source: Kelly, David W. and Chan, Tumin, “Optimizing Chilled Water Plants,” *Heating/Piping/Air Conditioning*, January 1999)

period three

System Variations

notes

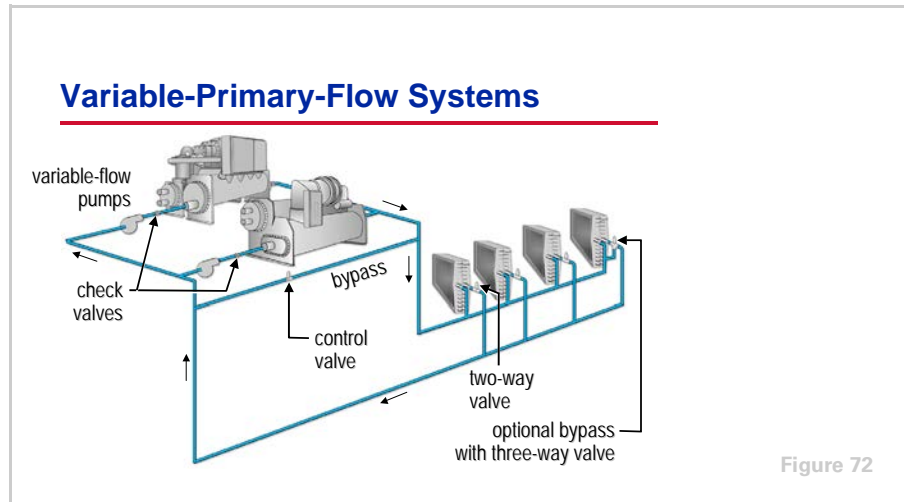

Variable-Primary-Flow Systems

One of the reasons that many chilled-water systems are installed using the primary-secondary configuration is that, in the past, chillers could not respond well to varying water flow through the evaporator. Therefore, the production loop was designed for a constant flow through the chillers, and the distribution loop was designed for variable flow to take advantage of the pump energy savings. The system was hydraulically decoupled to meet these two goals.

Alternatively, in a **variable-primary-flow (VPF) system**, the flow of water varies throughout the entire system—through the evaporator of each operating chiller as well as through the cooling coils. The VPF system differs from the primary-secondary system in that it no longer hydraulically decouples the two loops. The variable-flow pumps move the water through the entire system. The primary benefit of this system is the elimination of the separate distribution pump(s) and the associated electrical and piping connections. There is also a small reduction in operating cost because there is seldom excess water flowing through the bypass pipe.

VPF systems, however, require chillers that can operate properly when the water flow through the evaporator varies. Many of today's chillers can tolerate variable water flow through the evaporator, within limits. These limits include minimum and maximum flow rates and a limitation on how quickly the flow can vary. Exceeding these operating limits may cause control instability or even catastrophic failure. The VPF system therefore requires a method of monitoring the flow rate through each chiller and a control system to ensure that the flow through the evaporator stays within the limits for the specific chiller. Do not attempt to use a VPF system with chillers that have older, analog electric, or pneumatic controls that cannot handle variable evaporator flow.

period three

System Variations

notes

Notice also that the VPF system must continue to include a bypass. Although a control valve prevents flow in the bypass for most system operating conditions, the modulating valve and bypass are required to ensure that the water flow through the system remains above the minimum flow limit of the operating chillers. This bypass may be in the same location as in the primary-secondary system, or it may be a three-way valve on a few of the cooling coils.

Critical VPF System Requirements

- **Chillers must handle variable evaporator flow**
- **System must include a bypass**
- **System-level controls must limit the rate-of-flow change**
- **Adequate time to design and commission controls**
- **Operator must understand the system**

Figure 73

Although VPF systems have been successfully installed and operated, they are more complex both to design and to operate when compared to a primary-secondary system. The sequencing of chillers and pumps requires a thorough understanding of system dynamics because flow rates will vary through every operating chiller. The control system needs to avoid cycling (restarting the chiller too soon) and maintain the rate-of-flow variation through the chiller evaporators within the allowable limits. This becomes very complicated as the number of chillers increases.

Another important consideration when investigating VPF systems is the fact that they take more time and planning to design and commission properly than other systems. The system design engineer must thoroughly define the control sequence early in the design process, and clearly communicate it to the controls provider. Also, the system operators must understand how the VPF system works; therefore, training is mandatory. The success of a system design is directly related to the ability of the operator to carry out the design intent.

period three

System Variations

notes

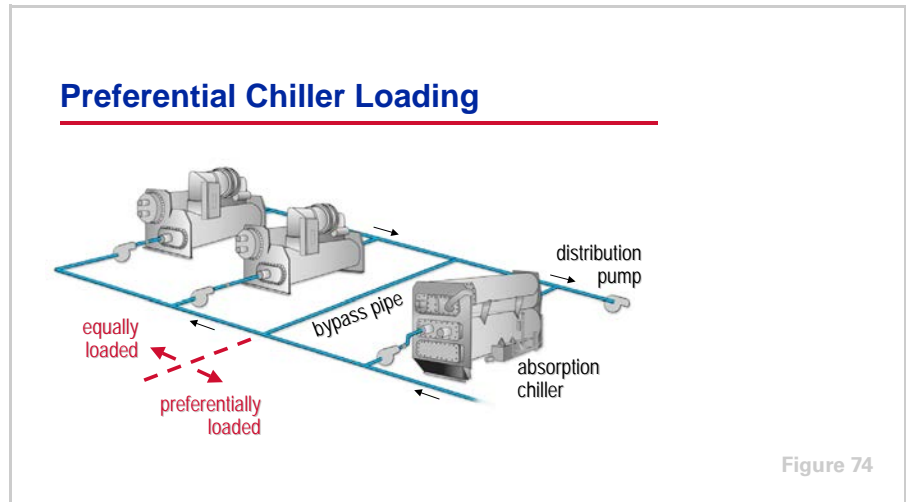

Preferential Loading

To take full advantage of a high-efficiency, heat-recovery or alternate-fuel chiller, the system may need a method to preferentially load these chillers. The following two system configurations are variations of the primary-secondary system.

In the basic primary-secondary system, all operating chillers are loaded to equal percentages. In this first preferential-loading configuration, the preferentially-loaded chiller is moved to the distribution side of the bypass pipe. This chiller is preferentially (or most fully) loaded when it is turned on, because it always receives the warmest system return water. In this example, an absorption chiller is located on the distribution side of the bypass pipe so that it can be preferentially loaded during periods of high electricity costs.

period three

System Variations

notes

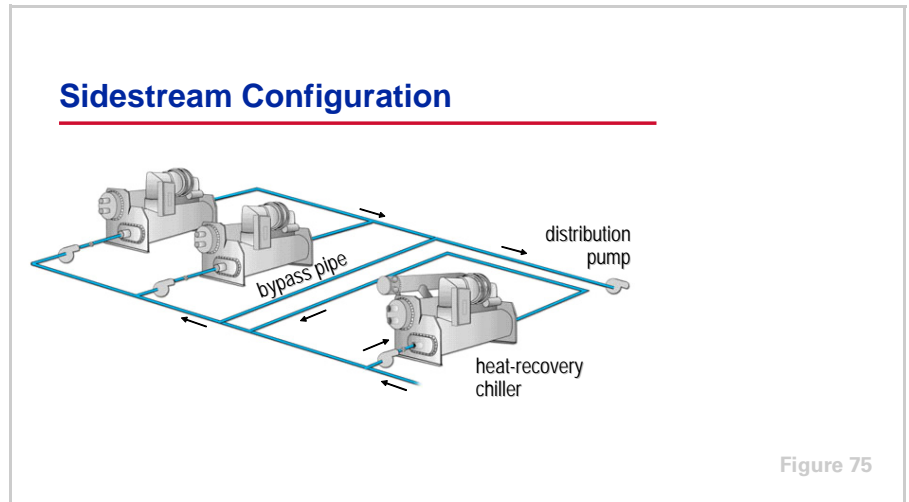

The second preferential-loading configuration, shown in Figure 75, ensures that the chiller in the **sidestream** position receives the warmest entering-water temperature, and that it can be fully loaded whenever the system load is high enough. This arrangement is unique because it not only allows preferential loading, but it also permits the chiller (or other cooling device) in the sidestream position to operate at any temperature difference. In other words, it does not need to supply water at the same temperature that the other operating chillers do. The chiller in this position pre-cools the system return water, reducing the load on the downstream chillers. In this example, a heat-recovery chiller is located in the sidestream position so that it can be preferentially loaded to maximize the amount of heat recovered, thus reducing the overall building energy consumption. Because a heat-recovery chiller is typically less efficient than a standard cooling-only chiller, the heat-recovery chiller only has to provide as much cooling as is required to meet the heat-recovery load, letting the more efficient cooling-only chillers meet the rest of the cooling load.

One drawback of the sidestream arrangement is that it does not add water flow capability to the system, it simply reduces the load on other chillers. Therefore, the other system pumps must ensure that the system flow requirements are met. For this reason, the capacity of the sidestream chiller is often smaller than the other chillers in the plant.

Either of these arrangements allows a chiller to be preferentially loaded. Preferential loading is typically most beneficial in the following applications:

- In a system that has a high-efficiency chiller along with several standard-efficiency chillers, the high-efficiency chiller can be preferentially loaded to reduce system energy consumption.
- In a system with a heat-recovery chiller, preferentially loading the heat-recovery chiller maximizes the amount of heat recovered, thus reducing the overall building energy consumption.

period three

System Variations

notes

- In a system with an alternative-fuel chiller, such as an absorption chiller, preferentially loading the alternative-fuel chiller during times of high electricity costs minimizes system energy cost.

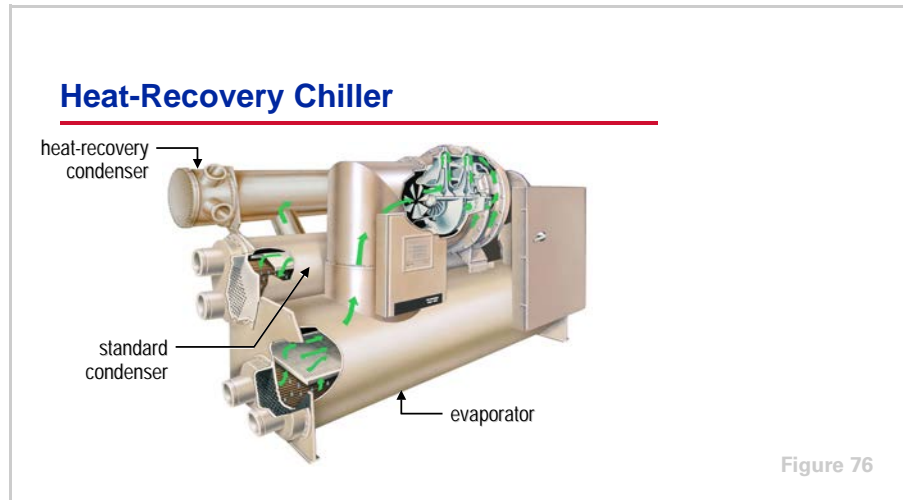

Heat Recovery

Heat recovery is the process of capturing the heat that is normally rejected from the chiller condenser and using it for space heating, domestic water heating, or another process requirement. Heat recovery has been successfully applied in virtually all types of buildings, including hotels, schools, manufacturing plants, and office buildings. It typically provides an attractive return on investment for building owners. The use of heat recovery should be considered in any building with simultaneous heating and cooling requirements, or in facilities where the heat can be stored and used at a later time. Buildings with high year-round internal cooling loads are excellent opportunities for heat recovery.

Additionally, ASHRAE/IESNA Standard 90.1–1999 (Section 6.3.2) includes restrictions on the amount of reheat that can be performed in an HVAC system unless it is recovered heat. It is therefore likely that heat recovery will be used more in the future.

Heat recovery can be applied to practically any type of water chiller. It can be accomplished either by operating at higher condensing temperatures and recovering heat from the water leaving the standard condenser, or by using a separate condenser, as shown in Figure 76 for a centrifugal chiller. In smaller chillers, heat recovery is sometimes accomplished using a device called a desuperheater. A desuperheater is a device that is connected to the refrigeration circuit between the compressor and condenser to recover heat from the hot refrigerant vapor.

period three

System Variations

notes

Heat-Recovery Chiller Options

heat-recovery (dual) condenser	auxiliary condenser	heat pump
◆ Second, full-size condenser	◆ Second, smaller-size condenser	◆ No extra condenser
◆ Large heating loads	◆ Preheating loads	◆ Large base-heating loads or continuous operation
◆ High hot-water temperatures	◆ Moderate hot-water temperatures	◆ High hot-water temperatures
◆ Controlled	◆ Uncontrolled	◆ Controlled
◆ Degrades chiller efficiency	◆ Improves chiller efficiency	◆ Good heating efficiency

Figure 77

For water-cooled centrifugal chillers, there are generally three methods of implementing heat recovery.

The **dual-condenser, or double-bundle, heat-recovery chiller** contains a second, full-size condenser that is connected to a separate hot-water loop. It is capable of more heat rejection and higher leaving-hot-water temperatures than an auxiliary condenser. The amount of heat rejected is controlled by varying the temperature or flow of water through the standard condenser. Chiller efficiency is degraded slightly in order to reach the higher condensing temperatures.

An **auxiliary-condenser, heat-recovery chiller** makes use of a second, but smaller, condenser bundle. It is not capable of rejecting as much heat as the dual-condenser chiller. Leaving hot-water temperatures are also lower, so it is often used to preheat water upstream of the primary heating equipment or water heater. It requires no additional controls, and actually improves chiller efficiency because of the extra heat-transfer surface for condensing.

A **heat-pump chiller** is a standard chiller (no extra shells are required) used and controlled primarily for the heat it can produce in the condenser. The evaporator is connected to the chilled-water loop, typically in the sidestream position discussed earlier, but it only removes enough heat from the chilled-water loop to handle the heating load served by its condenser. This application is useful in a multiple-chiller system where there is a base or year-round heating or process load, or where the quantity of heat required is significantly less than the cooling load. The heating efficiency of a heat-pump chiller is the highest of any heat-producing device.

period three

System Variations

notes

Heat-Recovery Chiller Efficiency

chiller type	cooling mode	heat-recovery mode
cooling-only centrifugal chiller	0.57 kW/ton [6.2 COP]	not applicable
heat-recovery centrifugal chiller	0.60 kW/ton [5.9 COP]	0.69 kW/ton [5.1 COP]

- cooling mode conditions:**
- evaporator $\Delta T = 44^{\circ}\text{F}$ to 54°F [6.7°C to 12.2°C]
 - condenser $\Delta T = 85^{\circ}\text{F}$ to 95°F [29.4°C to 35.0°C]
- heat-recovery mode conditions:**
- evaporator $\Delta T = 44^{\circ}\text{F}$ to 54°F [6.7°C to 12.2°C]
 - condenser $\Delta T = 85^{\circ}\text{F}$ to 105°F [29.4°C to 40.6°C]

Figure 78

There is usually an efficiency penalty associated with the use of heat recovery with a chiller. The cost of this efficiency penalty, however, is typically much less than the energy saved by recovering the “free” heat.

The energy consumption of a heat-recovery chiller will be higher than that of a cooling-only chiller, because of the higher pressure differential at which the compressor must operate. In this example, the energy consumption of a centrifugal chiller operating in heat-recovery mode (producing 105°F [40.6°C] condenser water) is 0.69 kW/ton [5.1 COP]. The efficiency of the same chiller operating in the cooling-only mode (no heat being recovered and producing 95°F [35°C] condenser water) is 0.60 kW/ton [5.9 COP]. A comparable cooling-only chiller of the same capacity and operating at the same cooling-only conditions consumes 0.57 kW/ton [6.2 COP]. In this example, the heat-recovery chiller uses four percent more energy in the cooling-only mode than the chiller designed and optimized for cooling-only operation. It is therefore important to perform a life-cycle cost analysis to determine when heat recovery is a viable option.

It should also be noted that the chiller can only recover the amount of heat transferred into the evaporator plus the energy input to the compressor. Therefore, the more load on the chiller evaporator, the more heat can be recovered. To maximize the heat available for recovery, a heat-recovery chiller is often piped in one of the preferential-loading configurations described earlier. An advantage of the sidestream position is that the heat-recovery chiller is not required to maintain a chilled-water temperature set point. It can be loaded just enough to satisfy the heating load while the more efficient cooling-only chillers provide the rest of the cooling. The heat removed from the chilled-water loop benefits the system by precooling the return water.

period three

System Variations

notes

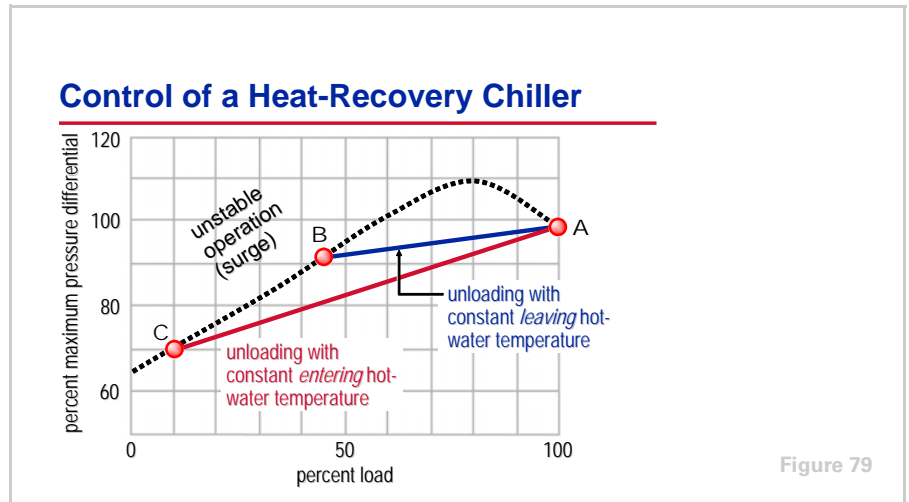

The control of a heat-recovery centrifugal chiller, although seemingly simple, is critical to reliable chiller operation. Typically, either the temperature or the flow of the water entering the standard condenser is modulated to meet the capacity required by the heat-recovery condenser.

Controlling heat-recovery capacity based on the temperature of the hot water *leaving* the heat-recovery condenser can cause operational problems for a centrifugal chiller. This is explained best by using a map of centrifugal-compressor operation (see Figure 79). Control based on the temperature of the water leaving the heat-recovery condenser causes the condenser-to-evaporator pressure differential to remain relatively high at all loads (line **A** to **B**). High pressure differentials at low cooling loads increases the risk of a centrifugal compressor operating in its unstable region, commonly known as surge.

The preferred method is to control heat-recovery capacity based on the temperature of the hot water *entering* the heat-recovery condenser. This allows the condenser-to-evaporator pressure differential to decrease as the chiller unloads (line **A** to **C**), thereby keeping the centrifugal chiller from surging and resulting in more stable operation. If high leaving-hot-water temperatures are required at low-cooling-load conditions, another method to prevent surge is to use hot gas bypass on the centrifugal chiller.

For other types of chillers that are not prone to surge, operating at these high pressure differentials at low cooling loads may cause the chiller to consume more energy than it recovers in the form of heat.

period three

System Variations

notes

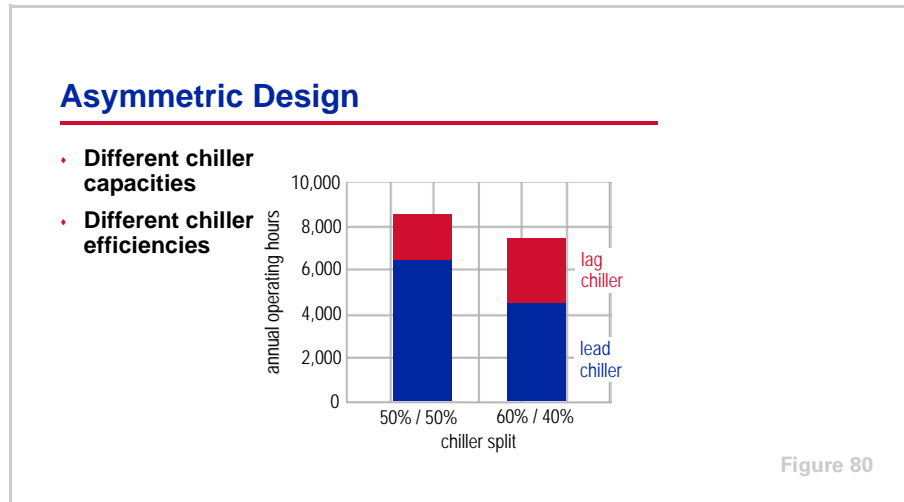

Asymmetric Design

Many system design engineers seem to default to using chillers of equal capacity in a multiple-chiller system. There are benefits to using chillers of varying capacities to more favorably match the system loads. Remember that when a chiller is started, so is the associated ancillary equipment (pumps and cooling tower). In general, the smaller the chiller, the smaller the ancillary equipment. Operating the least number of chillers, and the smallest chiller possible, to meet the system load minimizes *system* energy consumption.

Figure 80 examines the use of a “60/40 split,” that is, one chiller (the “lead” chiller) is sized for 40 percent of the total system capacity and the second chiller (the “lag” chiller) for 60 percent. Notice that the number of hours of chiller (and ancillary equipment) operation is reduced by 15 percent, by changing from two chillers of equal capacity to one chiller at 40 percent capacity and the second chiller at 60 percent. This is because up to 60 percent load, only one chiller is operating. Below 40 percent load, only the lead chiller is operating; between 40 and 60 percent load, only the lag chiller is operating. In the same system with chillers of equal capacity, both chillers and their ancillary equipment are operating when the load is 50 percent or greater.

period three
System Variations

notes

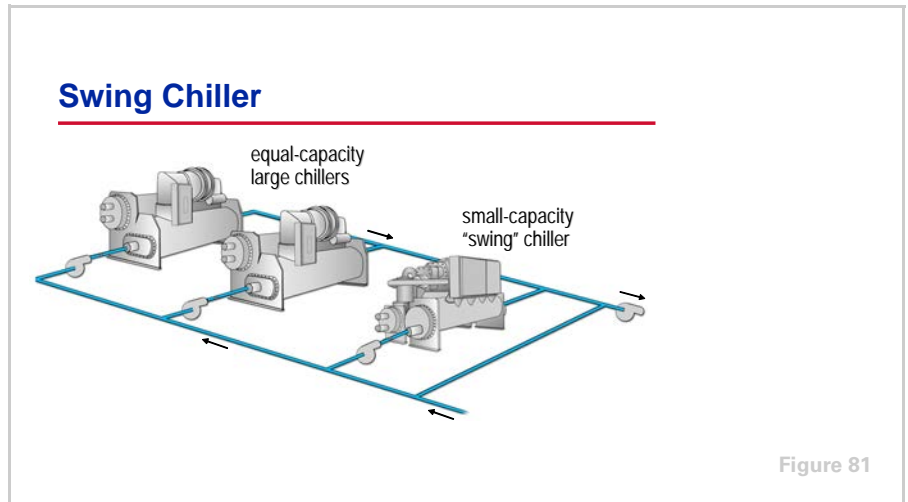

Another benefit of unequal chiller capacities is that the system load can be more closely matched with the operating chiller (and ancillary equipment) capacity, increasing overall system efficiency.

Figure 81 shows a system that includes two large chillers of equal capacity, along with one smaller capacity chiller. The smaller capacity chiller, called a **swing chiller**, in this combination presents an opportunity for significant, overall system-energy savings.

period three

System Variations

notes

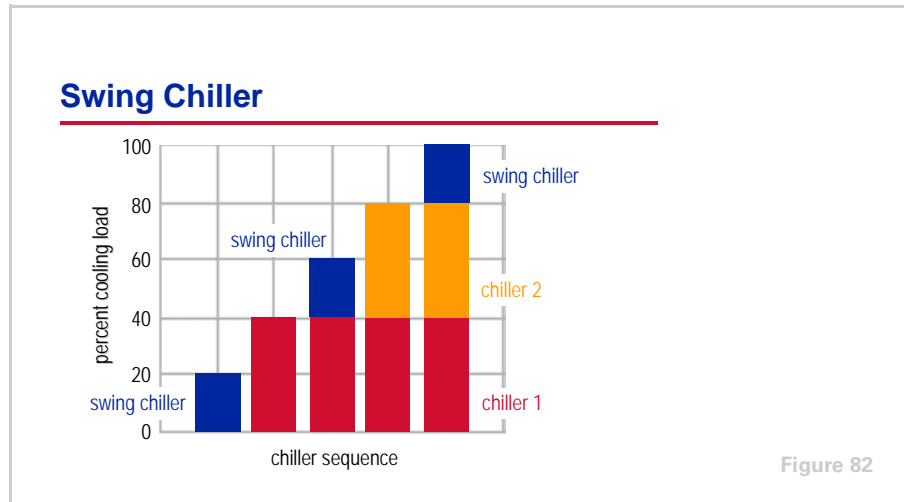

Figure 82

The smaller swing chiller is turned on to handle the low cooling loads either during the night or during unoccupied periods of time. When the building load exceeds the capacity of the swing chiller, it is turned off and a larger chiller is turned on. The larger chiller handles the building cooling load alone until it becomes fully loaded. Then the swing chiller is turned on again. The swing chiller is alternated on and off between the larger chillers' operation to serve as a smaller incremental step of loading. This sequence more favorably matches the capacity of the chiller plant to the system load. It keeps the large chillers loaded in their peak efficiency range and operates with the fewest, and smallest, pieces of ancillary equipment (pumps and cooling towers) at any system load.

A common concern is to prevent the swing chiller from cycling too frequently, which could shorten the life of the equipment. In large chilled-water systems, however, the changes in building load typically occur slowly enough that this is not a problem.

A final asymmetric design option is to use one high-efficiency chiller and one or more standard-efficiency chillers. In this type of system, the high-efficiency chiller should be preferentially loaded to minimize system energy consumption.

period three

System Variations

notes

“Free” Cooling

- **Airside economizer**
- **Waterside economizer**
 - ◆ Strainer cycle
 - ◆ Plate-and-frame heat exchanger
 - ◆ Refrigerant migration

Figure 83

“Free” Cooling

There are a number of methods that use cool outdoor conditions to reduce cooling energy costs. They are often referred to as “free cooling” because they reduce or eliminate the energy consumed by the compressor. They are not truly free, but really reduced-cost cooling options.

The most prevalent method is the use of an **airside economizer**. When the temperature, or enthalpy, of the outdoor air is low enough, the outdoor-air and return-air dampers in the air handler are modulated and the cooler outdoor air is used to reduce the temperature of air entering the cooling coil. This can reduce or totally eliminate the requirement for mechanical cooling for much of the year in many climates.

In water-cooled systems, there are also several types of **waterside economizers**. The most direct method, but typically the least desirable, is to use a **strainer cycle**. In this system, the condenser- and chilled-water systems are connected. When the outdoor wet-bulb temperature is low enough, cold water from the cooling tower is routed directly into the chilled-water loop. Although the strainer cycle is the most efficient waterside economizer option, it greatly increases the risk of fouling in the chilled-water system and cooling coils with the same type of contamination that is common in open-cooling-tower systems. A strainer or filter can be used to minimize this contamination, but the potential for fouling prevents widespread use of the strainer-cycle system.

period three

System Variations

notes

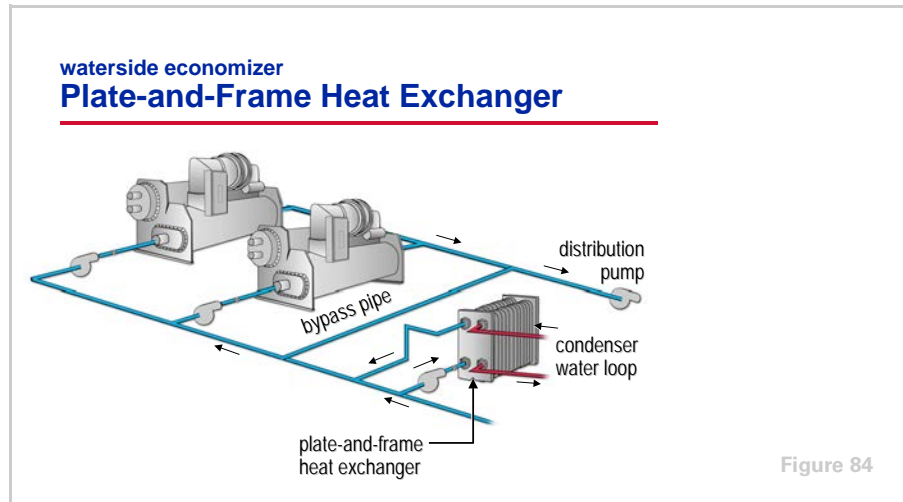

A second type of waterside economizer is the **plate-and-frame heat exchanger**. In this case, water from the cooling tower is kept separate from the chilled-water loop by a plate-and-frame heat exchanger. This is a popular configuration because it can achieve a high heat-transfer efficiency without the potential for cross-contamination. With the addition of a second condenser-water pump and proper piping modifications, this heat exchanger can operate simultaneously with the chiller. As much heat as possible is rejected through the heat exchanger, while the chiller handles any excess cooling load.

If the plate-and-frame heat exchanger is piped in the sidestream position, it can be used for more hours in the year because it does not need to maintain a leaving-chilled-water temperature set point. It can provide some useful cooling at any time that it can precool the system return water.

If simultaneous free cooling and mechanical cooling are performed, care must be taken to control the evaporator-to-condenser pressure differential inside the chiller. When very cold condenser water flows through the chiller condenser for an extended period of time, operational problems may result due to a low pressure differential between the evaporator and the condenser. Using a three-way, modulating bypass valve to mix the warm water leaving the chiller condenser with the cold water entering the condenser, or a two-way modulating valve and a variable-speed condenser water pump, can eliminate this problem. Consult with the chiller manufacturer to determine the limits for the specific chiller being used. This issue is discussed further in Period Four.

period three

System Variations

notes

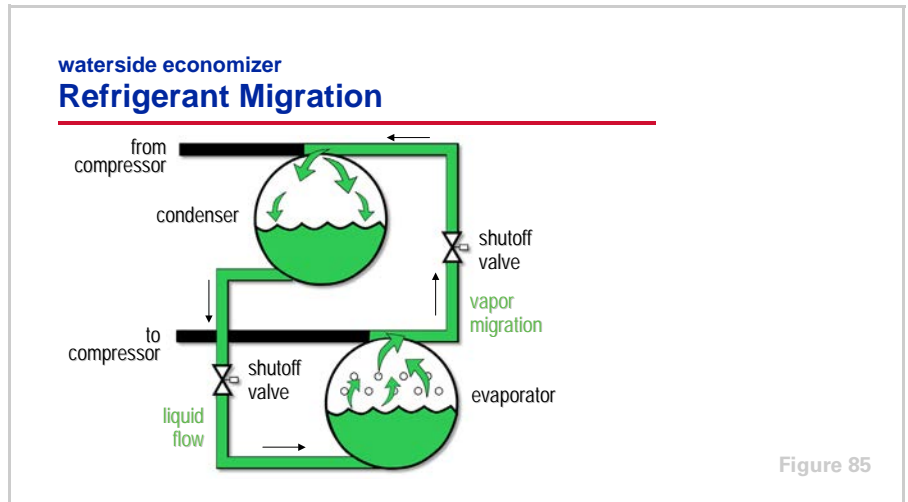

The final method of “free” cooling is to transfer heat between the cooling tower water and the chilled water inside a centrifugal chiller through the use of **refrigerant migration**. When the temperature of the water from the cooling tower is colder than the desired chilled-water temperature, the compressor is turned off and automatic shutoff valves inside the chiller refrigerant circuit are opened. This allows refrigerant to circulate between the evaporator and condenser without the need to operate the compressor. Because refrigerant vapor migrates to the area with the lowest temperature, refrigerant boils in the evaporator and the vapor migrates to the cooler condenser. After the refrigerant condenses into a liquid, it flows by gravity back into the evaporator.

There are no additional fouling concerns because the cooling-tower water flows through the chiller condenser and is separated from the chilled-water loop.

Although not as effective as a plate-and-frame heat exchanger, it is possible for refrigerant migration in a centrifugal chiller to satisfy many cooling load requirements (up to 40 percent of the chiller’s design capacity) without operating the compressor. This can increase further if the system can accommodate warmer chilled-water temperatures at part-load conditions.

period three

System Variations

notes

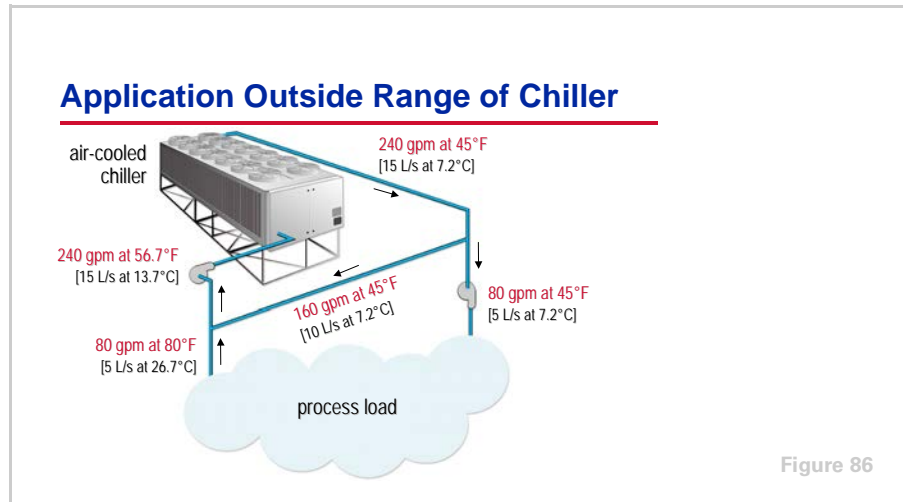

Application Outside the Operating Range of the Chiller

Some process-load applications involve either temperatures or flow rates that are outside the capabilities of any chiller. This may include high return-water temperatures, high or low fluid flow rates, or high or low system ΔT s. By using special piping arrangements, a standard chiller can still be used to satisfy the requirements of the process load.

Figure 86 shows a system in which the water flow requirement of the process load is below the minimum flow rate for a chiller with the required capacity. The system is designed like a primary-secondary system, but the production loop has a higher design flow rate than the distribution loop. This allows the water flow rate and ΔT through the chiller to be within the acceptable limits, while the water flow rate and ΔT through the process meet its requirements.

Alternatively, in a smaller system with a single chiller, a single pump on the chiller side of the bypass and a diverting valve to maintain the proper flow through the process load can achieve the same result.

period four
Chiller-Plant Control

notes

Chilled-Water Systems

period four

Chiller-Plant Control

Figure 87

It is important to understand that no matter how good the system design is, adequate controls are necessary for all the components to operate properly as a system. It is equally important to understand that you cannot “control your way out of a bad system design.”

The chiller plant consists of chillers, pumps, pipes, coils, cooling towers, temperature sensors, control valves, and many other devices. It is similar to an orchestra with many instruments. The existence of these pieces does not guarantee that the system will work properly. There needs to be an orchestra conductor. In the case of a chilled-water system, that conductor is a chiller-plant control system. How well the plant works depends on how well the control system gets all the pieces to work together.

period four

Chiller-Plant Control

notes

Chiller Controls

- Start-stop
- Chilled-water temperature control
- Monitor and protect
- Adapt to unusual conditions



Figure 88

The largest change to chillers in the last decade has undoubtedly been in the area of controls. In the past, chillers were pneumatically controlled, and they were protected by turning them off if the flow rates or temperatures changed too quickly. Today's microprocessor-based controls provide accurate chilled-water temperature control, as well as monitoring, protection, and adaptive limit functions.

These controls monitor chiller operation and prevent the chiller from operating outside its acceptable limits. They can also adapt to unusual operating conditions, keeping the chiller operating by modulating its components and sending a warning message, rather than doing nothing more than shutting it down when a safety setting is violated. Improved control accuracy allows chillers to be applied in systems and applications that were previously avoided. When problems occur, diagnostic messages aid troubleshooting. Modern chiller controls also interface with a chiller-plant control system for integrated system operation.

period four
Chiller-Plant Control

notes

What Is Important?

- When to turn a chiller on or off
- Which chiller to turn on or off
- How to recover from an equipment failure
- How to optimize system efficiency
- How to communicate with the operator

Figure 89

There are primarily five issues to address in a chiller-plant control system.

- 1** When should a chiller be turned on or off?
- 2** After we know that a chiller must be turned on or off, which one should it be?
- 3** If we attempt to turn on a chiller, pump, or cooling tower, and there is a malfunction, what do we do next?
- 4** How can we minimize the energy cost of operating the system?
- 5** How can the chiller-plant control system effectively communicate with the operator?

period four

Chiller-Plant Control

notes

Chiller Sequencing

- Turning on an additional chiller
- Turning off a chiller
- Which chiller to turn on or off?

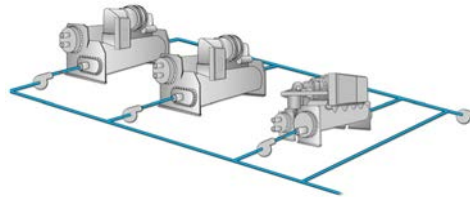

Figure 90

Chiller Sequencing

Chiller sequencing refers to making decisions about when to turn chillers on and off, and in what order. Typically, turning chillers on and off is performed with the goal of matching the capacity of the chiller plant to the system cooling load. In order to do this successfully, the design of the chilled-water system must provide the control system with variables that are good indicators of system load.

The hydraulic design and size of the chilled-water system will determine the possible method(s) for effectively monitoring system load. Typical methods for load monitoring include:

- In series- or parallel-piped systems, the supply- and return-water temperatures, and sometimes chiller current draw, are monitored.
- In a primary-secondary system, the system supply and chiller return-water temperatures and/or the direction and quantity of flow in the bypass pipe are typically measured.
- In a variable-primary-flow system, the system supply-water temperature and the system flow rate may be monitored.
- Direct measurement of the system load (in tons, kW, or amperes) has also been used in some systems.

Other methods are also possible. It is imperative that the chilled-water system be designed with the control variables in mind; otherwise, the result may be a system that is impossible to efficiently control.

period four

Chiller-Plant Control

notes

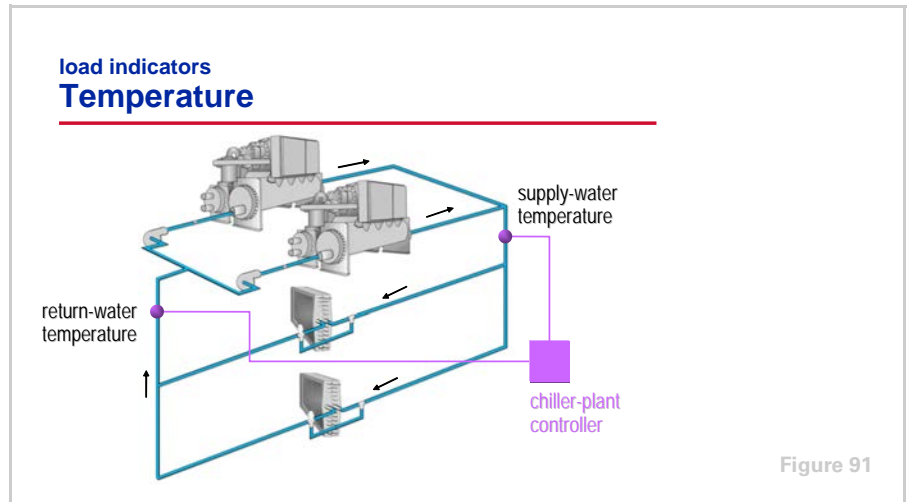

Today's chiller controls can very accurately control the chiller's leaving-water temperatures over a wide range of loads. This is especially true of centrifugal and helical-rotary chillers. This fact allows constant-flow chilled-water systems, similar to the system shown in Figure 91, to use the system supply- and return-water temperatures to determine system load.

By sensing a rise in the temperature of the water leaving the chiller plant, the control system can determine when the operating chillers can no longer maintain the desired temperature. Often, the supply-water temperature is allowed to drift a predetermined amount before an additional chiller is turned on, to ensure that there is enough load to keep an additional chiller operating.

Deciding when it is appropriate to turn a chiller off is more complex. The control system may monitor the system ΔT , that is, return-water temperature minus supply-water temperature. This information, along with the capacities of the operating chillers, allows the control system to determine when a chiller can be turned off. To help stabilize system operation, the control system should use logic to prevent load transients from causing unwarranted chiller cycling.

In constant-flow systems that are suffering from "low ΔT syndrome" (airside systems that return water to the plant at lower temperatures than desired), some of the load terminals may starve for flow before the capacity of the operating chiller is exceeded. To preserve system efficiency, this situation is best dealt with by solving the airside problem. Typical causes of low ΔT syndrome include: a poorly-balanced flow system, dirty filters or coils, poorly performing air-handler controls, incorrect coil control valves, or undersized air handlers.

period four

Chiller-Plant Control

notes

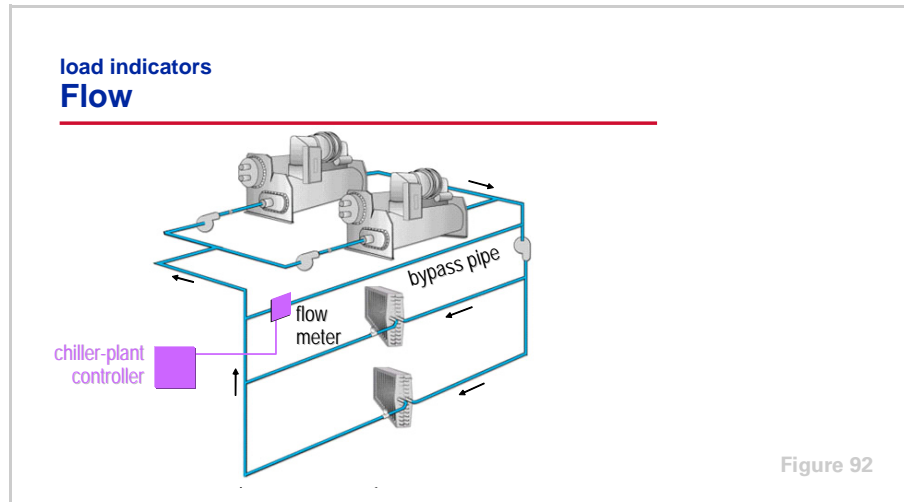

In a primary-secondary system, the direction and quantity of flow in the bypass pipe is an excellent indicator of when to turn a chiller on or off. As discussed in Period Two, the water flow in the bypass pipe can be measured directly using a flow meter, or indirectly by measuring system water temperatures and applying flow-mixing equations. The rules applied to the bypass flow to determine when to turn a chiller on and off are:

- When there is a deficit flow, a chiller may be added.
- When there is excess flow greater than that of the next chiller to be turned off, plus a 10 to 15 percent safety factor, that chiller may be turned off.
- If neither of the above conditions exists, do nothing.

As an alternative to measuring flow in a primary-secondary system with four or less chillers, system supply and chiller-plant return-water temperatures may be used to decide when to turn a chiller on or off. This is similar to the logic applied to constant-flow systems. It is simple and has a low installed cost, but it is less accurate than flow determination, especially as the number of chillers increases.

“Low ΔT syndrome” can also affect the operation of primary-secondary systems. Unlike constant-flow systems, the primary-secondary system will maintain the required system flow and supply-water temperature, and therefore maintain occupant comfort. However, it accomplishes this by turning on additional chillers before all operating chillers are fully loaded. This may reduce overall system efficiency.

Although some have proposed solutions such as putting a valve in the bypass line, lowering the supply-water temperature, or controlling the system differently, these are only band-aids that mask the actual problem and often cause other operational difficulties. Fixing the root cause of low ΔT syndrome in the distribution system is the best course of action for proper and efficient system operation.

period four

Chiller-Plant Control

notes

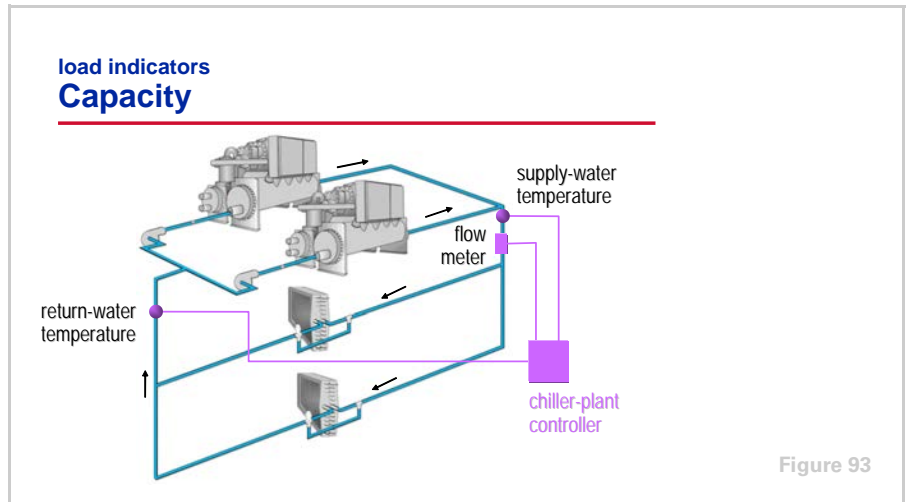

Another method of monitoring system cooling load is to measure the system water flow rate and temperatures directly, and then calculate the load. Although it would appear that direct measurement of the actual system load would be an excellent way to determine when to turn chillers on and off, this method has several drawbacks. It requires the use of flow meters with high accuracy and high turndown capacities. Although flow meters have become more accurate and less expensive, they require special installation conditions for reliable accuracy—conditions seldom achievable in real installations. Also, the equipment typically requires regular calibration. For these reasons, direct measurement of load has not been used as much as the simple and reliable methods discussed previously.

An alternate way to monitor chiller load is by measuring the current draw of the chiller motor. By itself, this does not provide an adequate control indicator, but when used in conjunction with other information, such as system supply-water temperature, it can be effective. System supply-water temperature is used to determine when to turn an additional chiller on, and operating chiller compressor-motor current draw is used to determine when a chiller can be turned off.

The most effective load indicator for any chilled-water system is dependent on the design of that system. Creative designers have used the control strategies as described here and in various combinations to effectively control a wide variety of chiller plants. It is highly recommended that one of the first tasks undertaken in the design process is to create a simplified flow diagram and a load model of the system that allows for the evaluation of various control strategies and sensor placements. This will help to ensure that effective chiller-plant control can be implemented.

period four

Chiller-Plant Control

notes

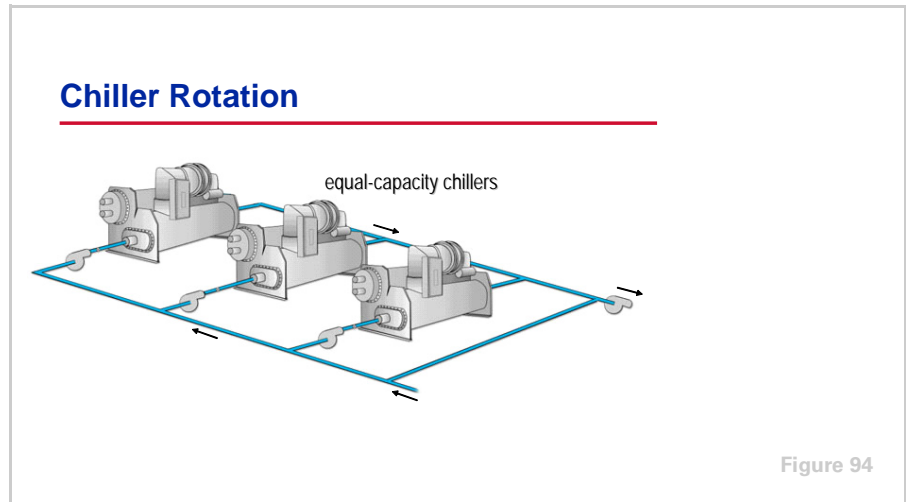

When the system has determined that a chiller needs to be turned on or off, the next issue is to determine the sequence in which to turn chillers on and off. It is assumed that the first chiller in the sequence will always be turned on whenever cooling is required.

When the system consists of identical chillers, the choice of which chiller is turned on or off next has little impact on system efficiency. Some design engineers and operators prefer to equalize the run time and the number of starts for all chillers in the system. This is typically done by rotating the sequence of chillers on a periodic basis, often every few days or weeks. This method generally keeps the run time equalized reasonably well, and the operator knows exactly when to expect the rotation to occur. An alternative approach is to total the actual run hours on each chiller, in an attempt to rotate the chillers when a significant imbalance in the run time or the number of starts occurs. Rotation that is based on actual run time has the disadvantage of the operator not knowing when rotation will occur. In some installations, operating personnel prefer to manually initiate rotation.

On the other hand, some design engineers and operators believe that equalizing run times will result in all of the chillers needing to be overhauled or replaced at the same time. They tend to operate the most-efficient chiller first, followed by the next-most-efficient, and so on. With this approach, all chillers are turned on at least once a month to ensure that they will be able to start when required.

period four

Chiller-Plant Control

notes

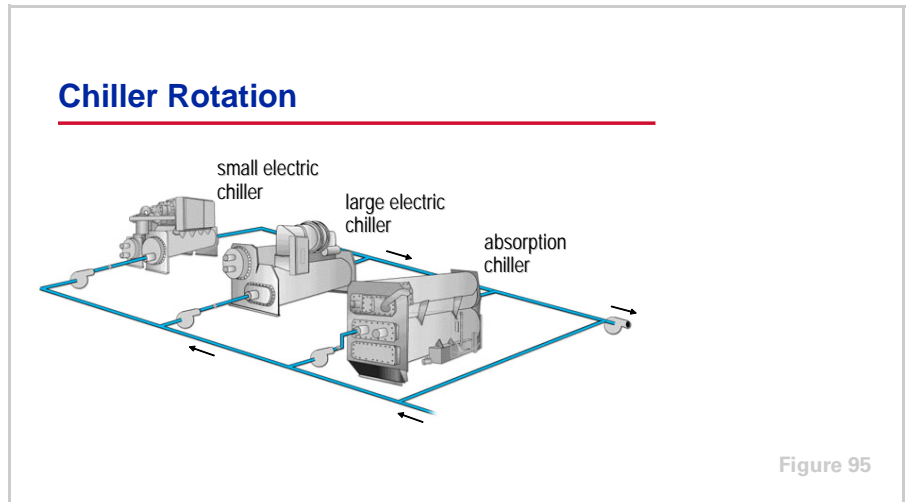

When the system consists of chillers with different capacities, efficiencies, or fuel types, the question of which chiller to turn on or off next becomes more complex. Although each system requires a complete analysis, there are some general principles that apply to most systems.

In systems with chillers of different capacities, such as the “swing” chiller concept introduced in Period Three, the goal is to operate the least number of chillers and the smallest chiller possible. This typically minimizes overall system energy consumption by closely matching the capacity of the plant to the system load, thus reducing the energy used by ancillary equipment.

In systems with chillers of different efficiencies, it makes sense to operate the most efficient chillers first and the least efficient chillers last. If different fuel types are involved, the control system may receive data on the costs of natural gas and electricity and calculate the real-time cost of operating the electric-versus gas-driven chillers.

period four
Chiller-Plant Control

notes

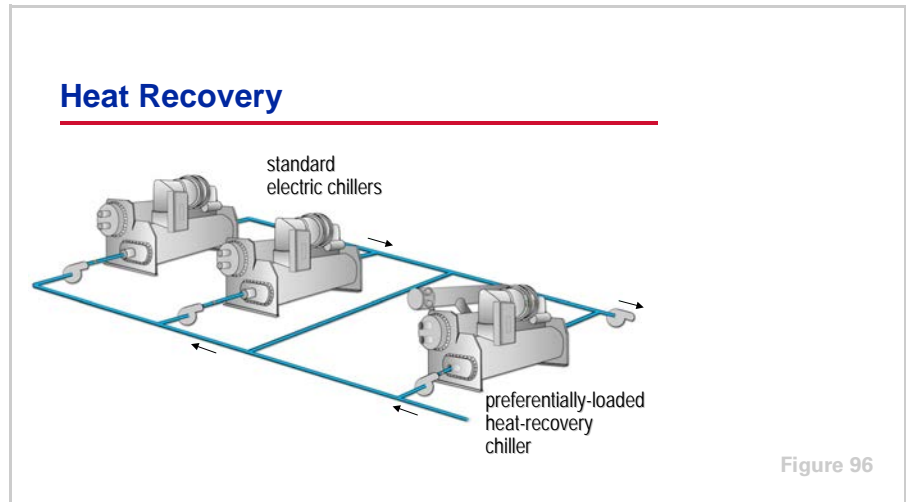

The system might also benefit from having a heat-recovery chiller fully loaded. As discussed in Period Three, to maximize the amount of heat recovered, it is often desirable to preferentially load that chiller, sequencing it as a base chiller—“first on” and “last off.” Other chillers can then be turned on when the heat-recovery chiller cannot handle the cooling load alone.

A variation on this idea is an absorption chiller fueled by waste heat. It is preferentially loaded to handle as much of the cooling load as possible before turning on other chillers. The absorption chiller would be sequenced as a base chiller to make use of the free energy operating this chiller.

period four

Chiller-Plant Control

notes

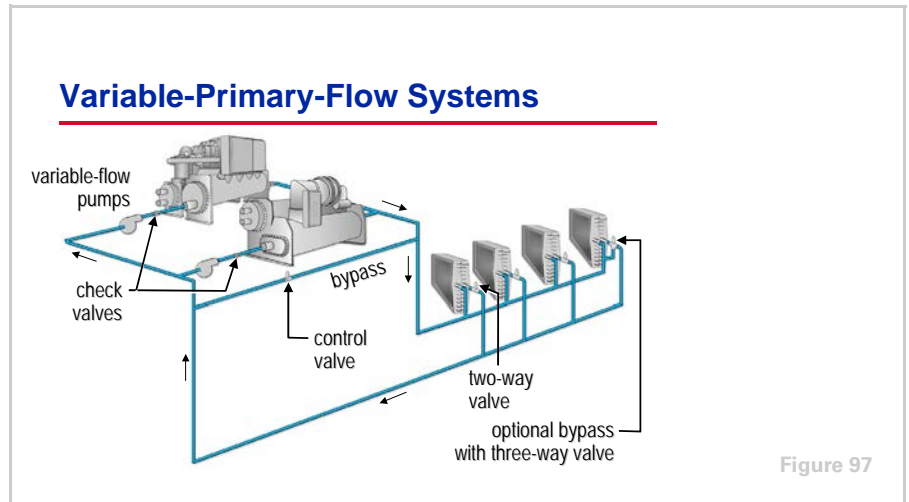

The variable-primary-flow system, introduced in Period Three, is designed to operate with variable flow through the chiller evaporators. Sequencing chillers in this type of system cannot be based solely on temperature, because in a properly-operating system the supply- and return-water temperatures will be nearly constant. Determining when to turn chillers on or off is not a simple task. For control stability and chiller reliability, the flow rates through the chillers, and the rate of flow change, must be kept within allowable ranges.

Therefore, control of a variable-primary-flow system must:

- Include a method to determine system load. Many systems measure flow rates and temperatures.
- Ensure that flow rates through the chillers are within the allowable minimum and maximum limits. Modulation of a control valve in the bypass pipe is commonly used to ensure minimum flow rates through the chillers.
- Control the rate at which the system flow rate changes, to ensure that it does not change more rapidly than the chillers can adapt. This is especially critical when turning on additional chillers.

Adequate time must be spent designing the control sequence and commissioning the system after installation, to ensure proper operation of a variable-primary-flow system.

period four

Chiller-Plant Control

notes

System Failure Recovery

- **Maintain flow of chilled water**
- **Keep it simple**
 - ◆ Lock out failed equipment
 - ◆ Turn on the next chiller in the sequence
- **Notify the operator**
- **Allow the operator to intervene**

Figure 98

Failure Recovery and Contingency Planning

In addition to normal chiller sequencing, the chiller-plant control system must react when a chiller or another piece of associated equipment fails. Failure recovery, or ensuring the reliable supply of chilled water, is a very important part of the chiller-plant control system, and is an area where many systems have fallen short. This is especially true in field-programmed systems because of the difficulty of thorough debugging.

During periods of equipment malfunction, it is important to focus on the primary goal of the system, which is to provide the required flow of chilled water to the system at the proper temperature. It seems reasonable that the simplest and most reliable failure-recovery sequence is to simply turn on the next chiller in the sequence, and not try to turn several chillers on and off in an attempt to re-optimize the system.

During an equipment failure, it is especially important to notify the operator of the status, as well as to help the operator understand where the problem is and what might be the cause. The control system must also allow the operator to easily analyze the situation and to intervene if the failure condition will exist for an extended period of time. A system that provides this information will ensure that the system itself will be maintained and operated in proper condition.

period four

Chiller-Plant Control

notes

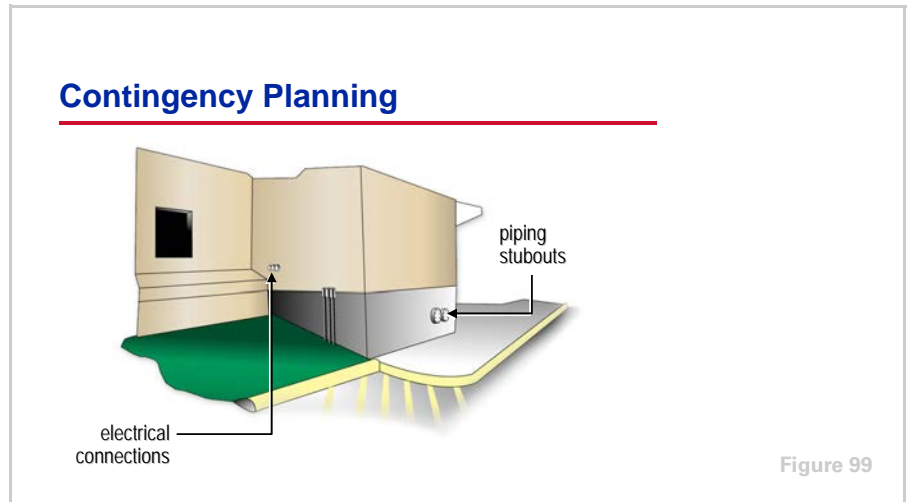

In addition to failure recovery, it is wise for the system design engineer to work with the building owner to develop a contingency plan for chilled water in the case of an emergency shutdown or an extended breakdown. Many organizations have contingency plans for critical areas of their business. Some deal with natural disasters and others with the loss of power in critical areas. However, few have taken the time to think about what a loss of cooling would mean to their facility. This is often especially critical for process-cooling applications.

Cooling contingency planning is intended to minimize the losses a facility may incur as a result of a total or partial loss of cooling capacity. It allows a building operator to act more quickly by having a plan in place and by proactively preparing the facility. Such a plan often includes working with suppliers to temporarily lease cooling equipment. During initial construction, it is easy and cost-effective to provide piping stubs, which are built into the chilled-water system for quick connection, and easily accessible electrical connections. When equipment leasing is combined with these simple additions to the system, a contingency plan can be put into action quickly and the system can produce chilled water again in a short period of time.

It is important to first identify the minimum, or critical, cooling capacity required. With multiple chillers in a facility, it may be acceptable to have less than full capacity in an emergency situation. For example, the chiller plant may consist of 1,800 tons [6,330 kW], but the minimum capacity required in an emergency situation may only be 1,200 tons [4,220 kW]. Therefore, it is also important to identify a contingency plan if Chiller 1 fails, if Chiller 2 fails, if Chillers 2 and 3 fail, and so on.

period four

Chiller-Plant Control

notes

System Timers

- **Load-confirmation timer**
 - ◆ Avoids transient conditions
- **Staging-interval timer**
 - ◆ Allows time for the system to respond to turning a chiller on
- **Minimum-cycle timer**
 - ◆ Prevents excessive cycling



Figure 100

System Tuning

In addition to turning chillers on and off, there are other functions of the chiller-plant control system that help prevent system flow instability from disrupting chiller operation. Flow instability can often be caused by normal valve and pump operation. The first is time delays.

Excessive cycling can be detrimental to the life of a motor. For this reason, turning a large motor (such as those used in large chillers) on and off should be minimized. Chilled-water systems typically have a large thermal mass (water in the system) and benefit from the diversity and slow rate of change of the system cooling load. Fast reactions, therefore, are typically not required. In fact, a response that is too fast will often cause system instability, waste energy, and cause unnecessary wear on mechanical equipment. To achieve stable and accurate control, many chiller-plant control systems provide time delays that can be adjusted by the operator to help minimize chiller cycling.

The first time delay is the **load-confirmation timer**. Its purpose is to delay turning on an additional chiller for a period of time following the initial indication that an additional chiller is required. This confirms that the indicated load is not a transient condition that would cause the chiller to be turned on and then quickly turned off.

The second time delay, which works in conjunction with the first, is a **staging-interval timer**. Its purpose is to allow the system time to respond after a chiller has been turned on. This prevents more chillers from turning on than are actually required, particularly during periods of pull-down or rapid load variation.

The third time delay is a **minimum-cycle timer**. This timer should have the highest priority. It requires a fixed period of time between turning an individual chiller on and turning it back off. This ensures that the chiller is not cycled too frequently.

It is important to understand that these timers are lower priority than the safeties built into the individual chiller controls. At all times, the individual

period four

Chiller-Plant Control

notes

chiller safeties must be capable of shutting the chiller down to avoid equipment damage.

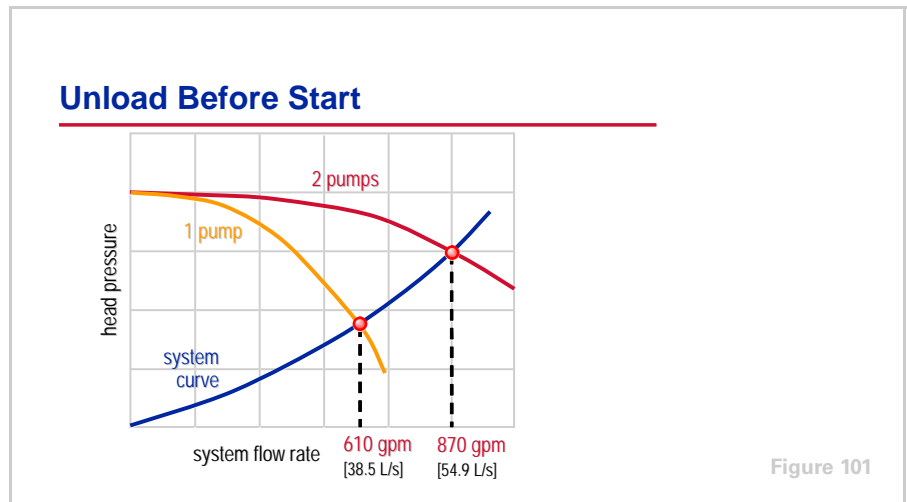

The next control function is to partially unload the operating chillers before an additional chiller and pump are turned on. Depending on the system configuration, there can be very rapid variations in water flow through the chiller evaporator when a pump is turned on or off, or when a control valve is opened or closed. Partially unloading the chiller prior to such variations allows the chiller to continue to operate without interruption.

This can be explained by looking at a flow diagram for a chilled-water system with multiple pumps (see Figure 36). This diagram shows that, with one pump and chiller operating, the flow rate through the chiller is 610 gpm [38.5 L/s]. When the second, same-size pump and chiller are turned on, the flow rate through the system increases to 870 gpm [54.9 L/s], but the flow through each chiller drops to 435 gpm [27.4 L/s]. This is an instantaneous reduction of 175 gpm [11 L/s], or 30 percent, through the first chiller.

The temperature of the water leaving the chiller and the temperature of the refrigerant in the evaporator drop as a result of this drastic flow reduction. New, advanced chiller controls may allow the refrigerant temperature to drop below the fluid's freezing point for a brief period of time while the compressor unloads. The evaporator low-temperature safety may, however, turn off the chiller if the controls and compressor cannot react quickly enough.

The **“unload-before-start” function** partially unloads the operating chillers, raising the refrigerant temperature in the evaporator, before the flow reduction occurs. The chillers are allowed to reload as soon as the additional chiller is turned on.

period four

Chiller-Plant Control

notes

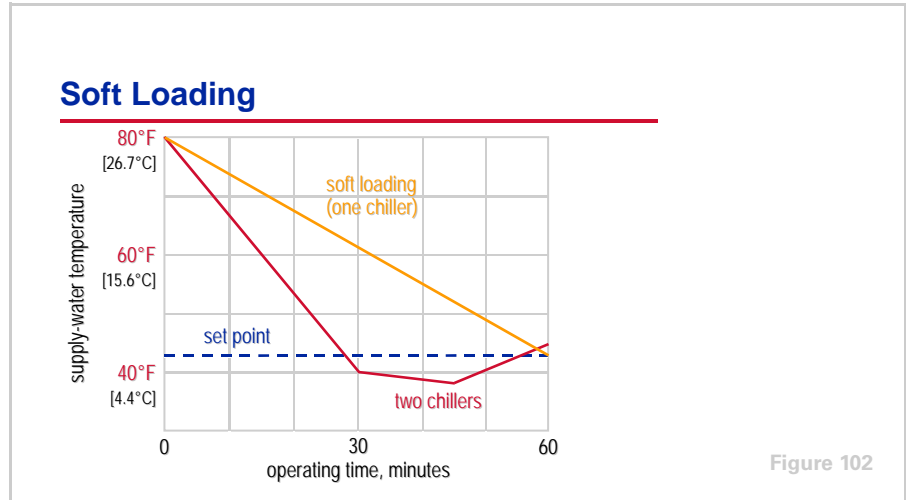

Another control function that is desirable is called **soft loading**. It is typically used when the system has been off for an extended period of time and the chilled-water temperature is the same as the ambient temperature inside the building.

Soft loading either delays turning on additional chillers or varies the chilled-water set point, allowing the operating chillers to gradually catch up to the building pull-down load. This results in a very smooth pull-down, prevents overshooting the set point, and operates only the equipment required to satisfy the actual system load.

period four

Chiller-Plant Control

notes

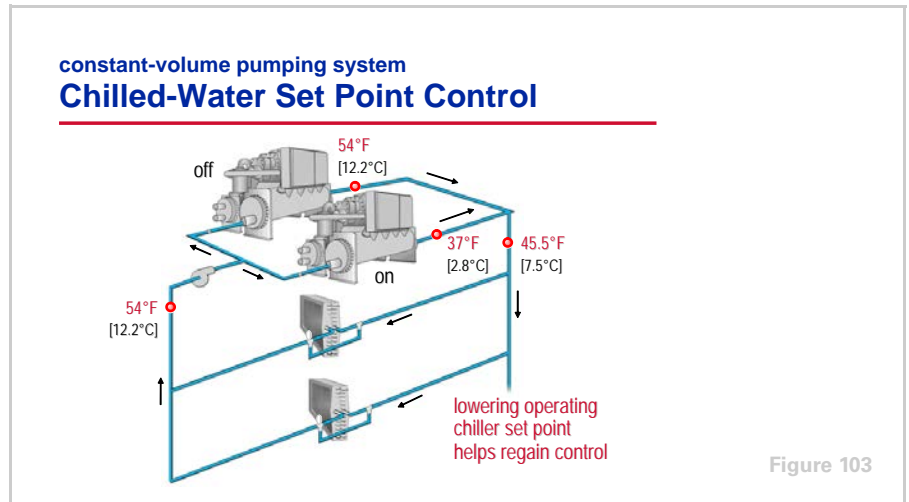

Constant-flow chilled-water systems frequently require individual chiller set-point control. Its purpose is to help maintain the system supply-water temperature by compensating for the bypass of return water through non-operating chillers.

The chiller-plant control system adjusts the individual set points for the operating chiller to “overcool” the water before it mixes with the higher-temperature water that bypasses through the non-operating chiller. The result is that the chilled water supplied to the system is as close as possible to the desired temperature. There are limits to the amount of overcooling. Depending on the design of the chilled-water system, one of two situations may exist. Either the chiller may not have been selected to produce cold-enough water, or the temperature required may be below the freezing point of the water being cooled. In either case, the control system must be intelligent enough to limit overcooling in order to prevent damage to the chiller.

Additionally, the control system must know when to turn another chiller on to meet the system chilled-water-temperature set point. Turning an additional chiller on may be required to meet the system demand for flow, even though the operating chiller may not be fully loaded.

period four

Chiller-Plant Control

notes

System Optimization

- **Chiller**
 - ◆ Decrease condenser-water temperature
 - ◆ Increase chilled-water temperature
- **Chilled-water pump (variable-flow system)**
 - ◆ Increase chilled-water ΔT
- **Cooling tower**
 - ◆ Increase condenser-water temperature
- **Condenser-water pump (variable-flow system)**
 - ◆ Increase condenser-water ΔT

Figure 104

System Optimization

The chiller-plant control system can also be used for system optimization. For the purposes of this discussion, we will define optimization as minimizing the energy used by the chiller plant (including chillers, chilled-water pumps, condenser-water pumps, and cooling tower) while still maintaining comfort or satisfying process loads.

The first step is to examine the energy use of the major components of the chiller plant, to see what can be done to minimize each component individually.

The chiller energy usage can be reduced by lowering the condenser-water temperature or by raising the chilled-water temperature.

In a variable-flow system, chilled-water pumping energy can be reduced by lowering the chilled-water temperature while increasing the system ΔT . With the lower water temperature and increased ΔT , the coil requires less water flow to handle the same load.

Cooling-tower energy can be reduced by increasing the condenser-water temperature. This allows the tower fans to cycle or slow down. Condenser-water pumping energy can be reduced by increasing the ΔT through the condenser side of the system, thereby pumping less water. This is achieved by reducing the water flow through the condenser.

Obviously, looking at only a single component presents a conflicting picture for energy reduction, and a change in one component has an impact on other components. To truly optimize the chiller plant, all components must be analyzed together.

period four

Chiller-Plant Control

notes

Chilled Water Reset

- **Pros**

- ◆ Reduces chiller energy
- ◆ Can work in constant-flow systems

- **Cons**

- ◆ Increases pump energy in variable-flow systems
- ◆ Can cause loss of space humidity control
- ◆ Complicates chiller sequencing control

Figure 105

As previously stated, as the chilled-water temperature set point is reset upwards, the chiller will use less energy. In constant-flow systems, this **chilled-water reset** strategy is fairly simple to implement and can be controlled based on the drop in return-water temperature.

In a variable-flow system, however, as the chilled-water temperature increases, the pumping energy also increases. While the COP of the chiller is approximately 6.5, the COP of the pump is about 0.65. Often the increase in pump energy will be more than the amount of chiller energy saved, especially because the chiller will often operate at part-load conditions. Another potential problem with resetting the chilled-water temperature upward is that space humidity control can be compromised if the water gets too warm. Finally, the chiller-plant control system must account for the changing supply-water temperature.

ASHRAE/IESNA Standard 90.1–1999 (Section 6.3.4.3) requires the use of chilled-water temperature reset in systems larger than 25 tons [88 kW]. It does, however, exclude variable-flow systems and systems where space humidity control will be compromised.

In Period Three, the concept of designing for reduced chilled-water temperature and flow rates was briefly discussed. Some engineers feel that designing the system for low flow rates and a lower supply-water temperature, thus minimizing pump energy use, might be a better answer than attempting to reset the temperature upward.

period four

Chiller-Plant Control

notes

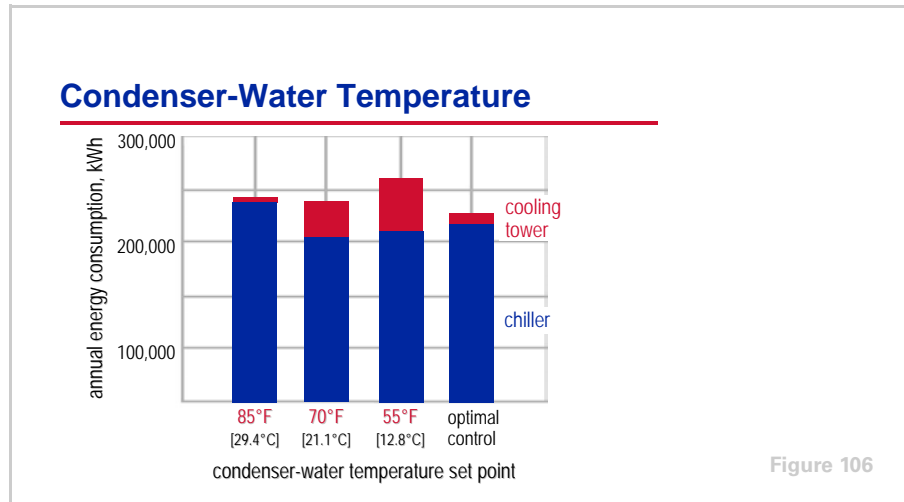

Lowering the temperature of the condenser water can also reduce the energy consumption of the chiller. Depending on the system load and outdoor conditions, cooling towers typically have the ability to supply colder condenser water than at design conditions. This, however, increases the energy consumption of the cooling tower fans. The key to maximizing energy savings is knowing the relationship of cooling-tower energy consumption to chiller energy consumption.

At design conditions, a chiller typically uses five to ten times more energy than a cooling tower. This would suggest that it might be beneficial to use more cooling-tower energy to save chiller energy. However, there is a point of diminishing return where the chiller energy savings is less than the additional energy used by the cooling tower. Figure 106 shows the combined annual energy consumption of a chiller and cooling tower in a system that is controlled to various condenser-water-temperature set points. The third column shows a system that attempts to supply 55°F [12.8°C] water from the cooling tower at all times. Of course, at design conditions, the cooling tower may not be able to supply this temperature, but it will supply the water at the coldest temperature possible.

The fourth column shows a system that uses a control system to dynamically determine the optimal condenser-water temperature that minimizes the combined energy use of the chiller plus cooling tower. It is obvious that this method of optimal control minimizes overall system energy consumption.

period four

Chiller-Plant Control

notes

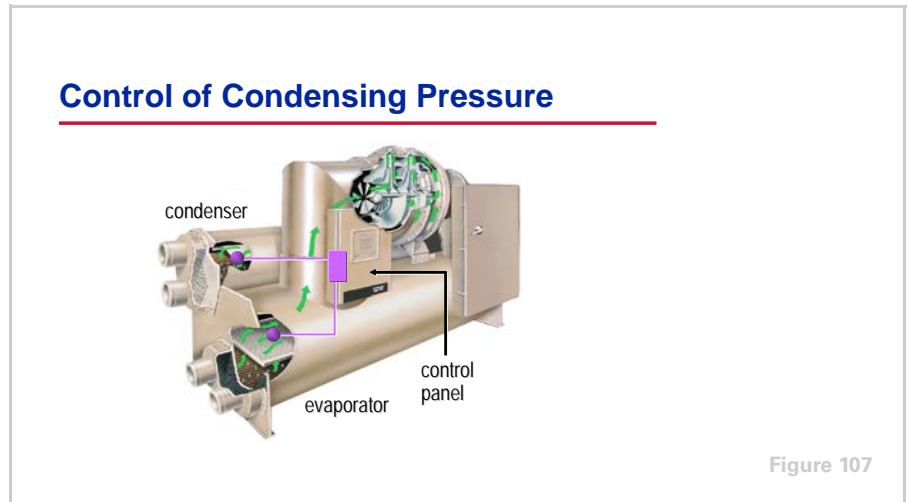

Related to the issue of condenser-water-temperature control is the control of condensing pressure. Every chiller requires a minimum refrigerant-pressure difference between the evaporator and the condenser, in order to ensure that refrigerant and oil circulate properly inside the chiller. This pressure difference varies based on the chiller design and operating conditions. The chiller must develop the required pressure difference within a certain amount of time, as specified by the manufacturer, or the chiller controls will turn it off due to a safety limit. During some start-up conditions, this pressure difference may be difficult to achieve within the time required.

An example of such a condition is an office building that has been unoccupied during a cool autumn weekend. The temperature of the water in the sump of the cooling tower is 40°F [4.4°C]. Monday is sunny and warm, and the building cooling load requires a chiller to be started. Because the chiller is operating at part load and the tower sump is relatively large, the minimum pressure difference may not be reached before the chiller is turned off on a safety. If, however, the flow of water through the condenser is reduced, the minimum pressure difference can be obtained. The lower flow rate increases the temperature of the water leaving the condenser, which results in a higher refrigerant pressure inside the condenser. After the minimum pressure difference is reached, the flow may again be increased.

Either the refrigerant pressure in the condenser or the condenser-evaporator refrigerant-pressure differential can be monitored and used to control the temperature or flow rate of the condenser water, to prevent this pressure differential from dropping below the limit.

period four
Chiller-Plant Control

notes

Operator Training and Support

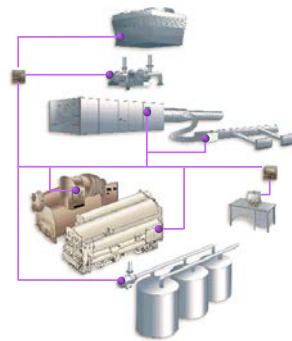

Figure 108

Operator Interface

System-level communication and control is very important. Today, the amount of communication between the components (chillers, cooling towers, pumps, control valves, and so forth) has increased immensely, allowing many chilled-water systems to be fully automated.

In some facilities, however, the largest energy user in the HVAC system (the chiller plant) has not progressed beyond manual control. In some cases it was reduced to manual control shortly after the building was commissioned.

Why does this occur? Chillers are large, with very expensive pieces of equipment which, if damaged by incorrect operation, can cost the owner a substantial amount of money to repair or replace. Operators are, therefore, very sensitive to chiller plant operation. If the operator does not understand how the system is designed and controlled, it is likely that the system will be put into a manual control mode. Therefore, initial and ongoing operator training and support is critical.

period four

Chiller-Plant Control

notes

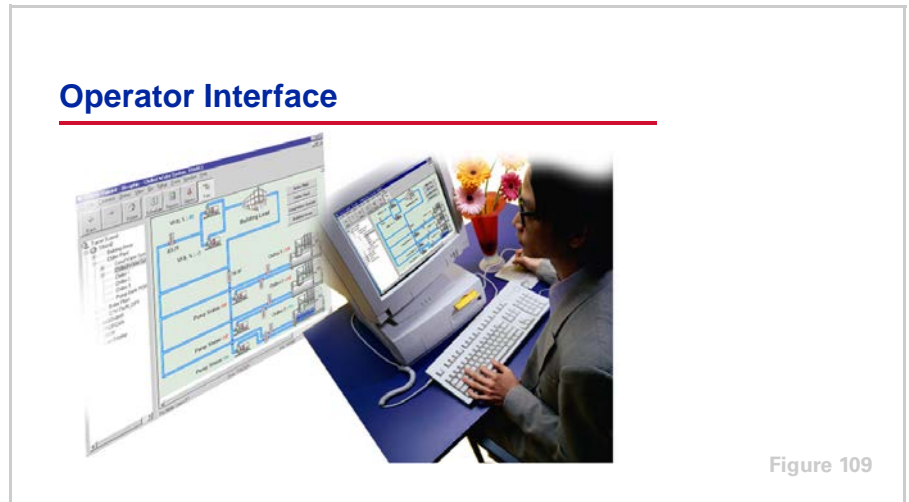

There is an amazing amount of information available within a chilled-water system. Often the problem is not a lack of information, but how to interpret that information. Therefore, a clear and concise interface between the control system and the system operator is extremely important.

Information that should be communicated to the operator includes:

- Chiller-water system temperatures
- Chiller status (on or off)
- Information specified by ASHRAE Guideline 3
- Any pending control actions (chiller about to turn on or off)
- Status of system time delays
- Status of ancillary equipment (pumps, cooling towers, and so forth)

In addition, the chiller-plant control system should notify the operator of problems that are occurring, or are about to occur, in the system. These warning or diagnostic messages may point to a single piece of equipment malfunctioning, or be indicative of system changes that may cause problems. Diagnostics that occur at the chiller control panel should be communicated to the chiller-plant control system.

period four

Chiller-Plant Control

notes

chiller operating log ASHRAE Guideline 3

- Chilled-water inlet and outlet temperatures and pressures
- Chilled water flow
- Evaporator-refrigerant temperature and pressures
- Evaporator approach temperature
- Condenser-water inlet and outlet temperatures and pressures
- Condenser water flow
- Condenser-refrigerant temperature and pressures
- Condenser approach temperature
- Compressor-refrigerant suction and discharge temperatures
- Oil pressures, temperature, and levels
- Refrigerant level
- Vibration levels
- Addition of refrigerant or oil



Figure 110

ASHRAE Guideline 3, *Reducing Emission of Halogenated Refrigerants in Refrigeration and Air Conditioning Equipment and Systems*, includes a list of recommended data points to be logged daily for each chiller. Much of this data may be available from the display on the chiller control panel. It is also helpful to the operator if this information is available at the chiller-plant control system and presented in a clear format.

In addition to current status, historical operating information is valuable for keeping the equipment operating at peak efficiency and for identifying operating trends that signal either impending problems or a drop in system performance. For example, the condenser approach temperature is the temperature difference between the water leaving the condenser and the refrigerant inside the condenser. If there has been a problem with water treatment in the cooling tower, fouling may build up inside the tubes in the chiller condenser. This will cause the difference between the condenser water and refrigerant temperatures to increase, reducing chiller efficiency. By noting an increase in this approach temperature, the operator can schedule cleaning of the condenser tubes. By monitoring system and equipment trends, the operator has a chance to fix minor issues before they cause operational problems.

period five Review

notes

Chilled-Water Systems

period five
Review

Figure 111

We will now review the main concepts that were covered in this clinic on chilled-water systems.

Review—Period One

- **Vapor-compression water chillers**
 - ◆ Air-cooled versus water-cooled
- **Absorption water chillers**
- **Equipment rating standards**
- **ASHRAE/IESNA Standard 90.1-1999**



Figure 112

In Period One, we learned about the different types of vapor-compression and absorption water chillers. Vapor-compression chillers are differentiated primarily by the type of compressor used and whether they use an air-cooled or water-cooled condenser. Absorption chillers are primarily differentiated by whether they are indirectly or directly fired.

We compared the use of air-cooled versus water-cooled chillers. Air-cooled-chiller advantages include lower maintenance costs, a prepackaged system for easier design and installation, and better low-ambient operation. Water-cooled-chiller advantages include greater energy efficiency (at least at design conditions) and longer equipment life.

period five

Review

notes

ARI Standards 550/590 and 560 are common industry standards used for rating water chiller performance. ASHRAE/IESNA Standard 90.1–1999, the energy standard, contains minimum full-load and part-load chiller efficiency requirements, as well as requirements for the design and operation of chilled-water systems.

Review—Period Two

- **Load-terminal control**
 - ◆ Three-way valve
 - ◆ Two-way valve
 - ◆ Face-and-bypass dampers
- **Parallel configuration**
- **Series configuration**
- **Primary-secondary configuration**

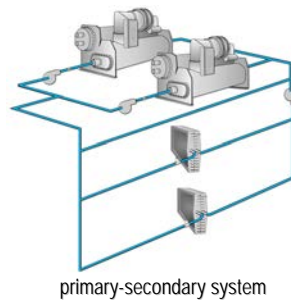

Figure 113

Period Two examined the methods of load-terminal control, including using three-way modulating valves, two-way modulating valves, and face-and-bypass dampers. We then examined several common system configurations, including chillers piped in parallel, in series, and in a primary-secondary arrangement.

The majority of the time was spent discussing the design and operation of the primary-secondary (or decoupled) chilled-water system. The primary-secondary system eliminates many of the hydraulic problems associated with multiple-chiller systems. It provides a reliable and energy-efficient supply of chilled water, and its simplicity and flexibility make it easy to design, expand, and operate.

period five

Review

notes

Review—Period Three

- Hybrid systems
- Low-flow systems
- Variable-primary-flow systems
- Preferential loading
- Heat recovery
- Asymmetric design
- “Free” (reduced-energy) cooling
- Application of a chiller outside its normal operating range

Figure 114

Period Three reviewed several variations in the design of chilled-water systems. These variations may allow the system design engineer to provide added value to the building owner and operator in the areas of improved reliability, greater flexibility, reduced installed costs, and lower operating costs.

Topics included:

- Hybrid chilled-water systems using chillers that operate on different fuels
- Low-flow systems that use lower chilled-water temperatures and lower flow rates
- Variable-primary-flow systems that are designed to vary the water flow through the chiller evaporator
- Configurations that allow a chiller to be preferentially loaded, specifically in the case of a high-efficiency, heat-recovery or alternate-fuel chiller
- Heat-recovery chillers that are capable of providing heat to another part of the system
- Asymmetric system designs using chillers of different capacities or efficiencies, such as the “swing” chiller concept
- Several “free” cooling options that reduce cooling energy costs
- Applications in which the required conditions are outside of the normal operating range of the chiller

period five

Review

notes

Review—Period Four

- Chiller sequencing
- Failure recovery
- Contingency planning
- System tuning
- System optimization
- Operator interface

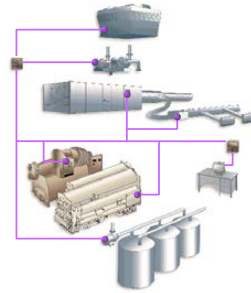

Figure 115

Period Four discussed the issues related to chiller-plant control, including chiller sequencing, failure recovery, contingency planning, system tuning, and system-level optimization.

Remember that you cannot “control your way out of” a poor system design. Although the control system can attempt to minimize the impact of a poor design, it cannot eliminate the cause of the poor design.

Second, even a properly installed system with good components requires system-level control to make those components work together effectively.

Third, even if the components are working together, the system, not the individual components, needs to be optimized. Remember: the meter is on the building.

Finally, a very important issue that is related to chiller-plant control is the issue of interfacing with the person who is operating the system. Simplicity is important, and it gives the system a much better chance of working without intervention by the operator.

period five

Review

notes



For more information, refer to the following references:

- *Multiple-Chiller-System Design and Control Applications Engineering Manual* (Trane literature order number SYS-APM001-EN)
- *Refrigeration Cycle Air Conditioning Clinic* (Trane literature order number TRG-TRC003-EN)
- *Refrigeration Compressors Air Conditioning Clinic* (Trane literature order number TRG-TRC004-EN)
- *Centrifugal Water Chillers Air Conditioning Clinic* (Trane literature order number TRG-TRC010-EN)
- *Absorption Water Chillers Air Conditioning Clinic* (Trane literature order number TRG-TRC011-EN)
- *Helical-Rotary Water Chillers Air Conditioning Clinic* (Trane literature order number TRG-TRC012-EN)
- *ASHRAE Handbook – Refrigeration*
- *ASHRAE Handbook – Systems and Equipment*

Visit the ASHRAE Bookstore at www.ashrae.org.

For information on additional educational materials available from Trane, contact your local Trane sales office (request a copy of the Educational Materials price sheet—Trane order number EM-ADV1) or visit our online bookstore at www.trane.com/bookstore/.

Quiz

Questions for Period 1

- 1 What are the four types of compressors commonly used in vapor-compression water chillers?
- 2 List one advantage of an air-cooled chiller and one advantage of a water-cooled chiller.
- 3 True or False: The IPLV equation included in the ARI standards for rating chillers was derived to provide a representation of the average part-load efficiency for a system with *multiple* chillers.

Questions for Period 2

- 4 What are the three most common methods of load-terminal (coil) control?

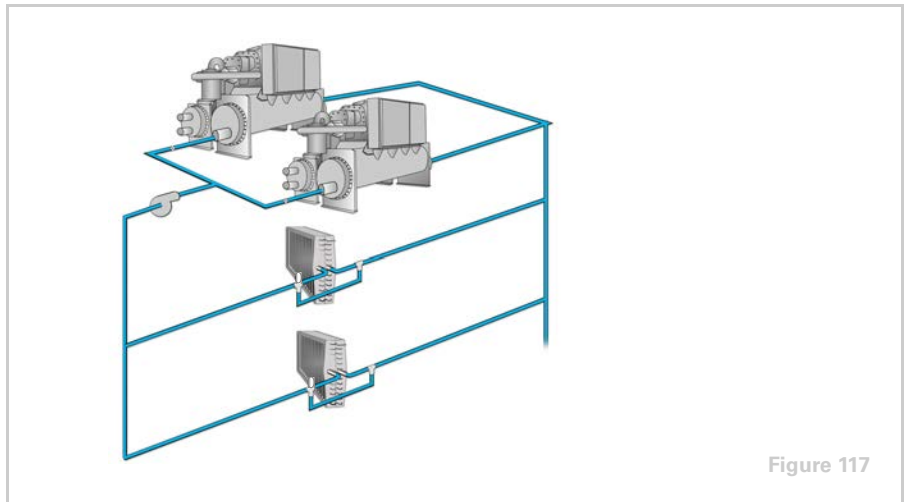

Figure 117

- 5 The system shown in Figure 117 contains two chillers piped in parallel with a single, constant-volume pump. What is the drawback of this system configuration when only one chiller is operating?
- 6 In a conventional primary-secondary chilled-water system, each production pump delivers a _____ (constant or variable) flow of water and the distribution pump delivers a _____ (constant or variable) flow of water.
- 7 What method of load-terminal control should be used in the distribution loop of a primary-secondary chilled-water system?
- 8 Deficit flow in the bypass pipe of a primary-secondary system is an indication to turn an additional chiller _____ (on or off).

Quiz

Questions for Period 3

- 9** Why does a variable-primary-flow (VPF) system require a bypass in the system?
- 10** Identify one scenario where preferential loading is beneficial to a chilled-water system.
- 11** What is the benefit of using a smaller-capacity “swing” chiller in a multiple-chiller system?

Questions for Period 4

- 12** Making decisions about when to turn chillers on and off is commonly referred to as chiller _____.
- 13** Lowering the temperature of the water leaving the cooling tower _____ (increases or decreases) the energy consumption of the chiller and _____ (increases or decreases) the energy consumption of the cooling tower fans.
- 14** An increase in the condenser approach temperature (that is, the temperature difference between the water and the refrigerant inside the condenser) may be a sign of what?

Answers

- 1** Centrifugal, helical-rotary, reciprocating, and scroll
- 2** Air-cooled chiller advantages include lower maintenance costs, a pre-packaged system for easier design and installation, and better low-ambient operation. Water-cooled chiller advantages include greater energy efficiency (at least at design conditions) and longer equipment life.
- 3** False. The IPLV equation was derived to provide a representation of the average part-load efficiency for a *single-chiller system only*.
- 4** Three-way modulating control valve, two-way modulating control valve, and face-and-bypass dampers
- 5** When only one chiller is operating, warm return water continues to flow through the non-operating chiller and mixes with the chilled water leaving the operating chiller. The temperature of the mixture of these two streams is higher than the desired supply-water temperature, possibly resulting in building comfort or space humidity control problems.
- 6** Constant; variable
- 7** Two-way modulating control valves
- 8** Turn on
- 9** To ensure that the water flow through the system remains above the minimum flow limit of the operating chiller(s)
- 10** Preferential loading is typically most beneficial in the following scenarios:
 - In a system that has a high-efficiency chiller along with several standard-efficiency chillers, the high-efficiency chiller can be preferentially loaded to reduce system energy consumption.
 - In a system with a heat-recovery chiller, preferentially loading the heat-recovery chiller maximizes the amount of heat recovered, thus reducing the overall system energy consumption.
 - In a system with an alternate-fuel chiller, such as an absorption chiller, preferentially loading the alternate-fuel chiller during times of high electricity costs minimizes system energy cost.
- 11** The swing chiller is alternated on and off between the larger chillers' operation, in order to serve as a smaller incremental step of loading. This sequence more favorably matches the capacity of the chiller plant to the system load and operates the fewest, and smallest, pieces of ancillary equipment (pumps and cooling towers) at any system load.

Answers

12 Sequencing

13 Decreases; increases

14 Fouling inside the tubes of the condenser, possibly indicating a problem with water treatment in the cooling tower

Glossary

absorbent A substance used to absorb refrigerant and transport it from the low-pressure to the high-pressure side of the absorption refrigeration cycle. In absorption water chillers, the absorbent is commonly lithium bromide.

absorber A component of the absorption refrigeration cycle in which refrigerant vapor is absorbed by the absorbent solution and rejects heat to cooling water.

air-cooled condenser A type of condenser in which refrigerant flows through the tubes and rejects heat to air that is drawn across the tubes.

airside economizer A method of free cooling that involves using cooler outdoor air for cooling instead of recirculating warmer indoor air.

ARI Air-Conditioning and Refrigeration Institute

ARI Standard 550/590 A publication titled *Standard for Water Chilling Packages Using the Vapor-Compression Cycle* that promotes consistent rating and testing methods for all types and sizes of water chillers. It covers factory-designed, prefabricated water chillers, both air-cooled and water-cooled, using the vapor-compression refrigeration cycle.

ARI Standard 560 A publication titled *Absorption Water Chilling and Water Heating Packages* that promotes consistent rating methods for many types and sizes of absorption water chillers in which water is the refrigerant and lithium bromide is the absorbent. It covers single-effect chillers operating on steam or a hot fluid; indirect-fired double-effect chillers operating on steam or a hot fluid; and direct-fired double-effect chillers operating on natural gas, oil, or liquid petroleum (LP).

ASHRAE American Society of Heating, Refrigerating and Air-Conditioning Engineers

ASHRAE Guideline 3 A publication titled *Reducing Emission of Halogenated Refrigerants in Refrigeration and Air Conditioning Equipment and Systems* that includes a recommended list of data points to be logged daily for each water chiller.

ASHRAE Standard 15 A publication titled *Safety Code for Mechanical Refrigeration* that specifies safe design, construction, installation, and operation of refrigerating systems.

ASHRAE/IESNA Standard 90.1 A publication titled *Energy Standard for Buildings, Except Low-Rise Residential Buildings* that provides minimum requirements for the energy-efficient design of buildings (except low-rise residential buildings), including the HVAC system.

centrifugal compressor A type of compressor that uses centrifugal force, generated by a rotating impeller, to compress the refrigerant vapor.

Glossary

chilled-water system Uses water as the cooling media. The refrigerant inside the evaporator absorbs heat from the water, and this water is pumped to coils in order to absorb heat from the air used for space conditioning.

coefficient of performance (COP) A dimensionless ratio used to express the efficiency of a refrigeration machine. A higher COP designates a higher efficiency. For an electric chiller, it is defined as evaporator cooling capacity divided by the electrical energy input. For an absorption water chiller, it is defined as evaporator cooling capacity divided by the heat energy required by the generator, excluding the electrical energy needed to operate the pumps, purge, and controls.

compressor A mechanical device used in the vapor-compression refrigeration cycle to increase the pressure and temperature of the refrigerant vapor.

condenser A component of the refrigeration cycle in which refrigerant vapor is converted to liquid as it rejects heat to air, water, or some other fluid.

cooling tower A device used to reject the heat from a water-cooled condenser by spraying the condensing water over the fill while drawing outdoor air upward through the fill.

decoupled system See primary-secondary system.

deficit flow A condition in a primary-secondary chilled-water system in which the production loop provides less flow than is required by the distribution loop. To make up for this deficit, water travels from the return side of the distribution loop, through the bypass pipe, and mixes with the water supplied by the production loop.

direct-fired A type of absorption chiller that uses the combustion of a fossil fuel (such as natural gas or oil) directly to provide heat to the high-temperature generator.

double-effect A type of absorption chiller that uses two generators, a high-temperature generator and a low-temperature generator.

evaporator A component of the refrigeration cycle where cool, liquid refrigerant absorbs heat from air, water, or some other fluid, causing the refrigerant to boil.

excess flow A condition in a primary-secondary chilled-water system in which the production loop is providing more flow than is required by the distribution loop. This excess water travels from the supply side of the production loop, through the bypass pipe, and mixes with the water returning from the distribution loop.

expansion device A component of the refrigeration cycle used to reduce the pressure and temperature of the refrigerant to the evaporator conditions.

Glossary

expansion tank A component of a closed piping system that accommodates the expansion and contraction of the water as temperature and, therefore, density, changes.

fouling Minerals in the water that form scaling on the internal surfaces of the heat exchanger tubes.

generator A component of the absorption refrigeration cycle in which refrigerant vapor boils and is separated from the absorbent solution as it absorbs heat from the primary heat source.

heat recovery The process of capturing the heat that is normally rejected from the chiller condenser and using it for space heating, domestic water heating, or another process seems unnecessary.

helical-rotary (screw) compressor A type of compressor that uses two mated rotors to trap the refrigerant vapor and compress it by gradually shrinking the volume of the refrigerant.

hybrid system A chilled-water system that can use more than one type of fuel.

indirect-fired A type of absorption chiller that uses steam or a hot fluid (such as water) from an external source to provide heat to the generator.

Integrated Part-Load Value (IPLV) An equation that predicts chiller efficiency at the ARI standard rating conditions, using weighted-average load curves that represent a broad range of geographic locations, building types, and operating-hour scenarios, both with and without an air side economizer.

Nonstandard Part-Load Value (NPLV) An equation that predicts chiller efficiency at nonstandard rating conditions, using weighted-average load curves that represent a broad range of geographic locations, building types, and operating-hour scenarios, both with and without an air side economizer.

primary-secondary (decoupled) system A configuration of a multiple-chiller system that uses separate production and distribution pumps to hydraulically decouple the production capacity of the chillers from the load of the distribution system.

reciprocating compressor A type of compressor that uses a piston that travels up and down inside a cylinder to compress the refrigerant vapor.

refrigerant migration A method of free cooling that allows the chiller to be used as a heat exchanger without operation of the compressor. It is possible, when the condensing temperature of the refrigerant is low enough, for refrigerant to migrate from the evaporator to the condenser.

scroll compressor A type of compressor that uses two opposing scrolls to trap the refrigerant vapor and compress it by gradually shrinking the volume of the refrigerant.

single-effect A type of absorption chiller that uses a single generator.

Glossary

notes

swing chiller A smaller-capacity chiller used in a multiple-chiller system. It is alternated on and off between the larger chillers' operation to serve as a smaller, incremental step of loading.

variable-primary-flow (VPF) system A type of chilled-water system that is designed to vary the flow of water throughout the entire system—through the evaporator of each operating chiller as well as through the cooling coils.

variable-speed drive A device used to vary the capacity of a centrifugal pump by varying the speed of the motor that rotates the pump impeller.

water-cooled condenser A type of condenser in which water flows through the tubes and absorbs heat from the refrigerant that fills the surrounding shell.



Trane optimizes the performance of homes and buildings around the world. A business of Ingersoll Rand, the leader in creating and sustaining safe, comfortable and energy efficient environments, Trane offers a broad portfolio of advanced controls and HVAC systems, comprehensive building services, and parts. For more information, visit www.Trane.com.

Trane has a policy of continuous product and product data improvement and reserves the right to change design and specifications without notice.

© 2012 Trane All rights reserved
TRG-TRC016-EN 24 Aug 2012
Supersedes TRG-TRC016-EN (Feb 2004)

We are committed to using environmentally
conscious print practices that reduce waste.

